

Darwin 6x6

User Manual

November 2020 draft

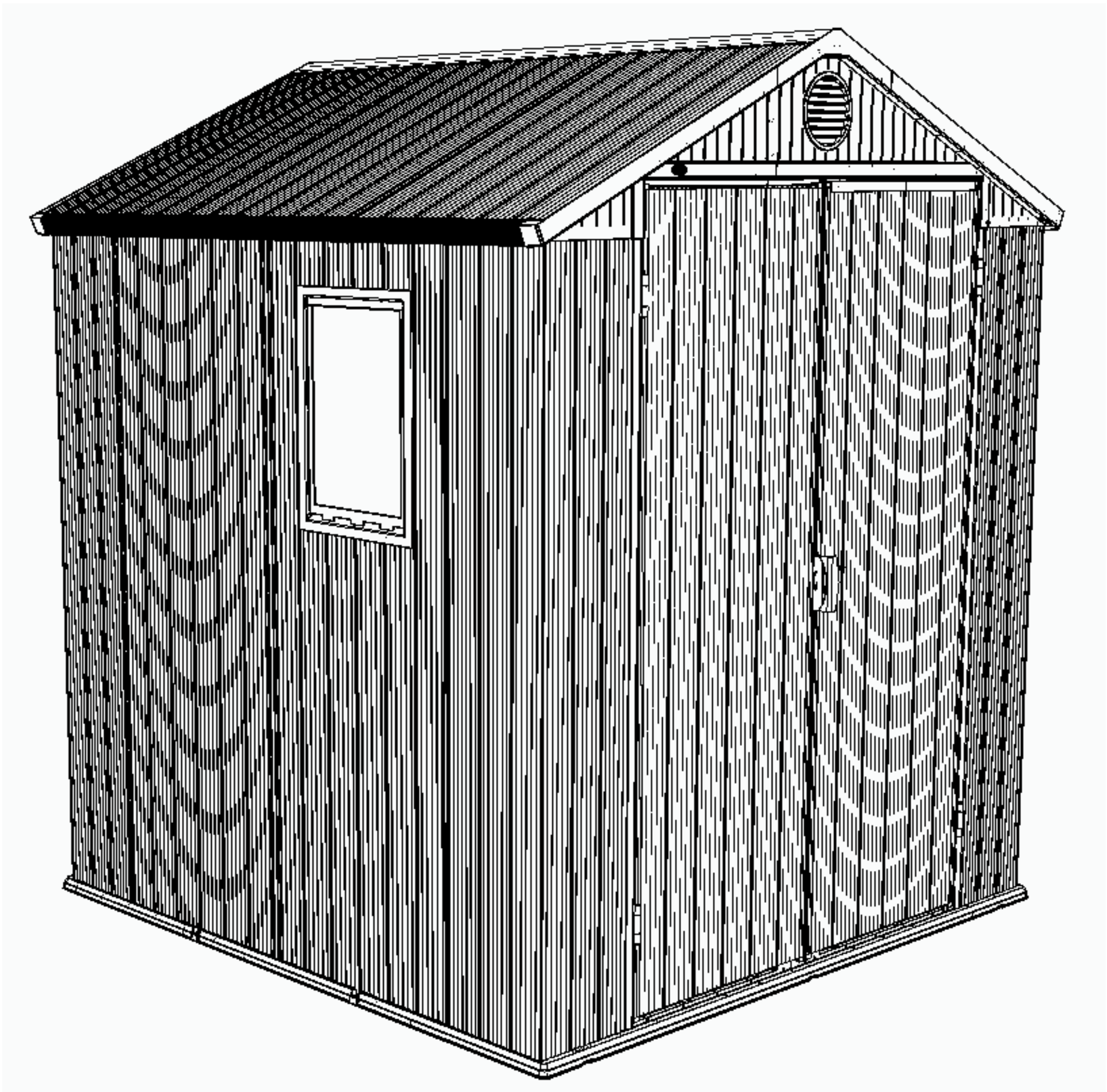

1

DREF x 2

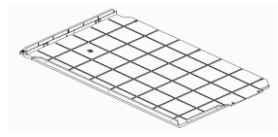

Floor assembly

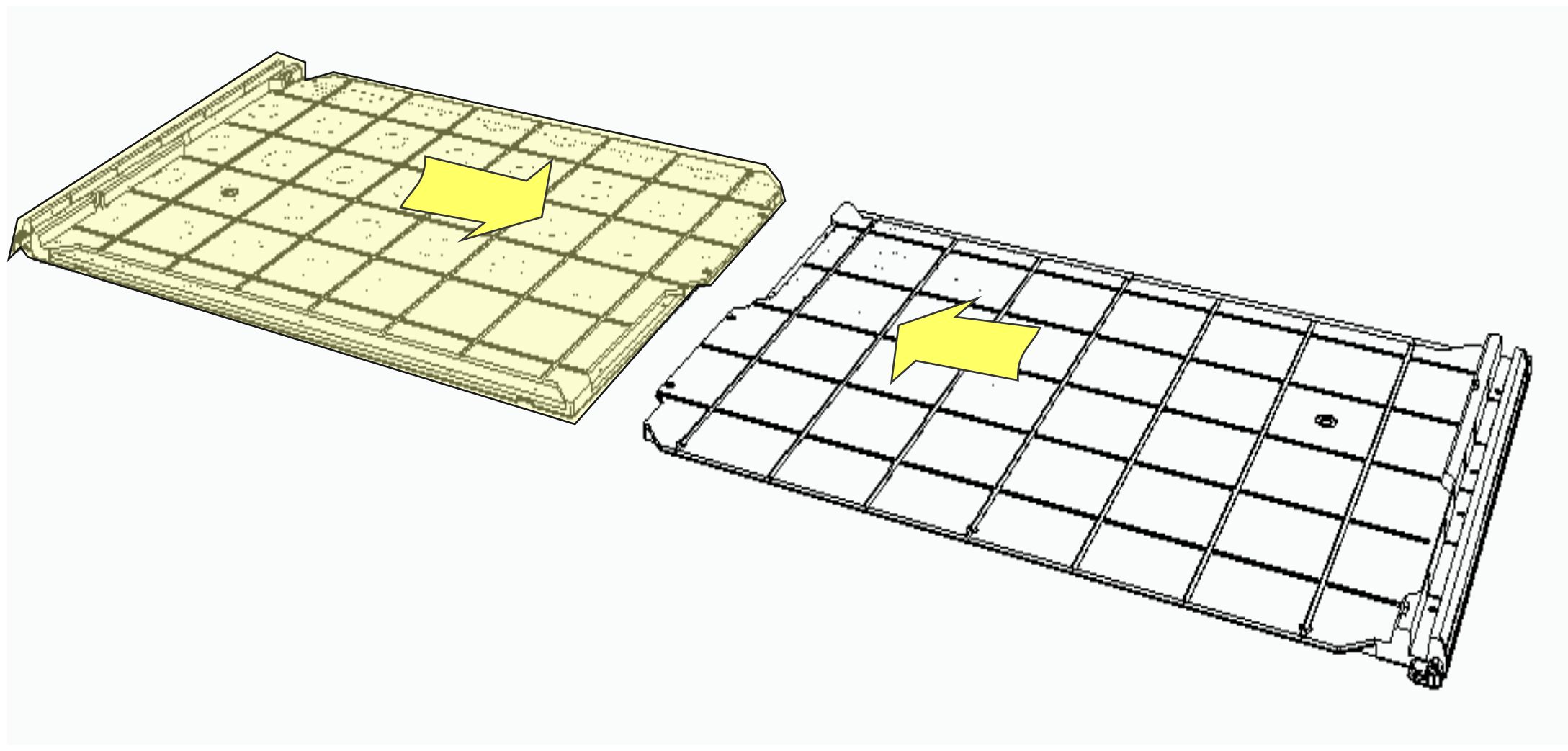

Sc12t x 4

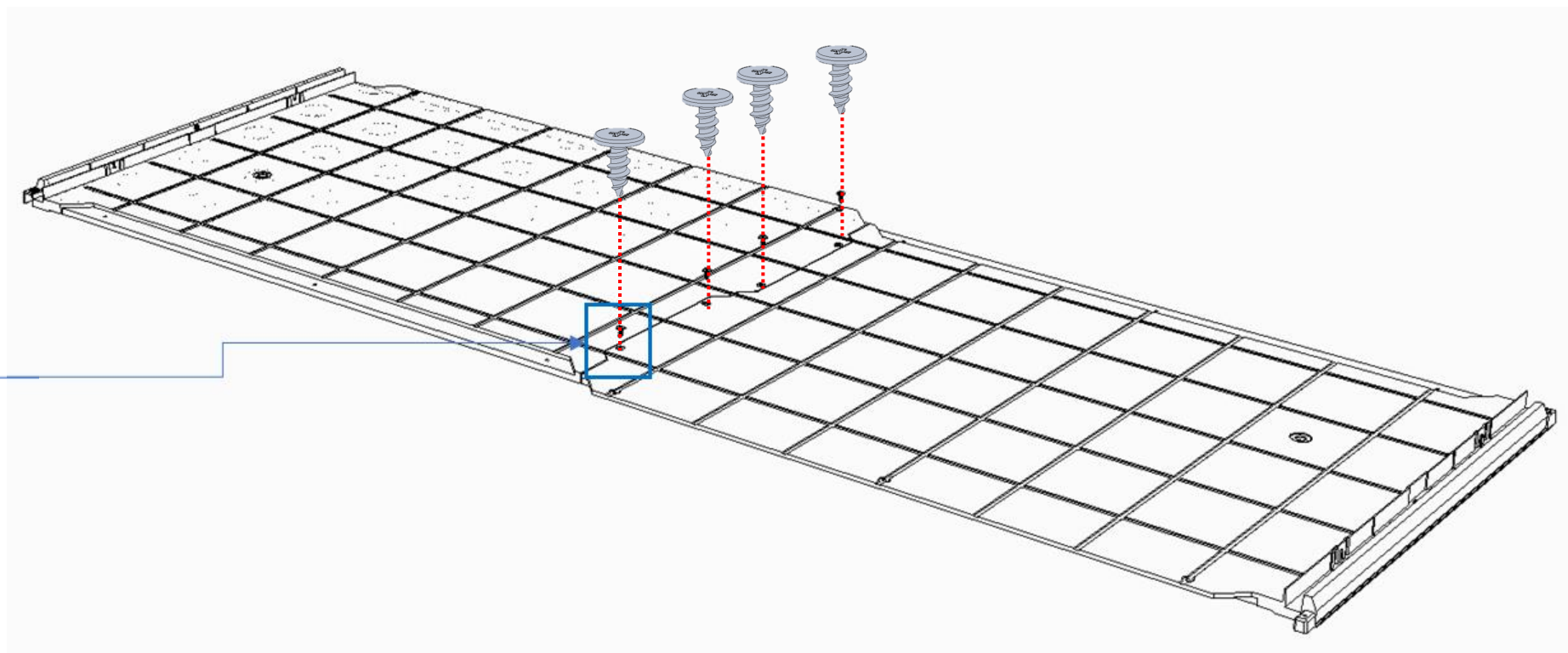
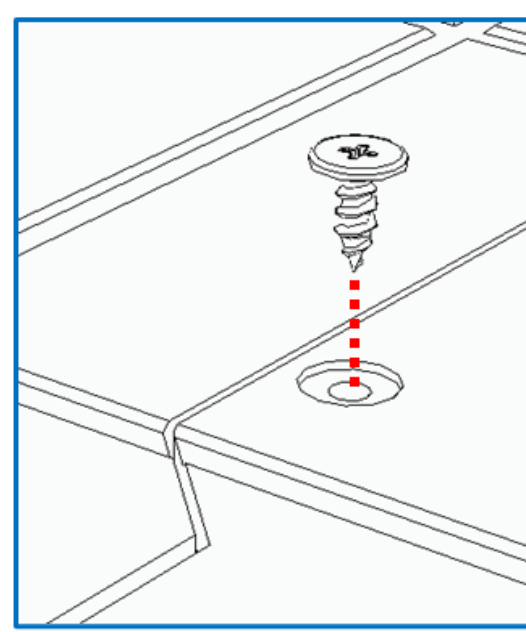
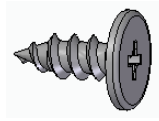

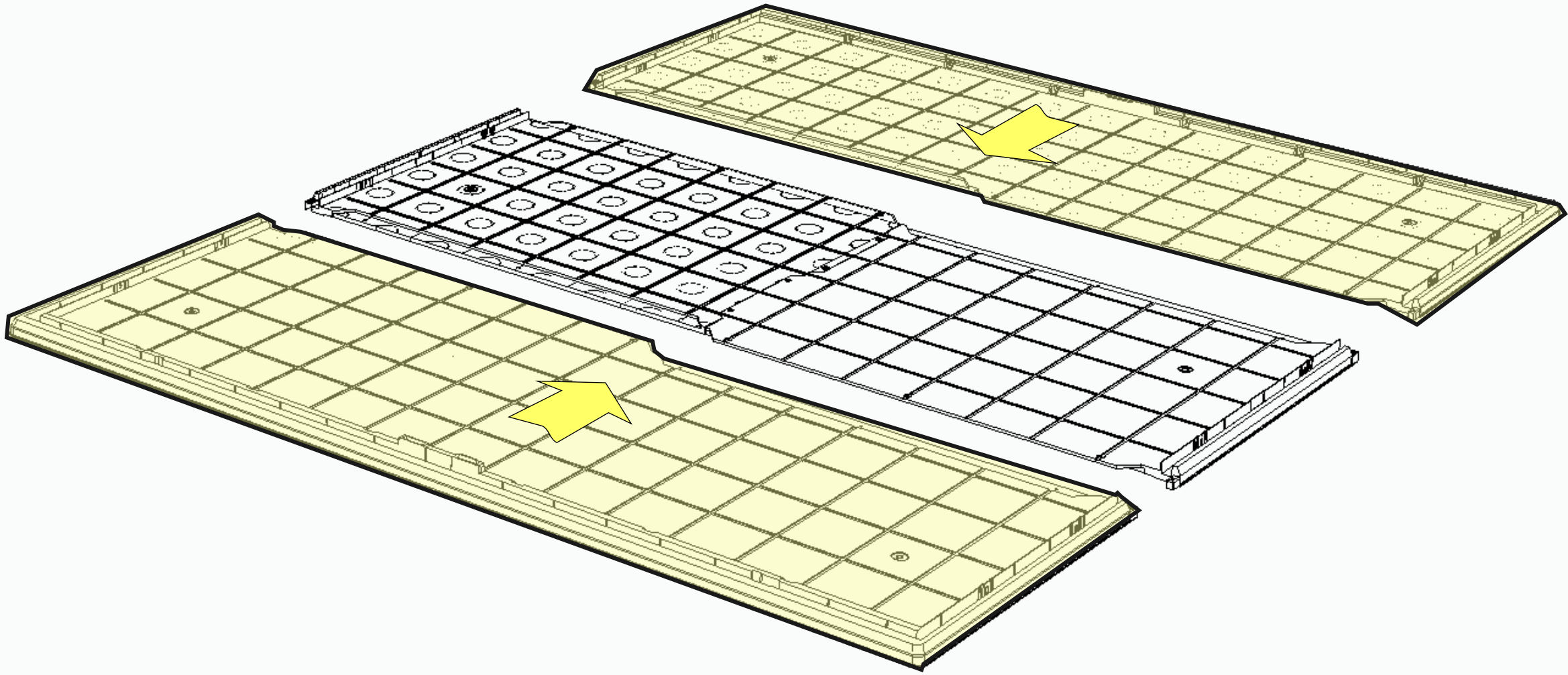

Sc12t x 16

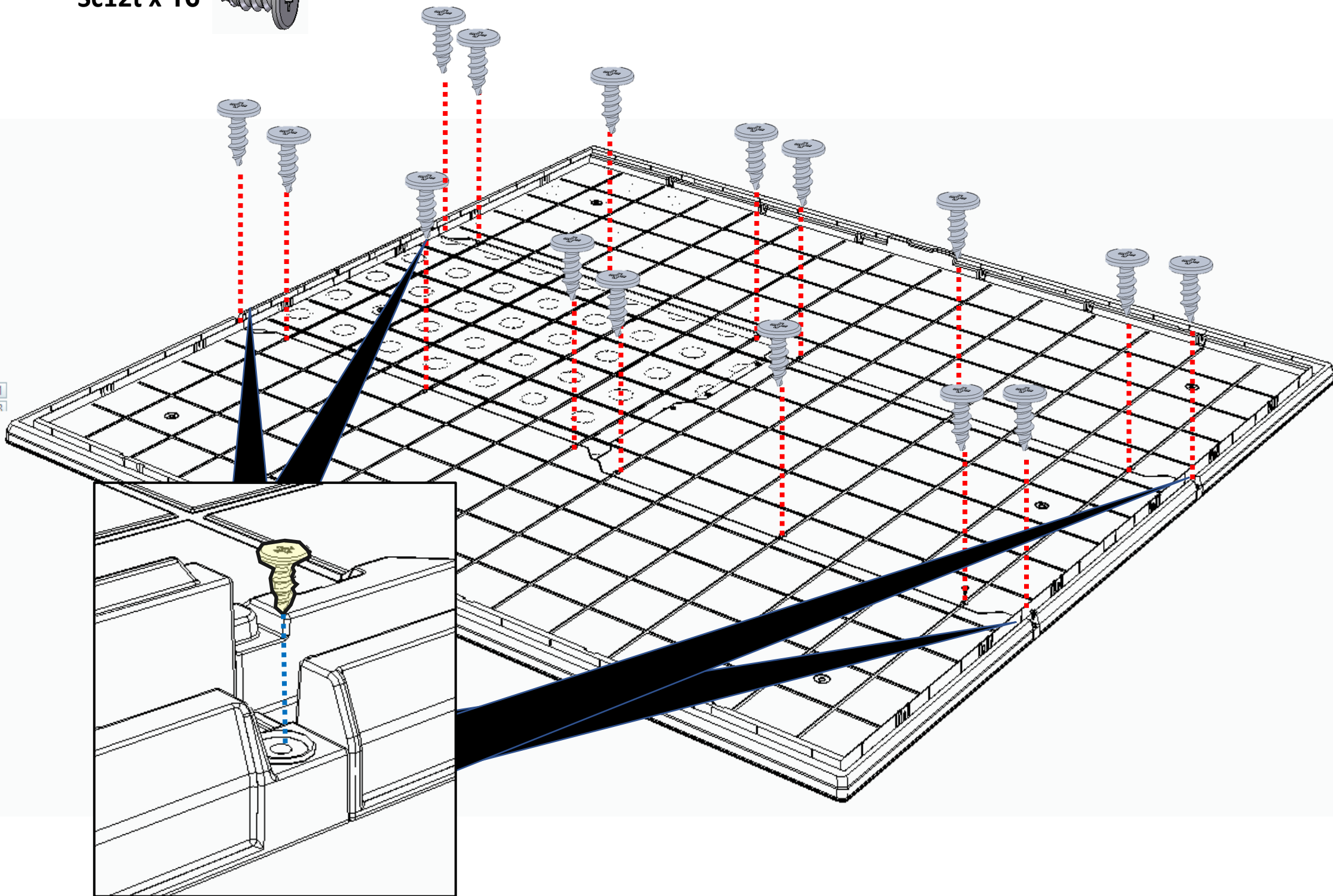
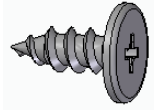

3

DRCP x 1

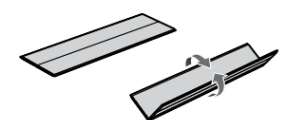

Walls assembly

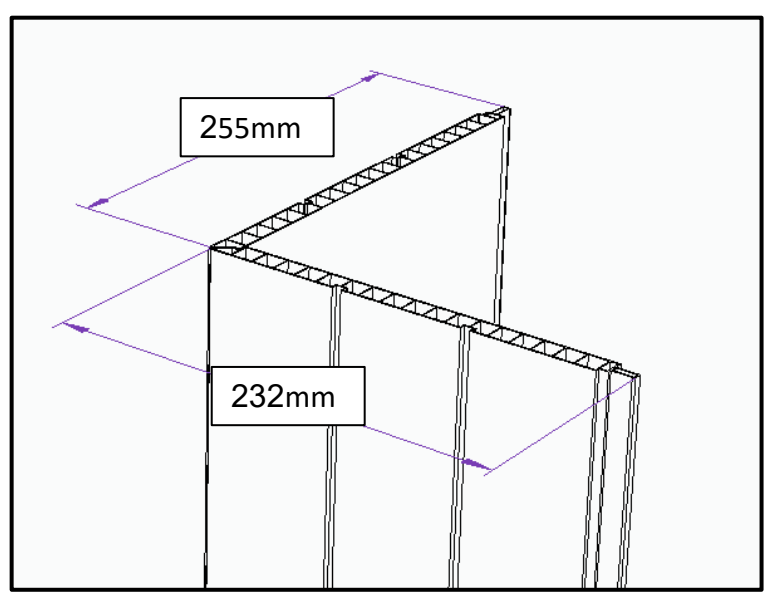

Asymmetric

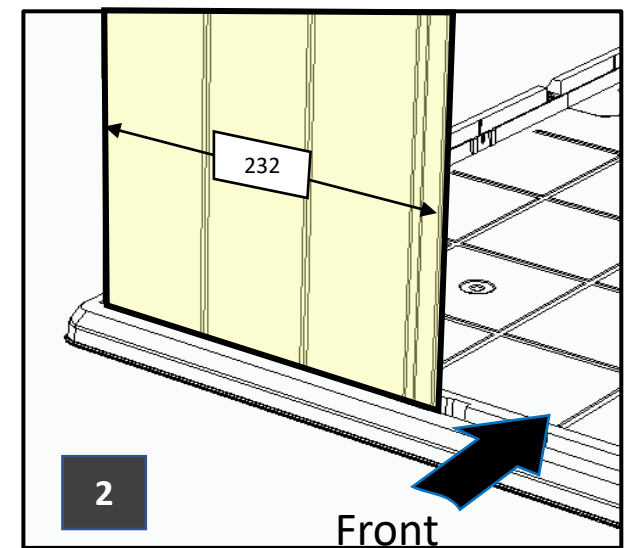
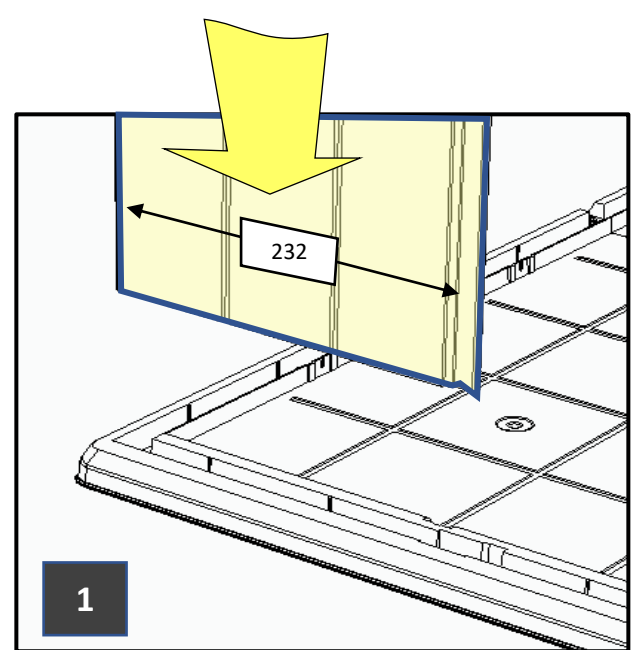

Front left's corner first

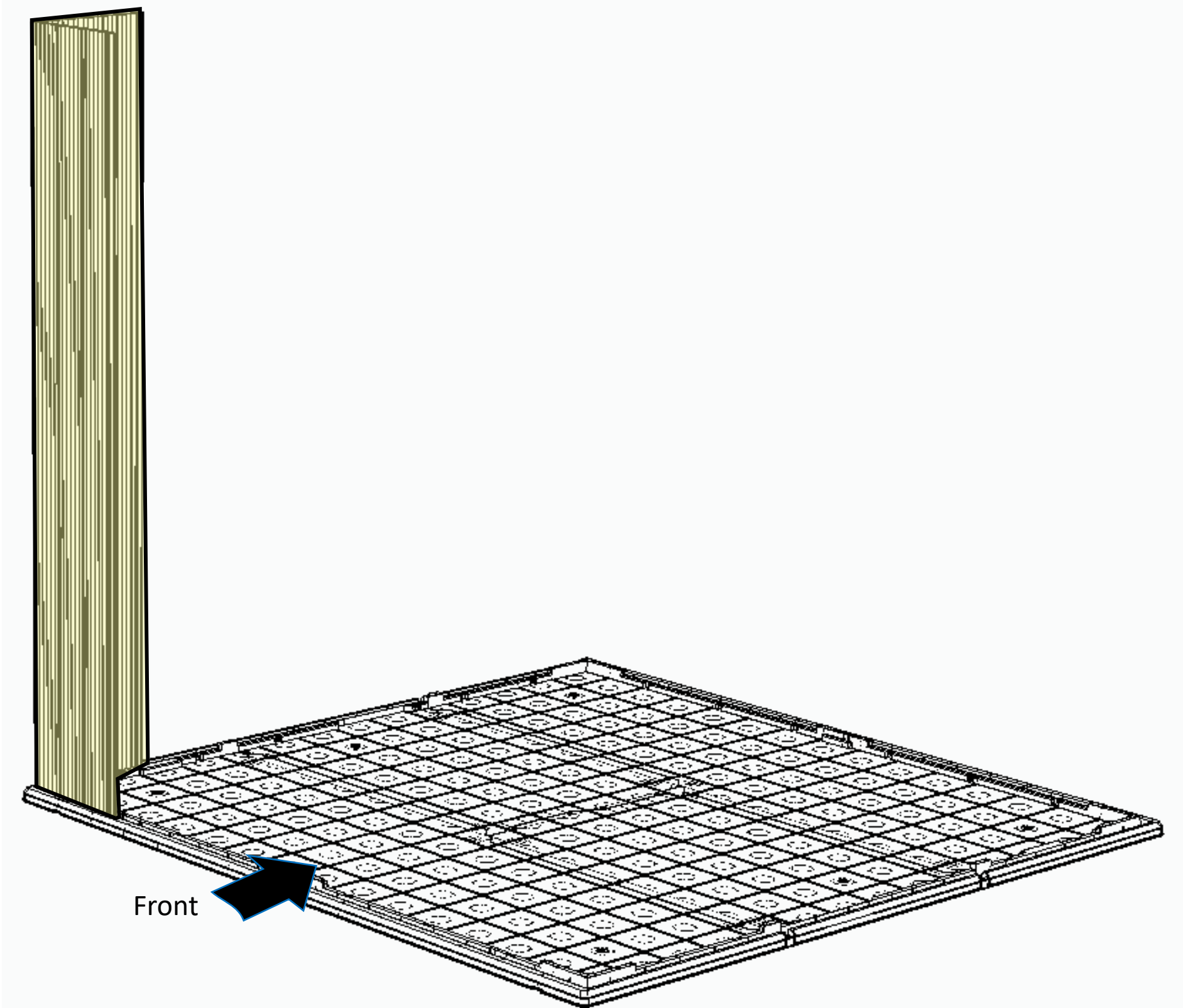

4

DRPW (X1)

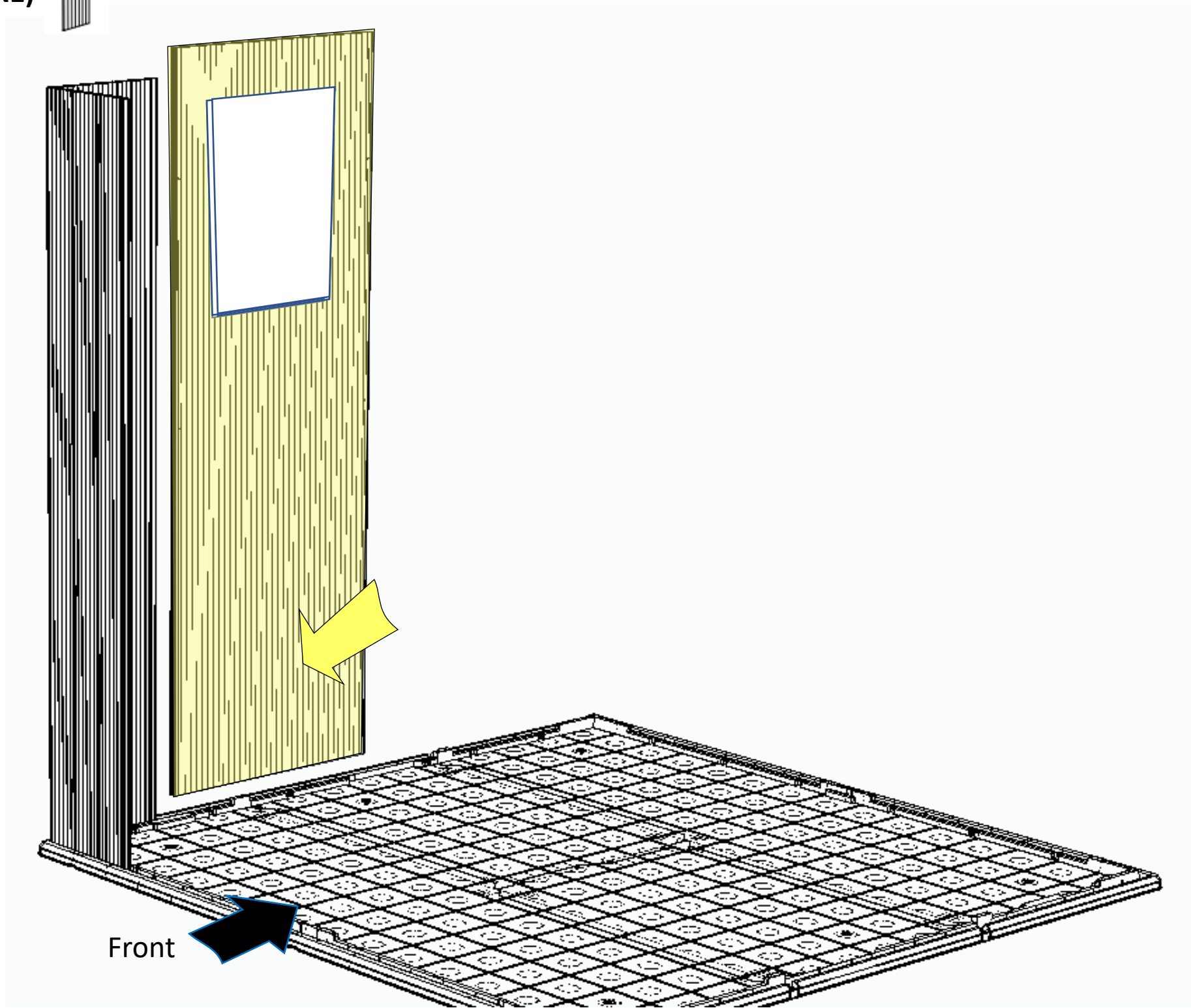

5

Sc12t x 3

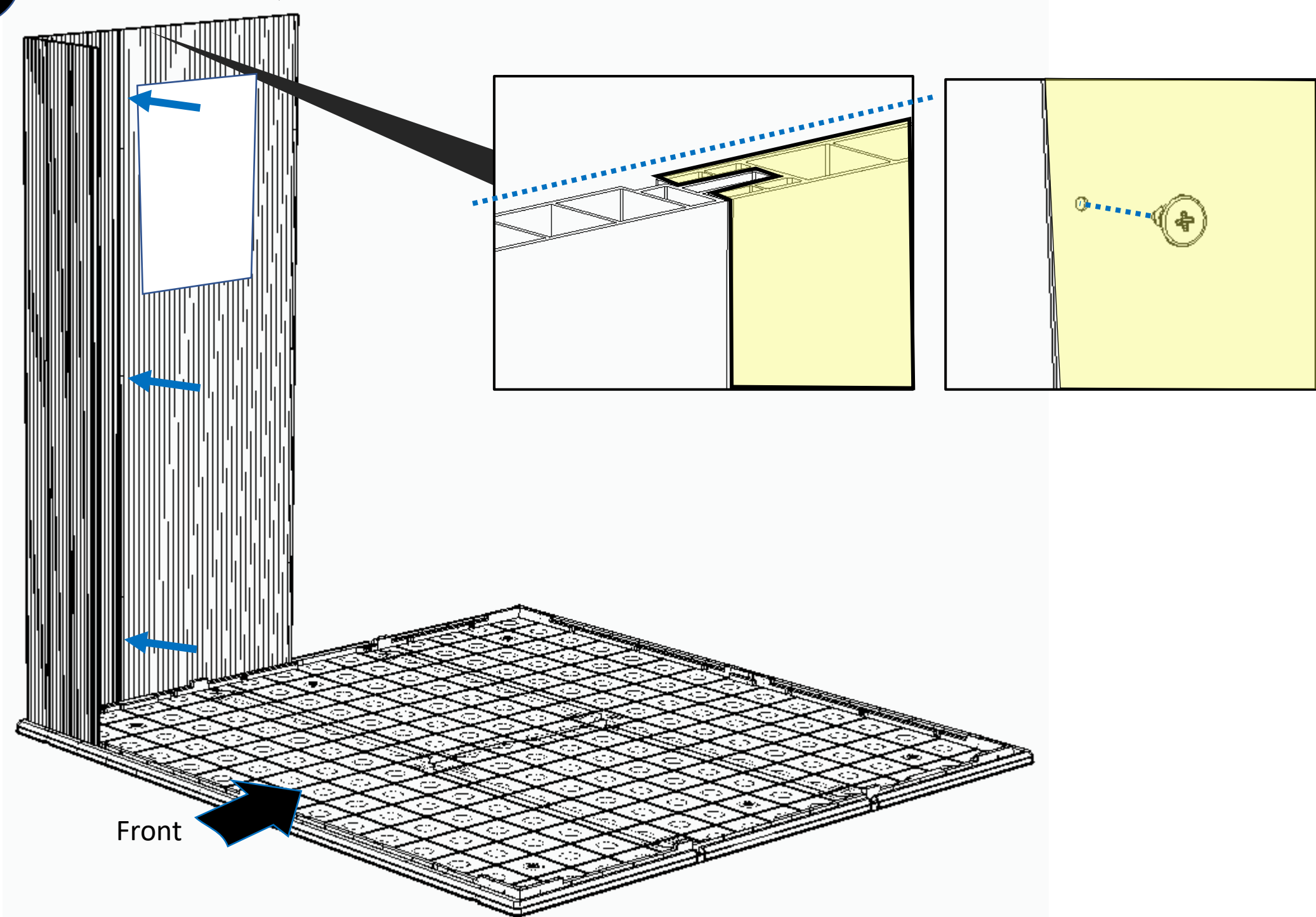
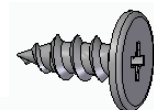

6

DRMDD (x1)

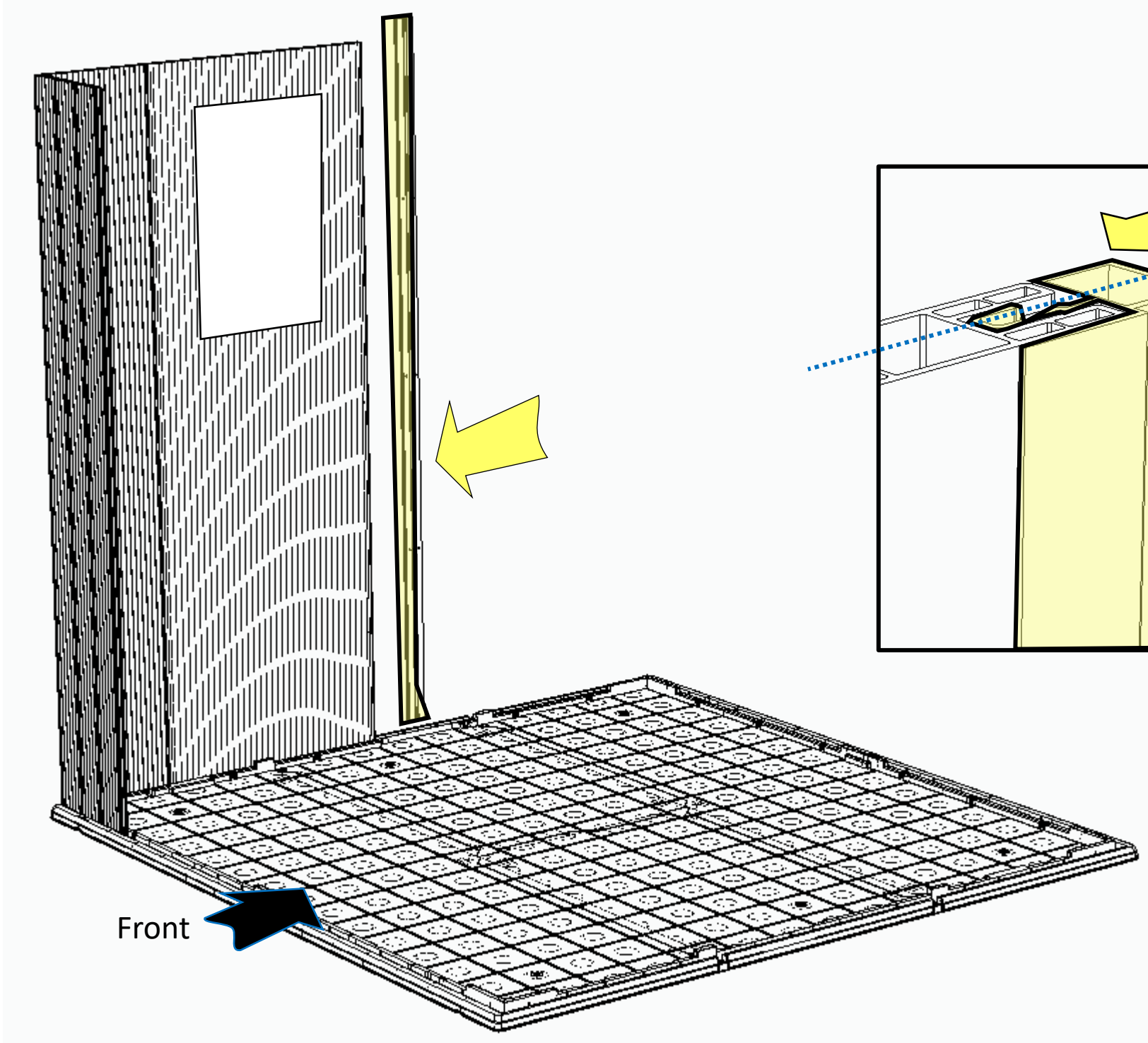
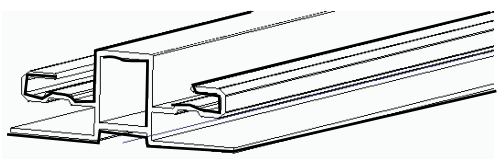

Sc7t (x3)

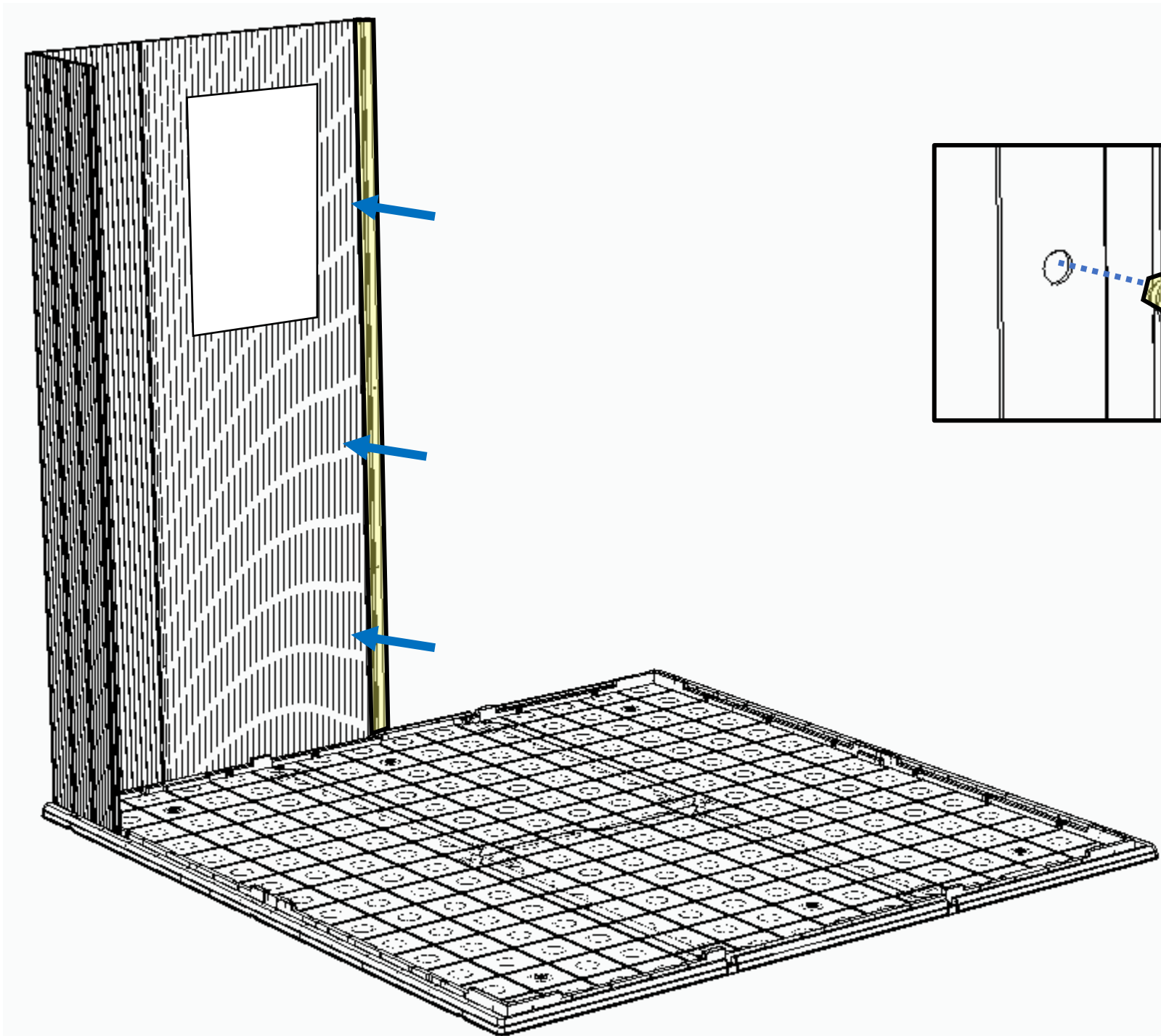
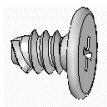

7

DRPS (X1)

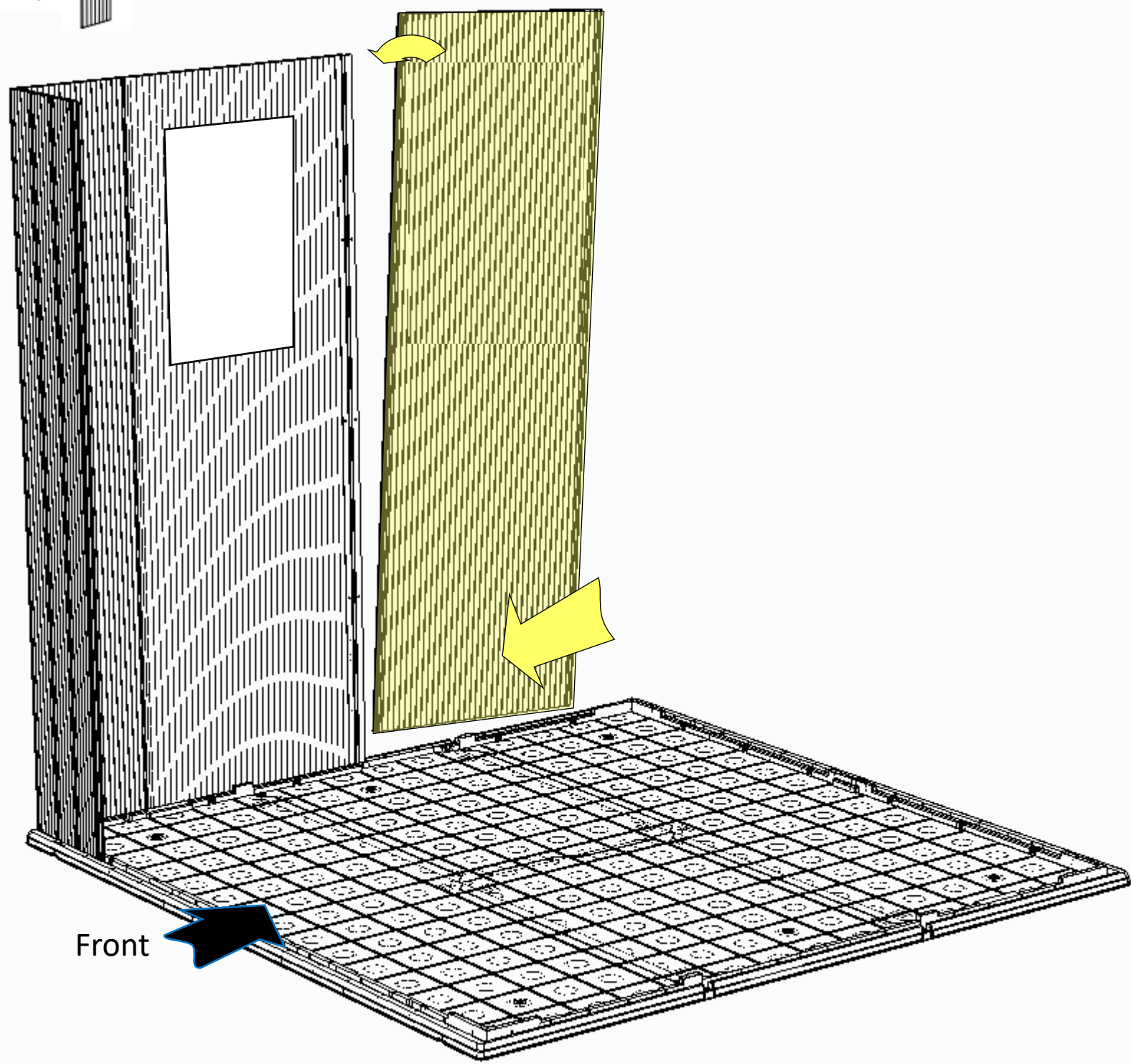
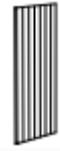

Sc7t (x3)

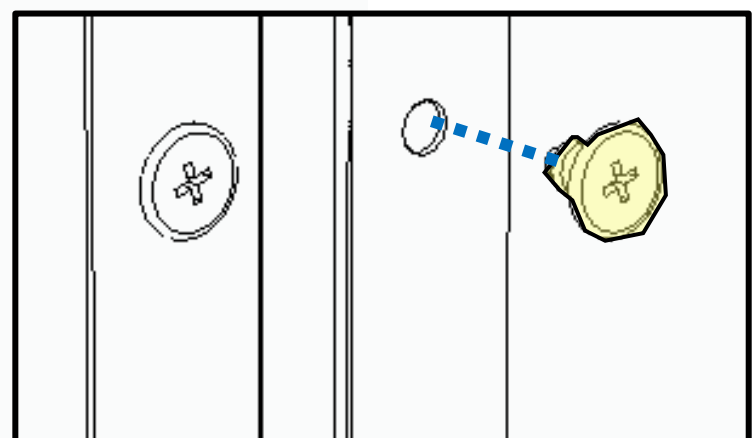
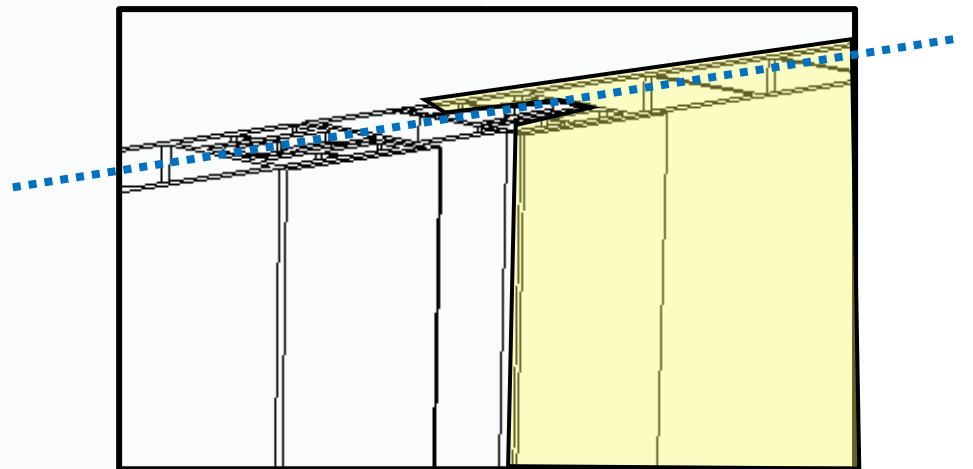
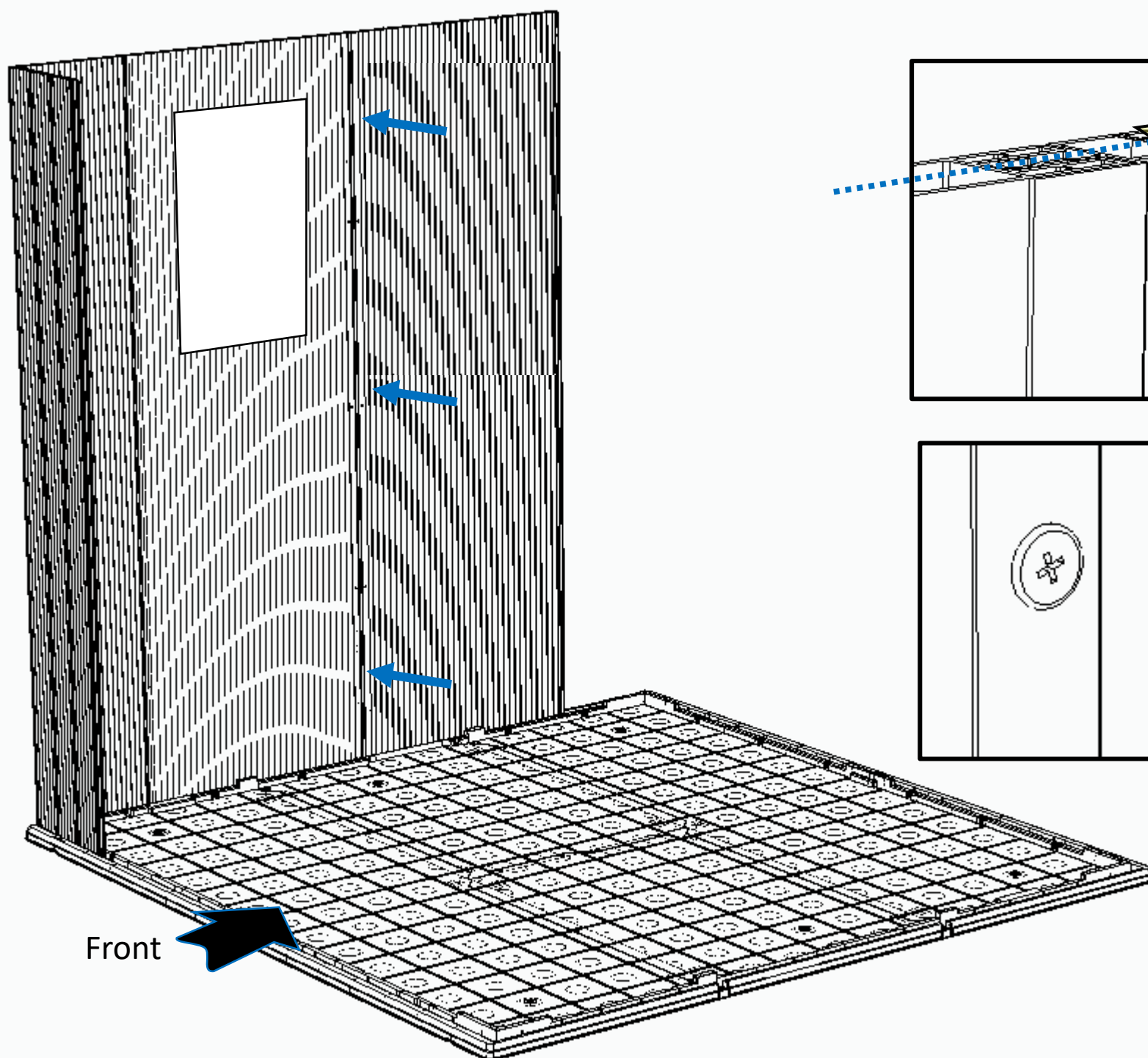
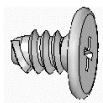

8

DRCP x 1

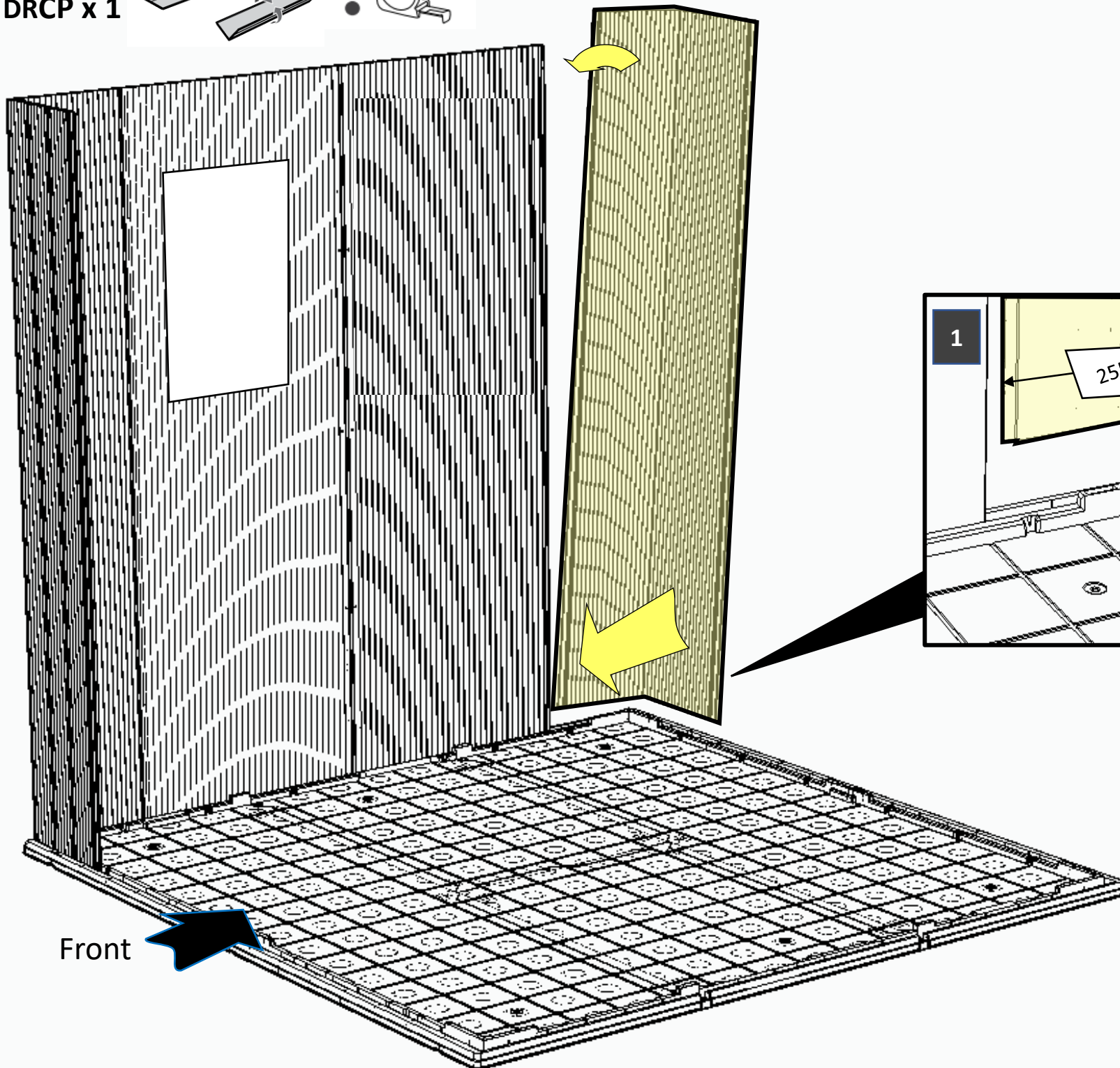
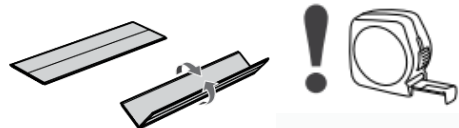

Sc12t (x 3)

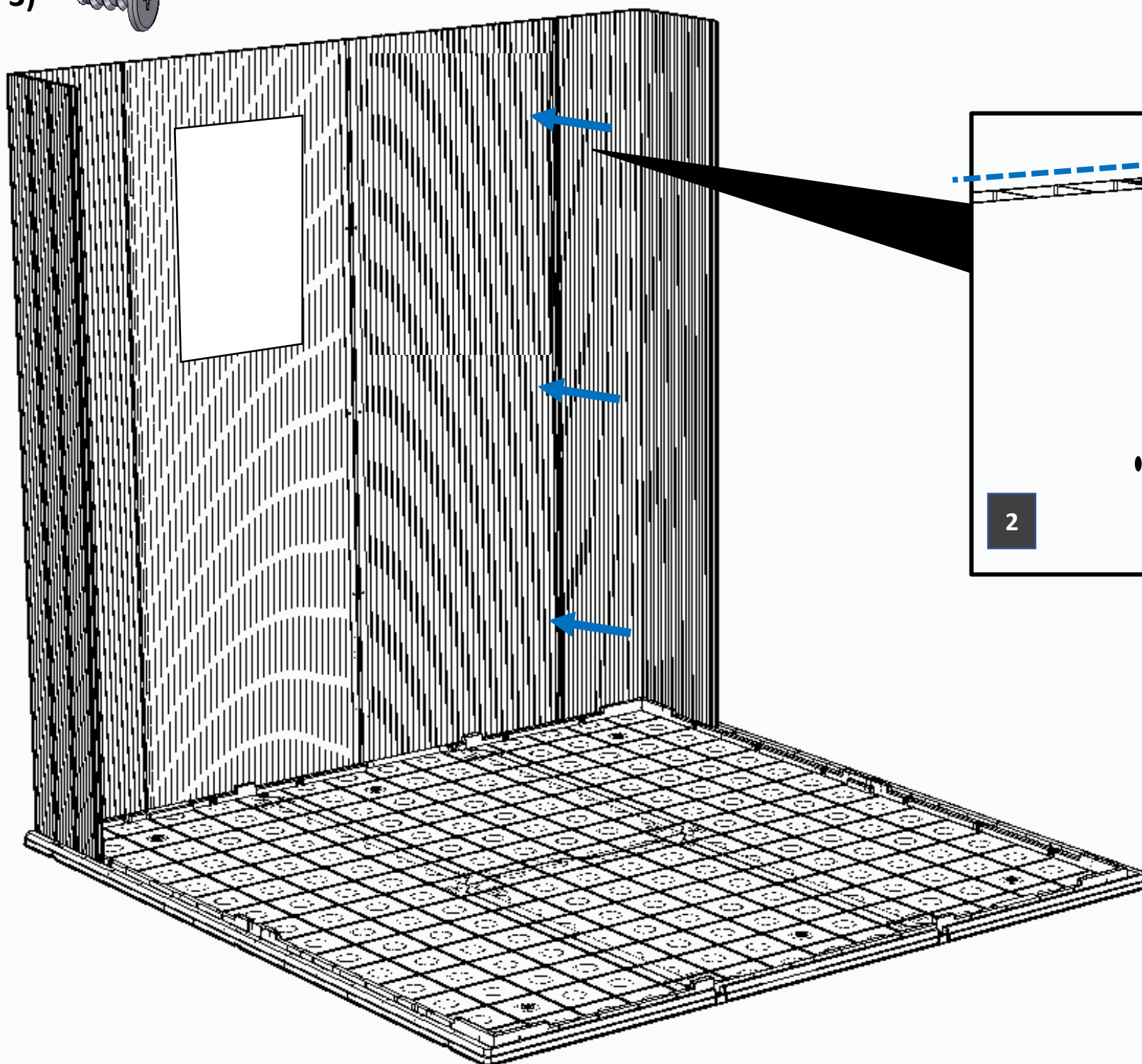
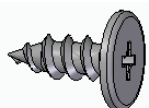

9

DRPS (X1)

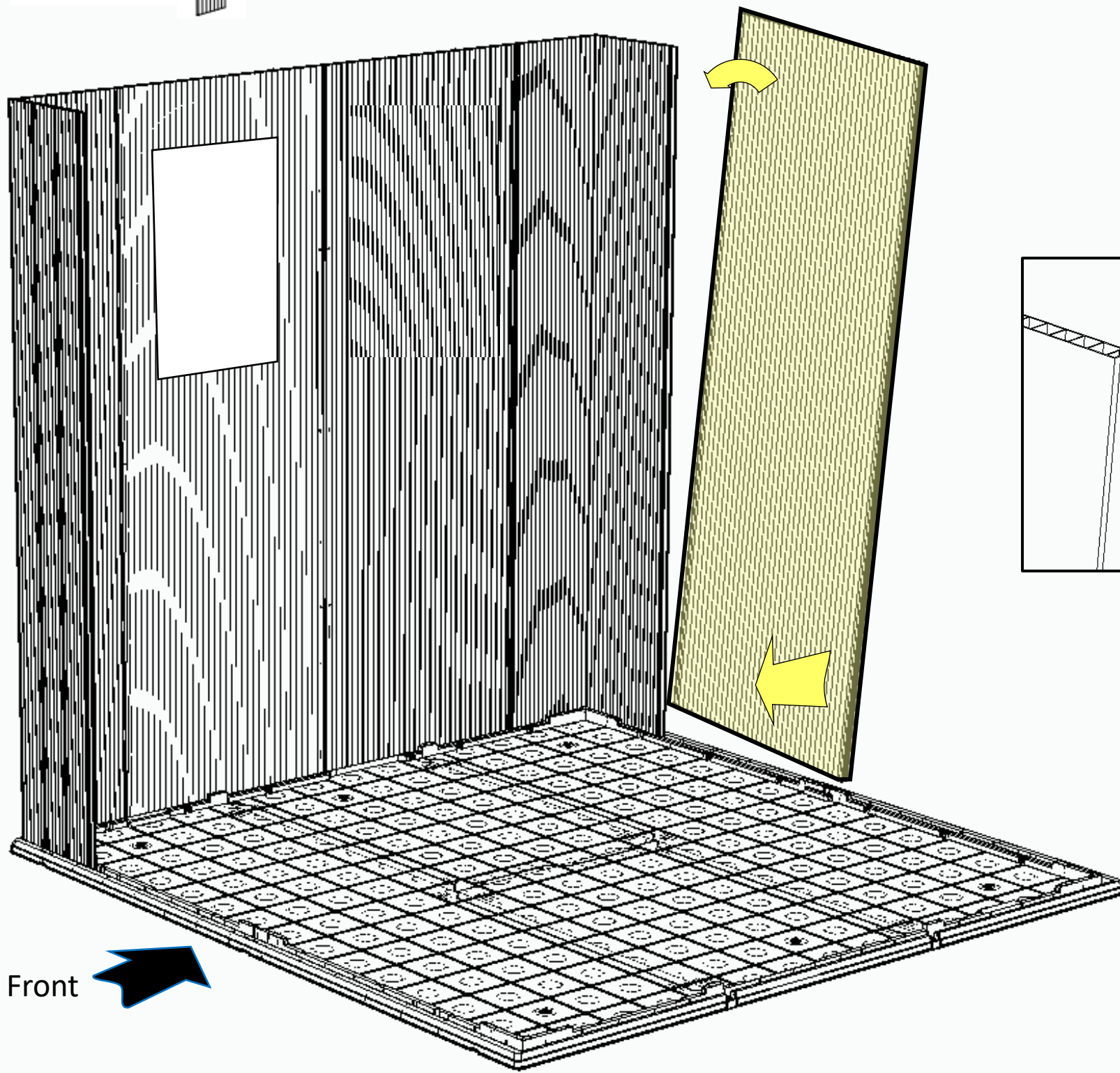

Front

Sc12t (x 3)

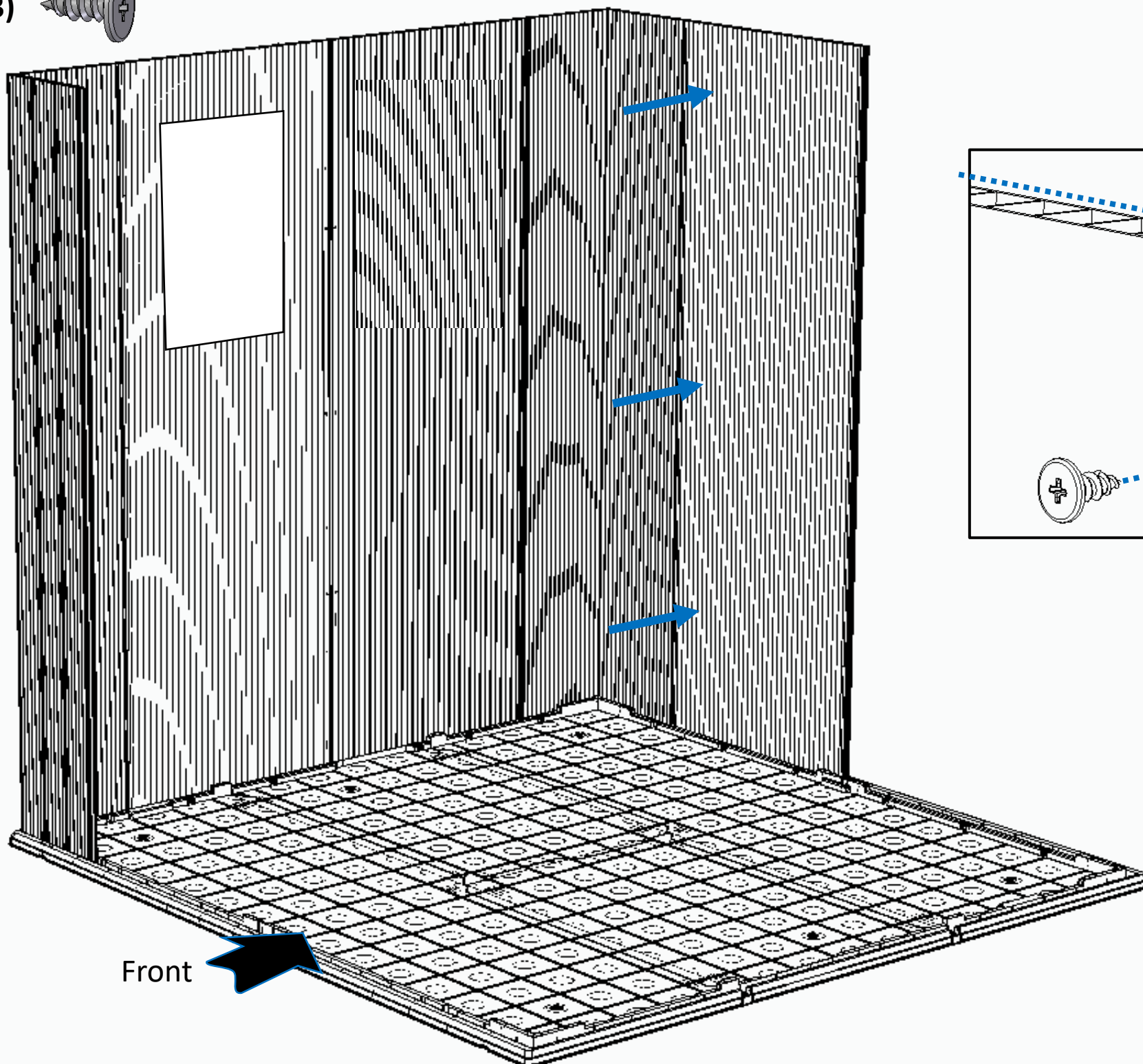
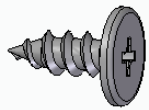

Front

10

DRMDD (x1)

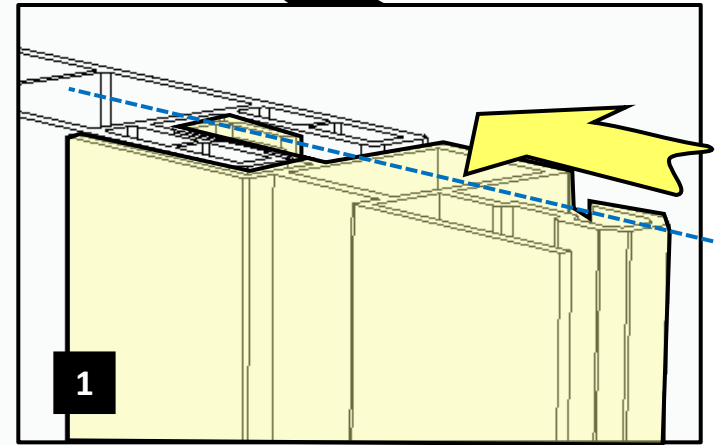
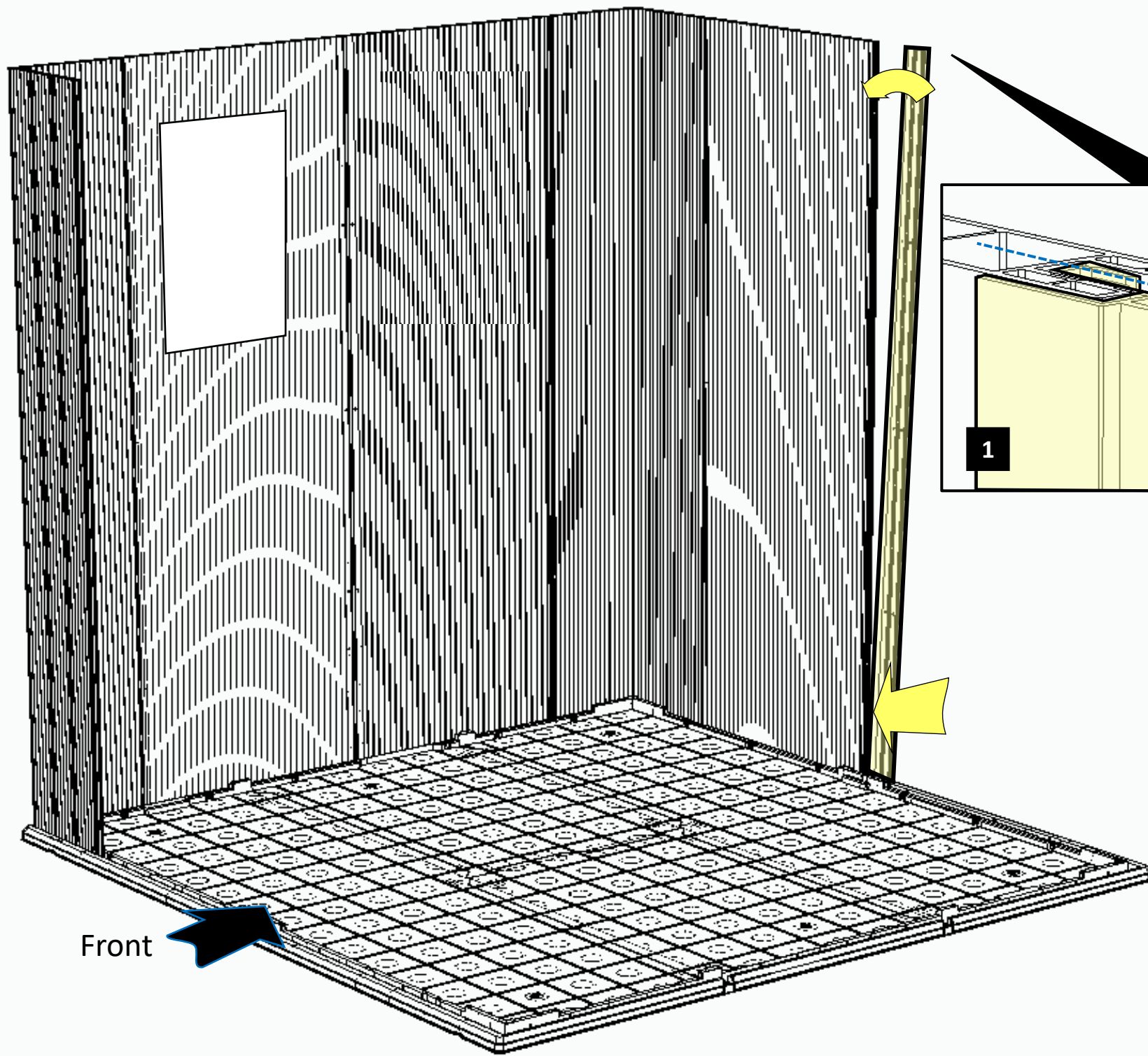
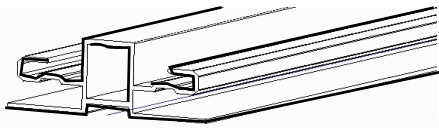

Sc7t (x3)

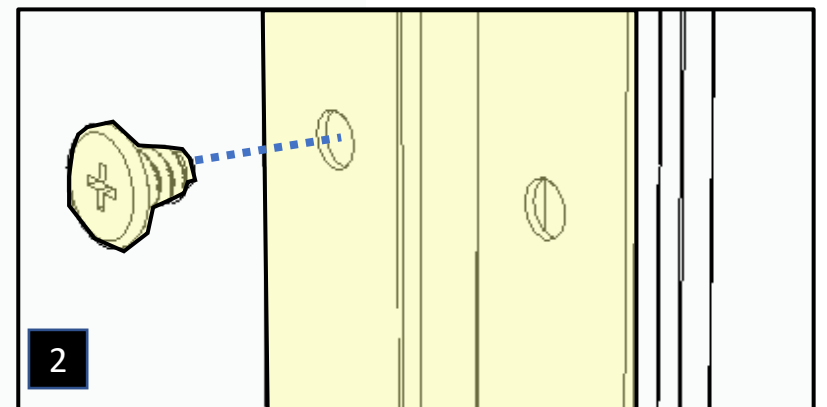
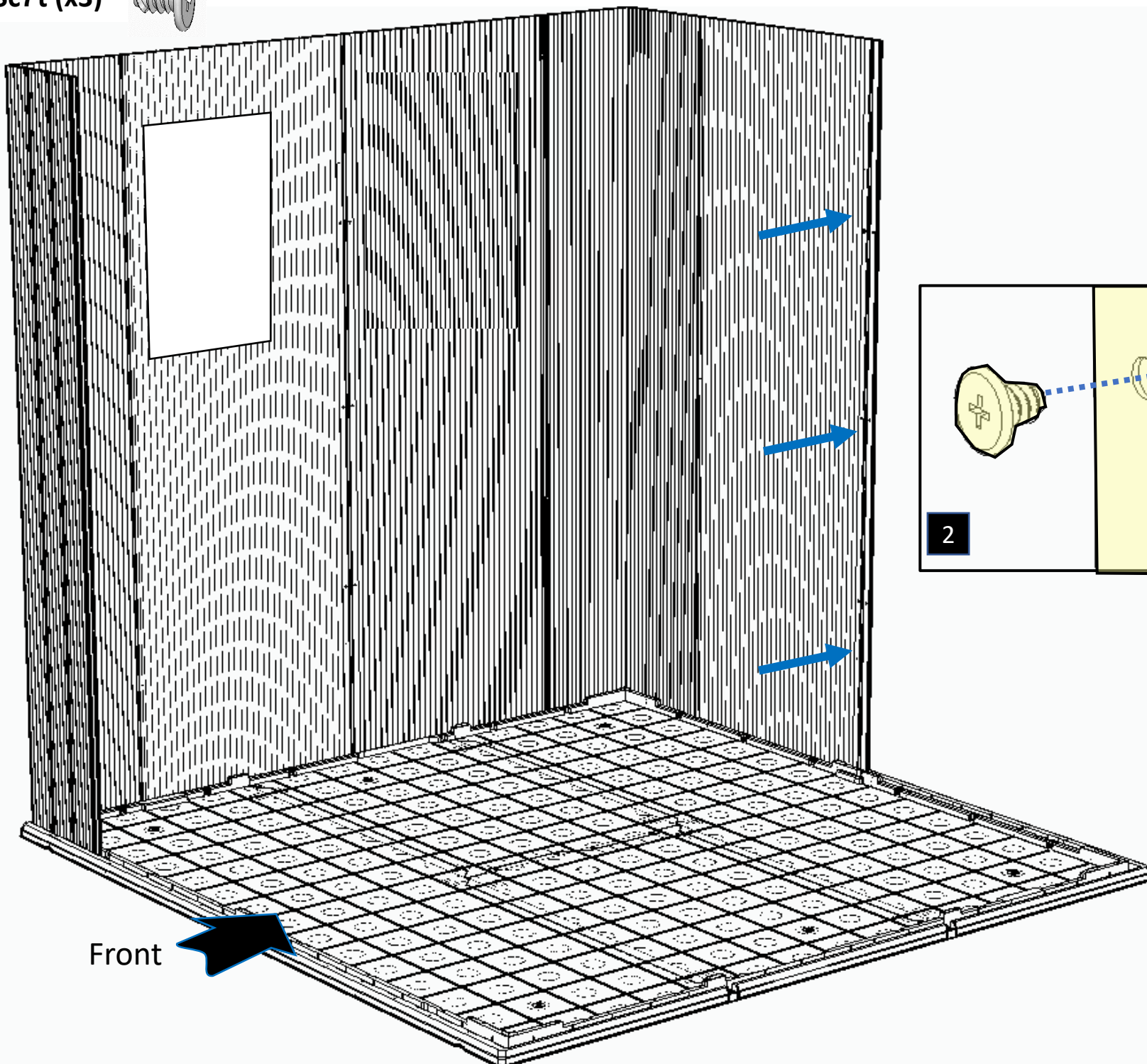

11

DRPS (X1)

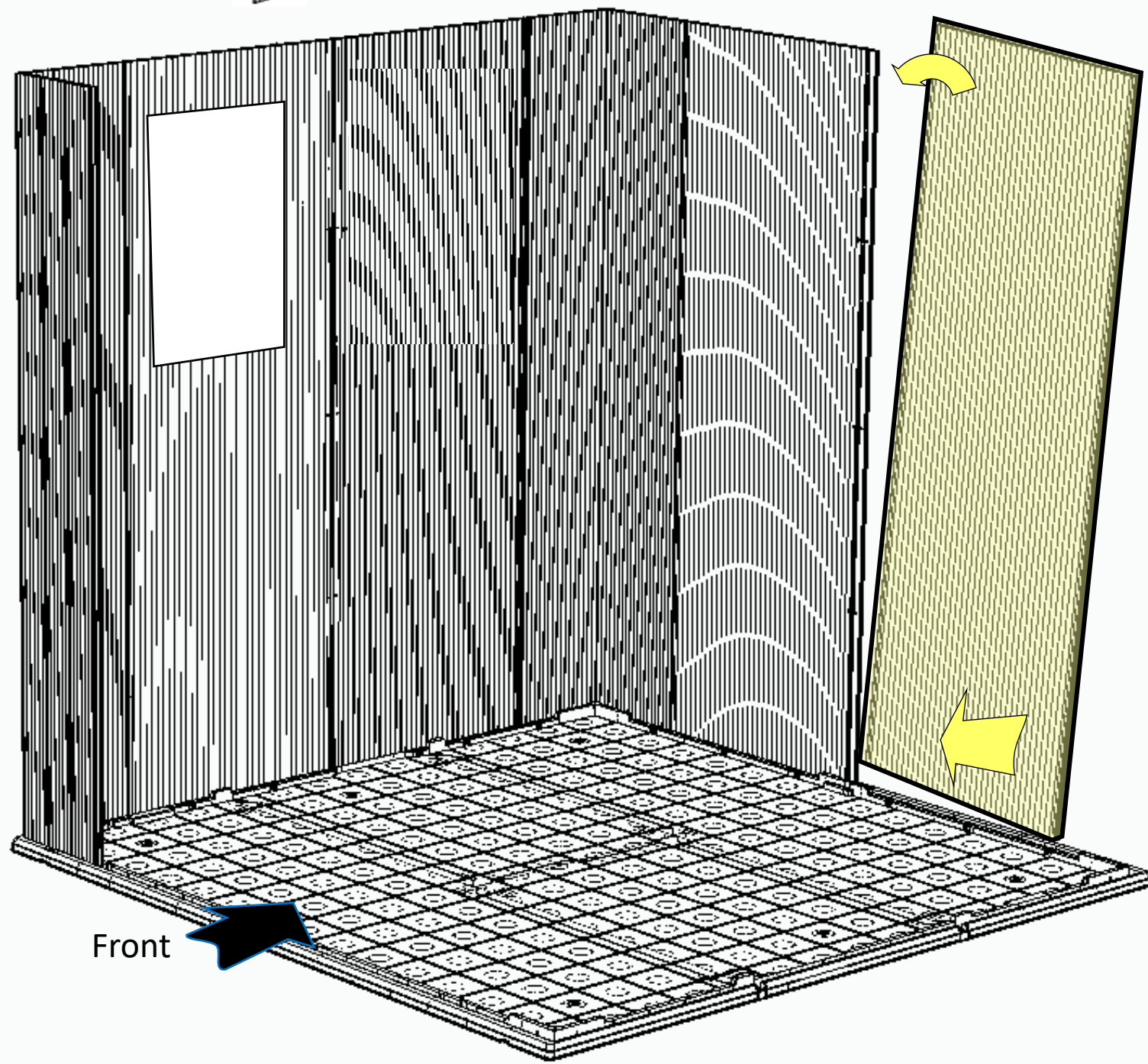
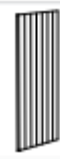

Sc7t (x3)

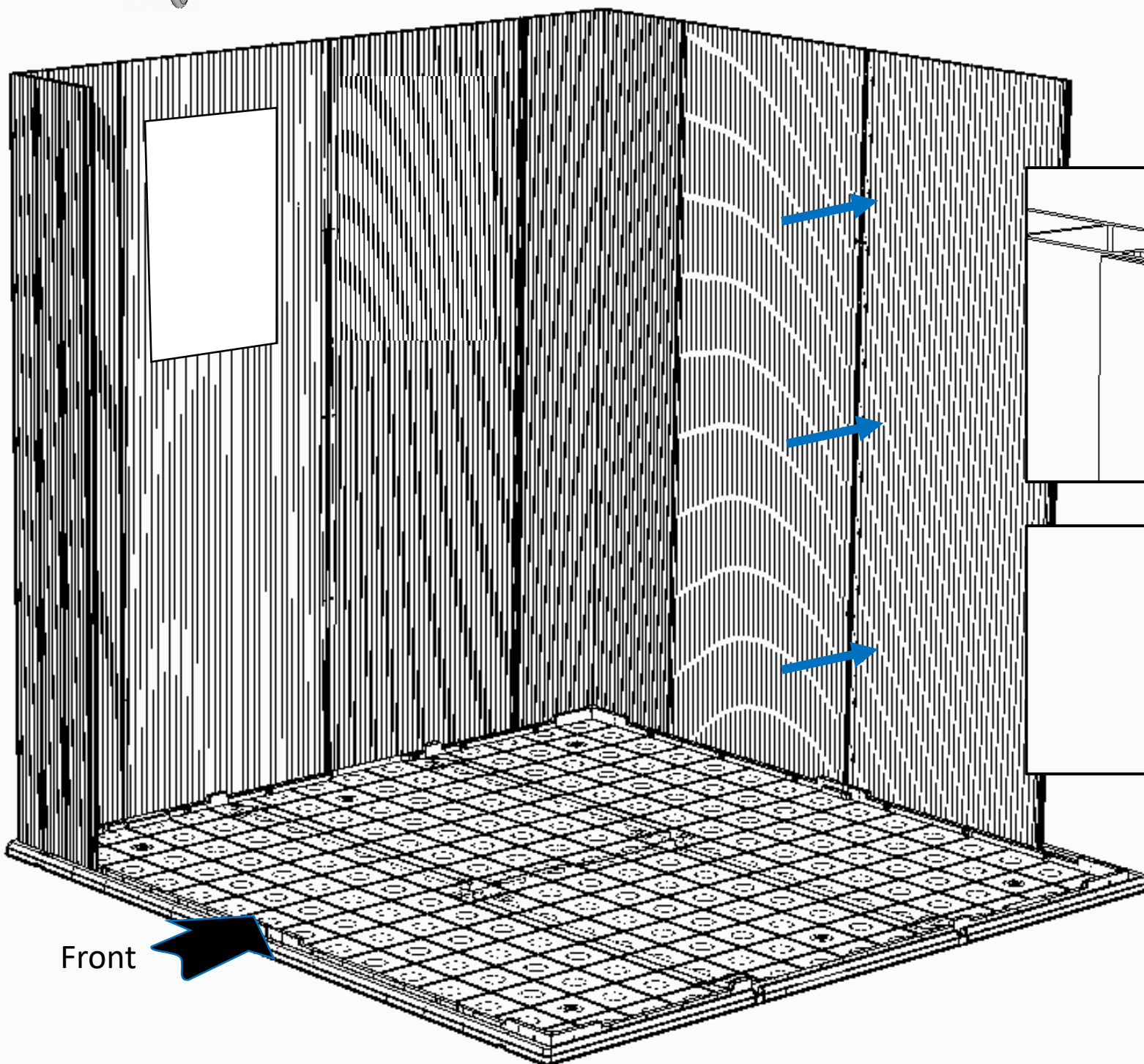
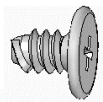

12

DRCP x 1

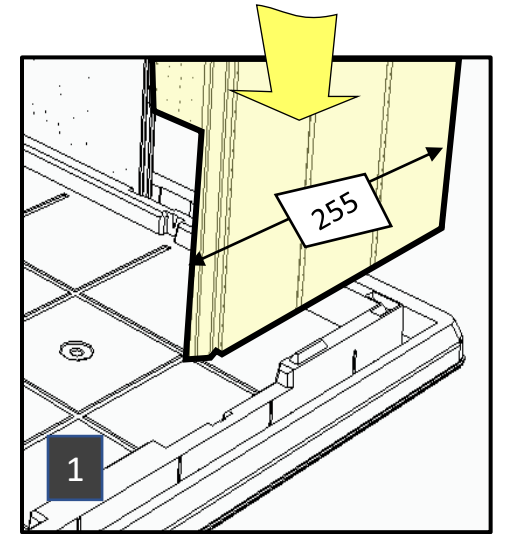
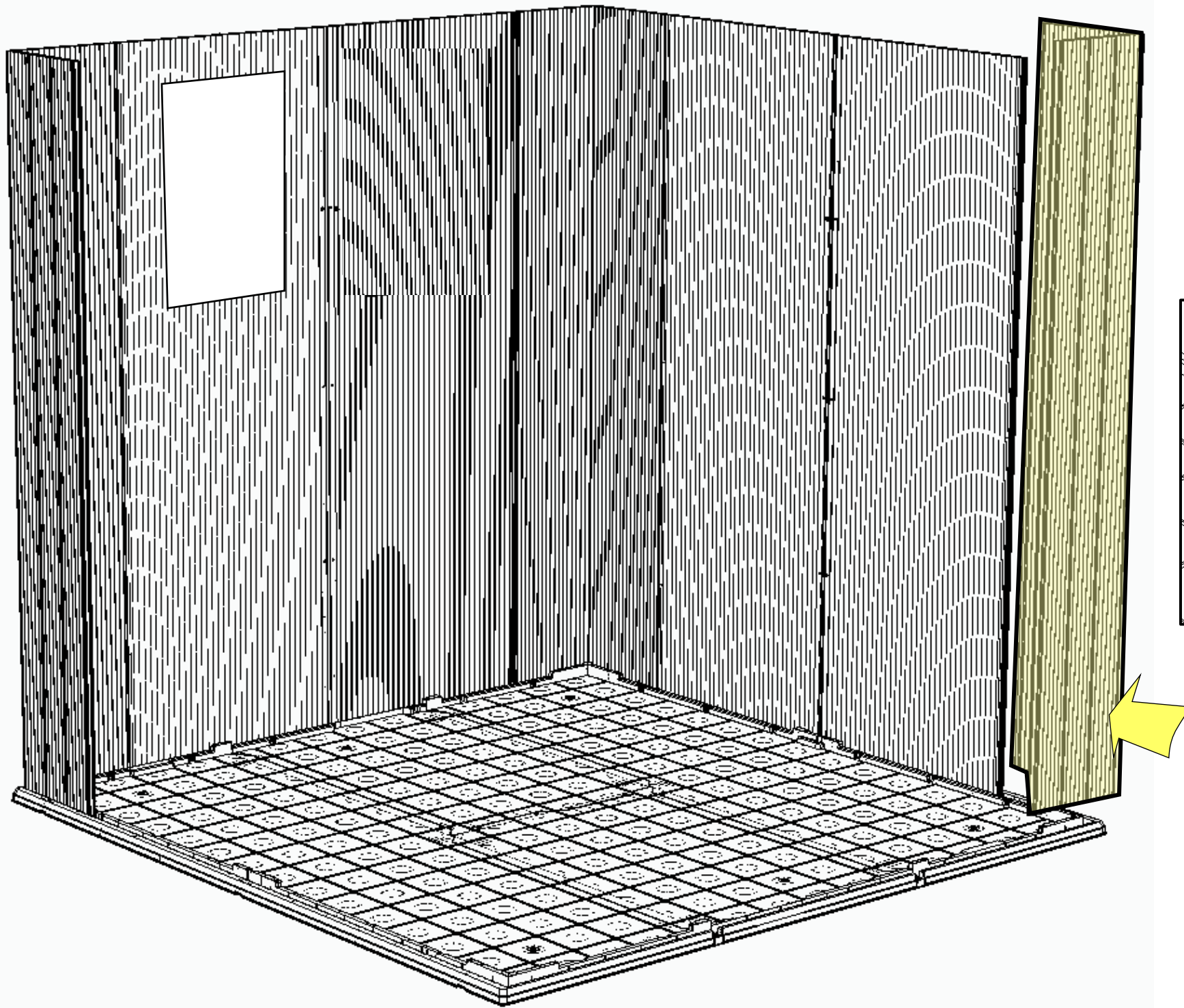

Sc12t (x 3)

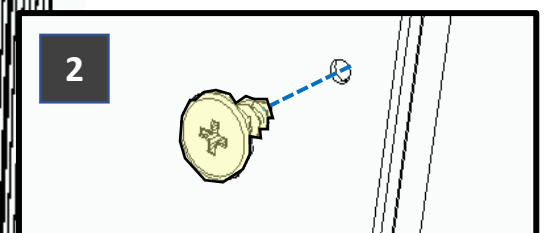
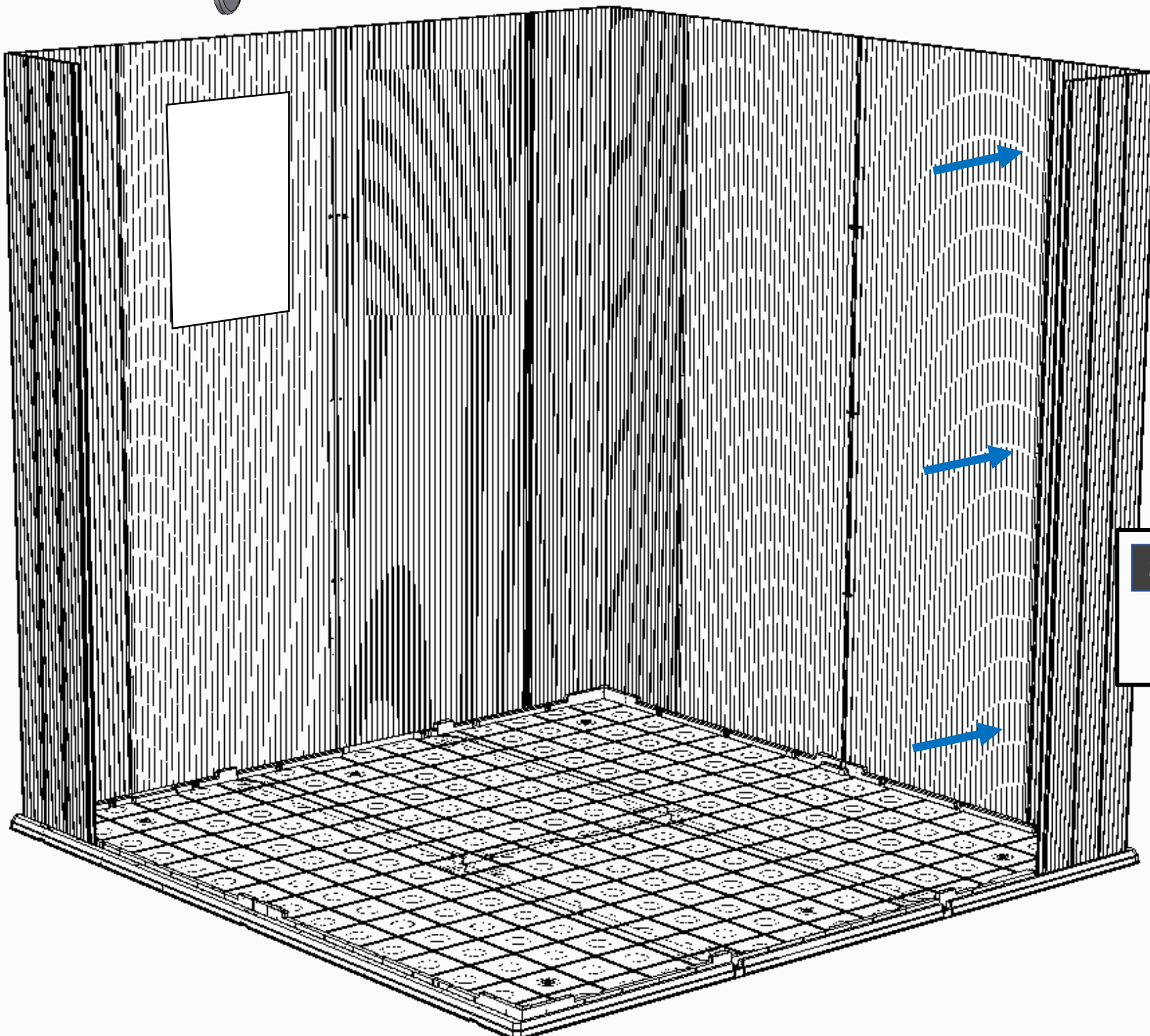
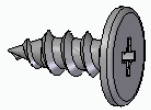

13

DRPS (X1)

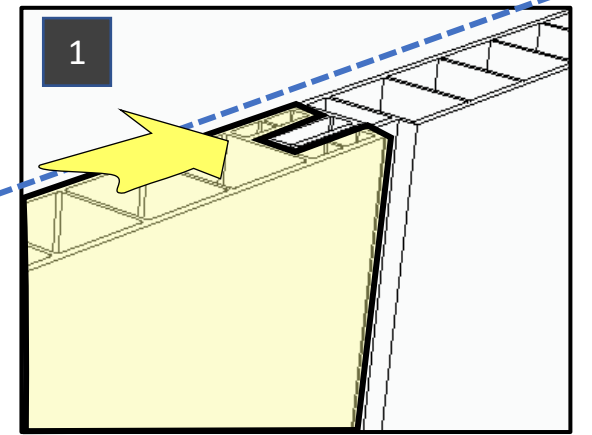
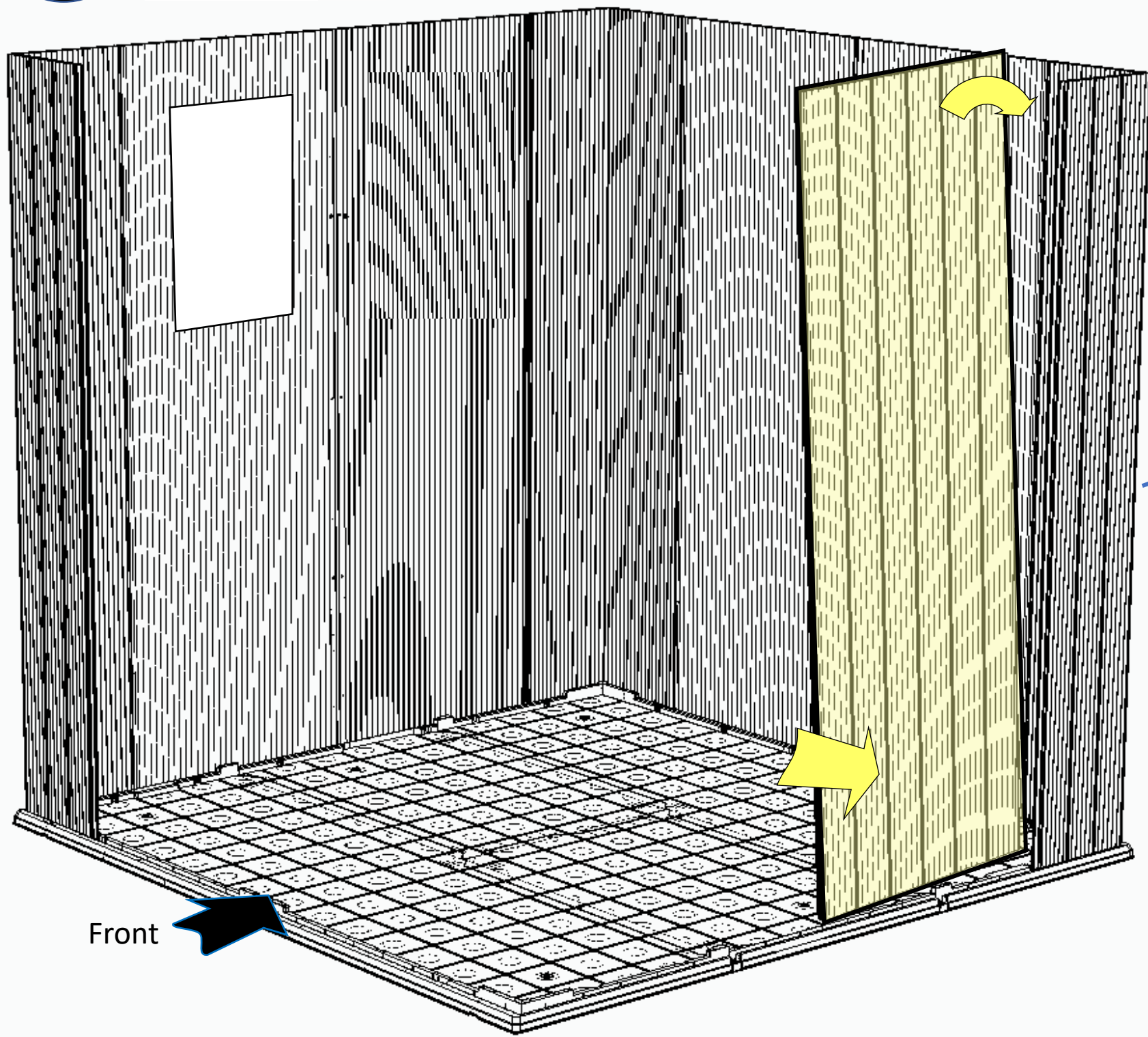
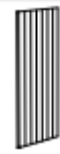

Sc12t (x 3)

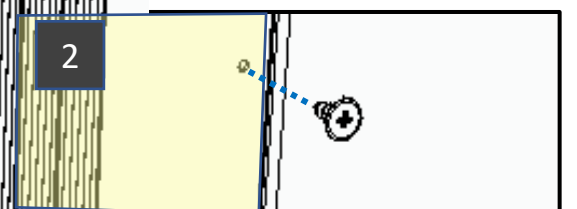
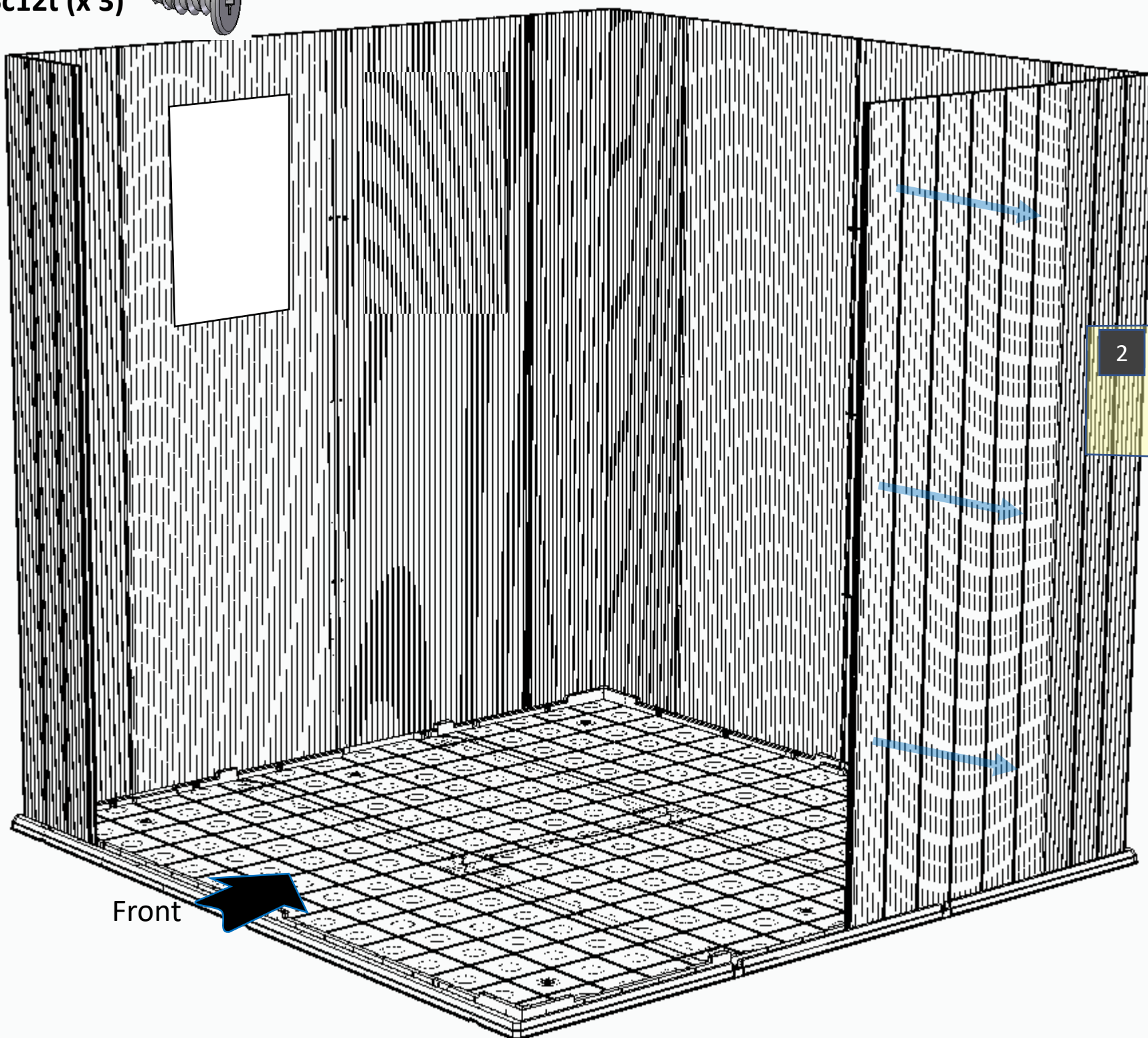
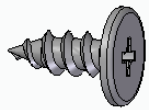

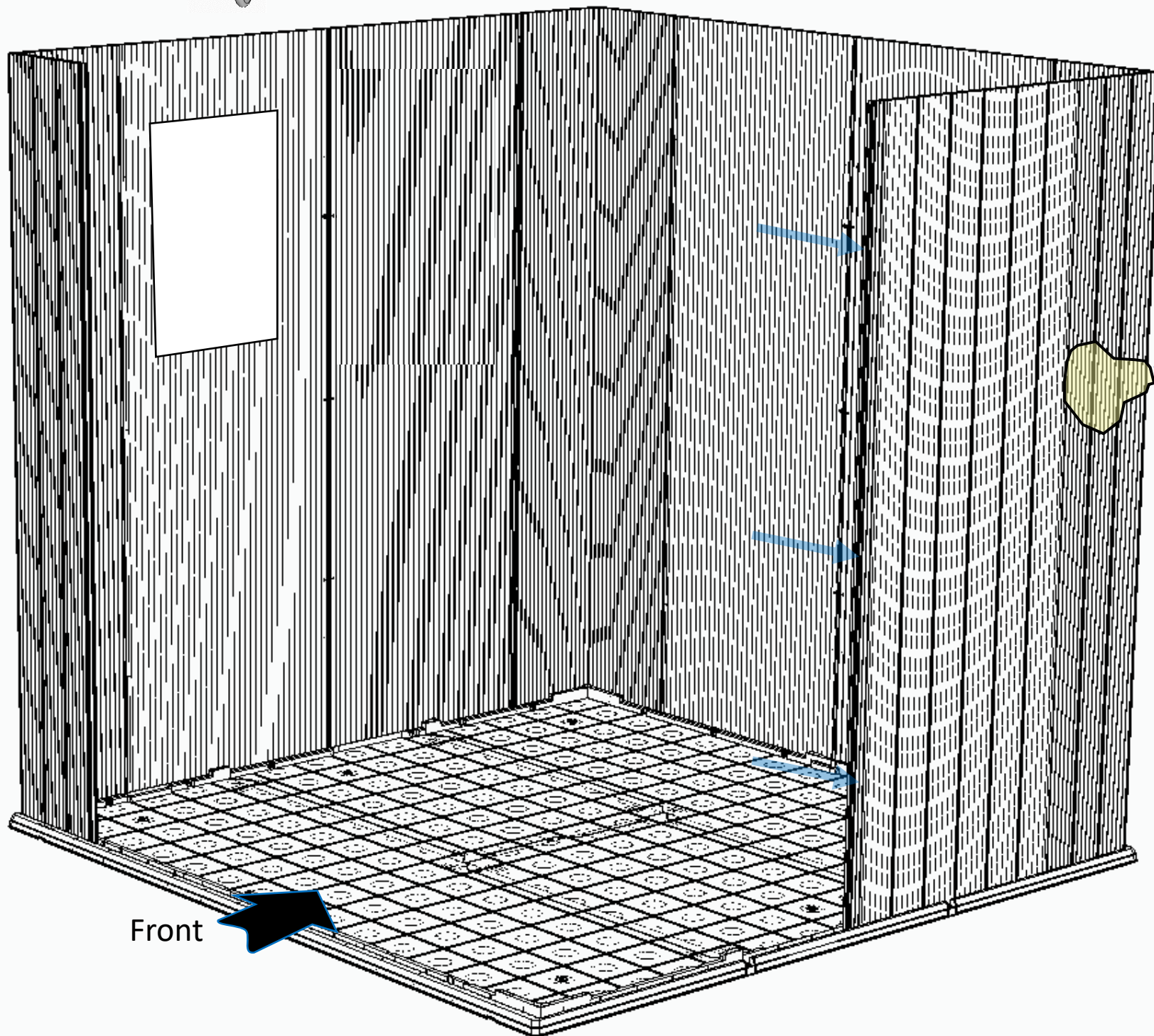
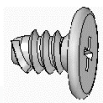
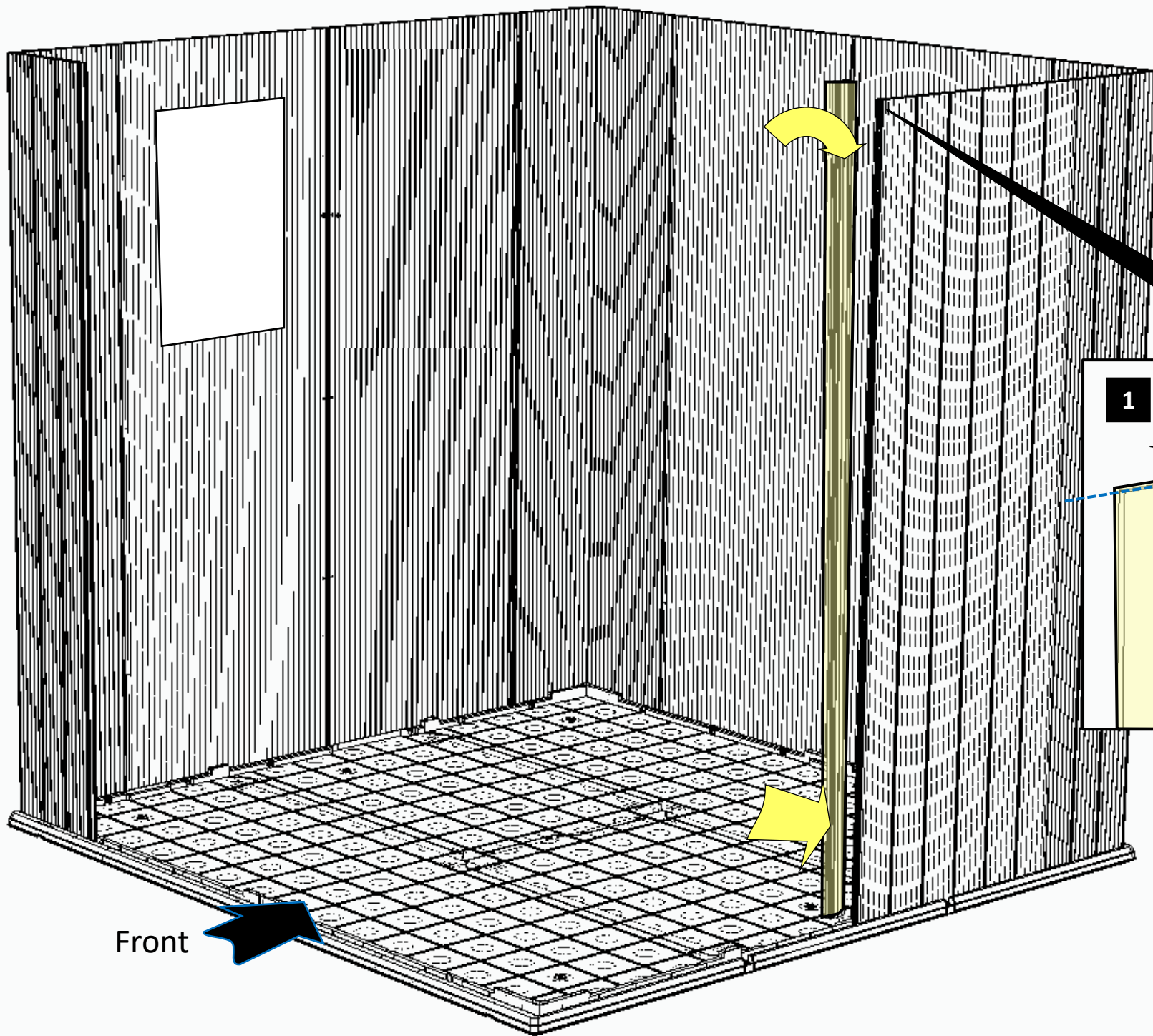
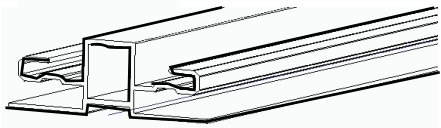

15

DRPS (X1)

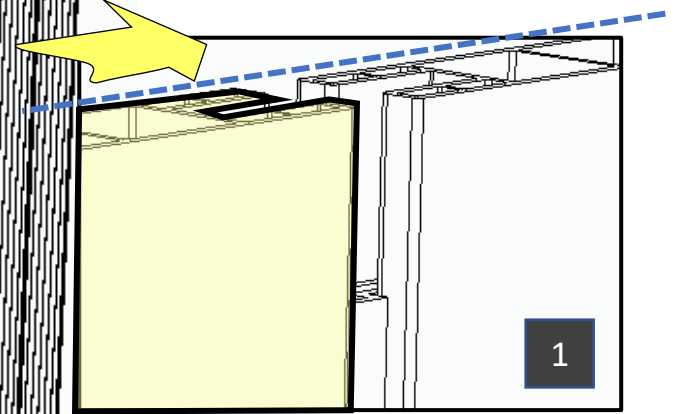
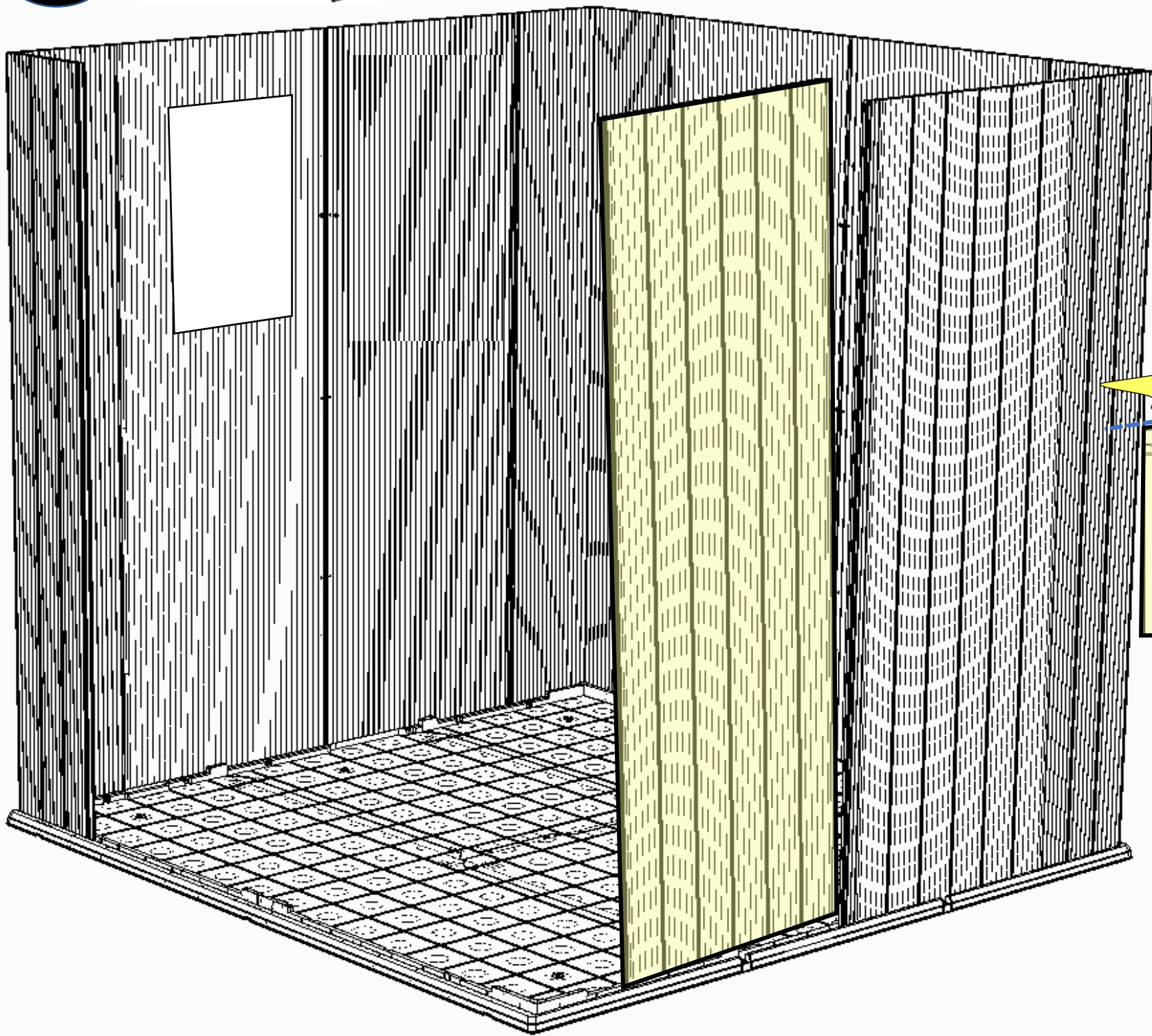
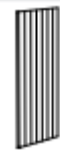

Sc7t (x3)

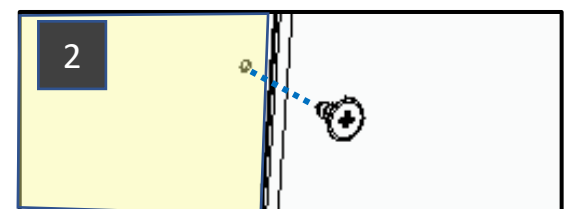
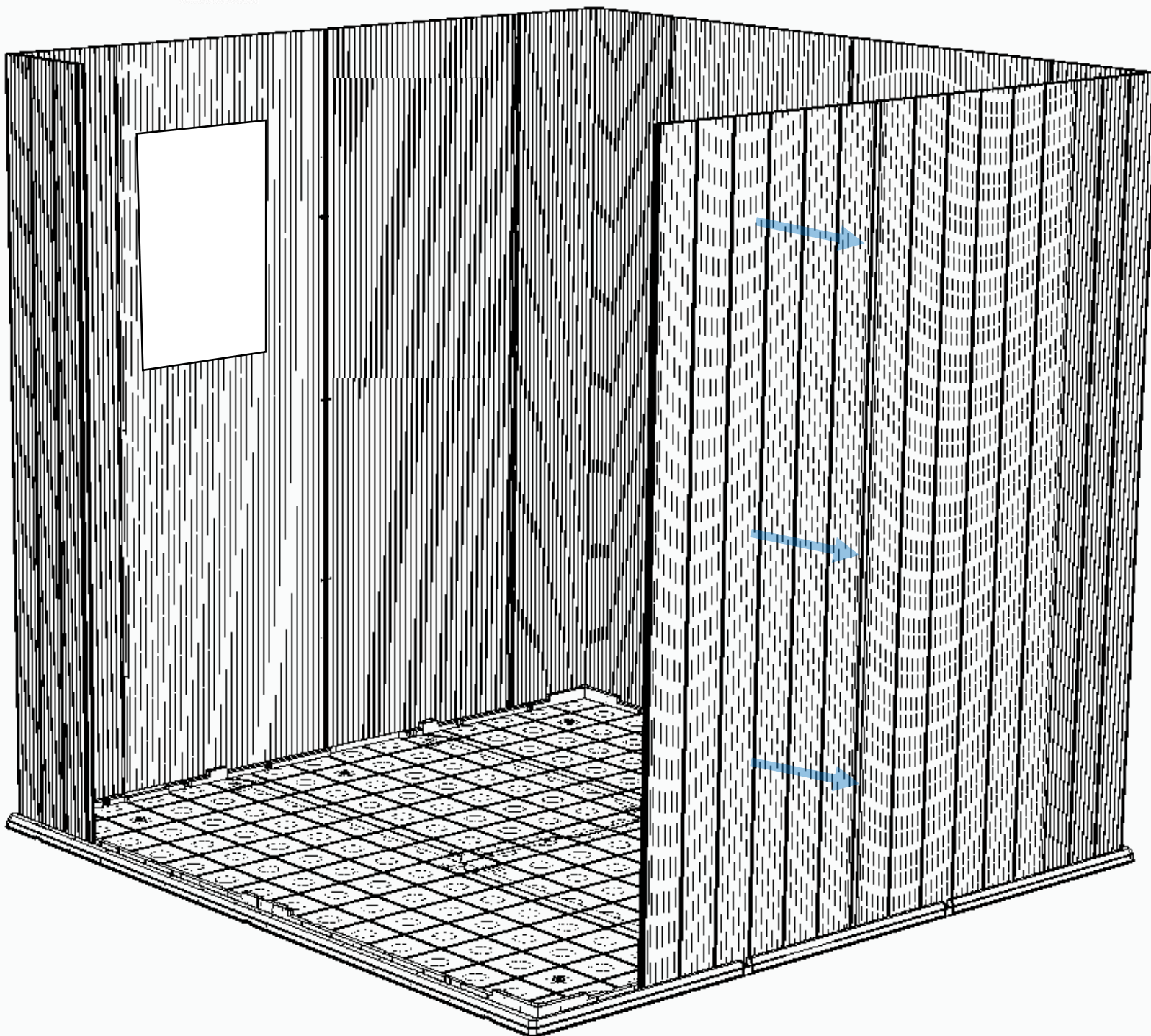

16

DRCP x 1

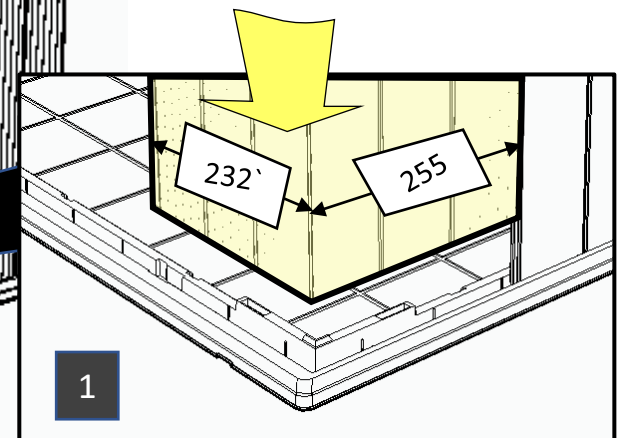
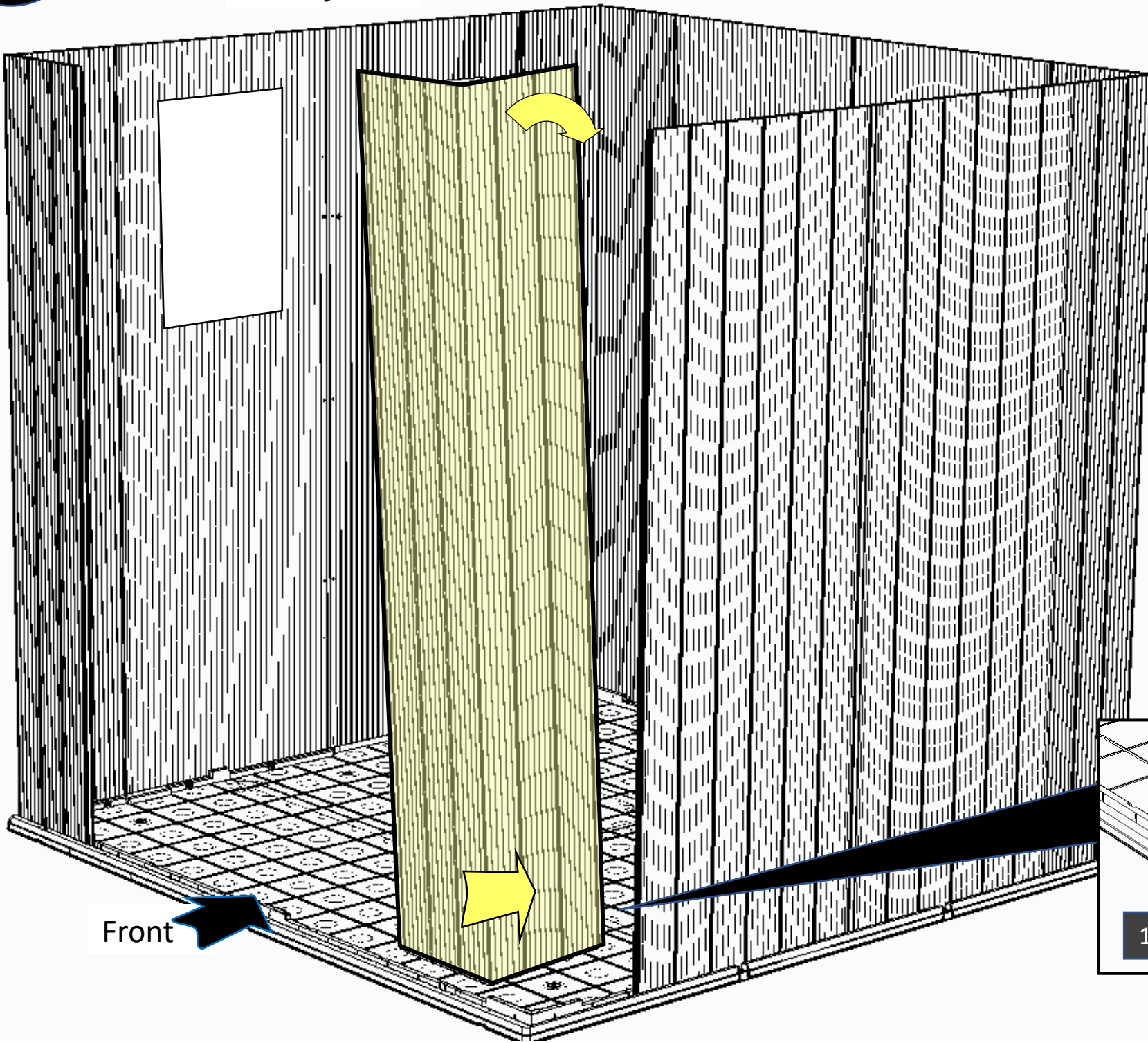

Sc12t (x 3)

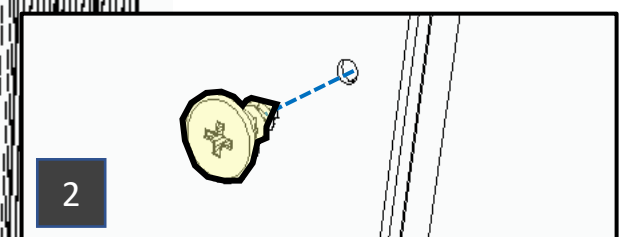
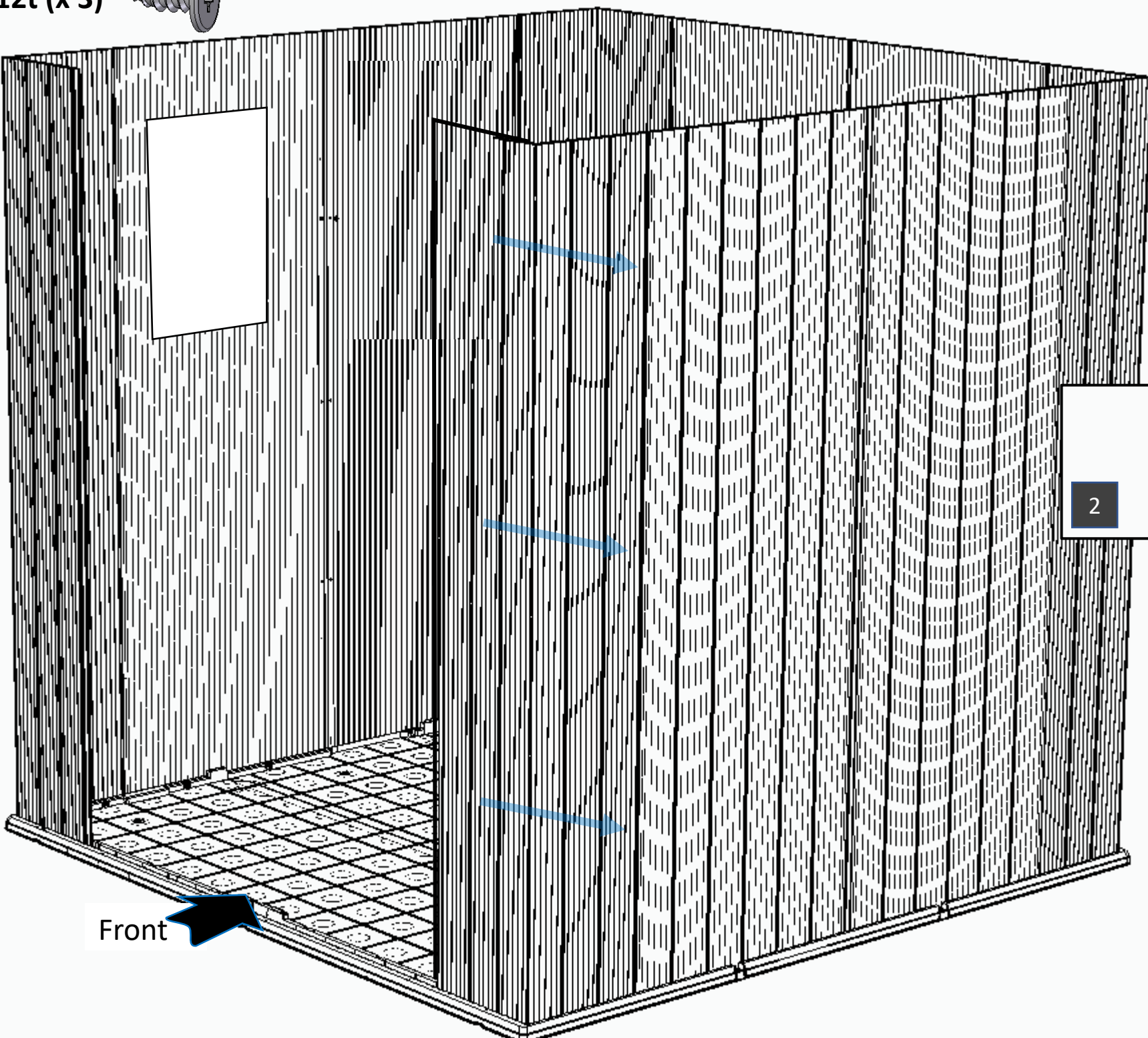
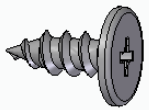

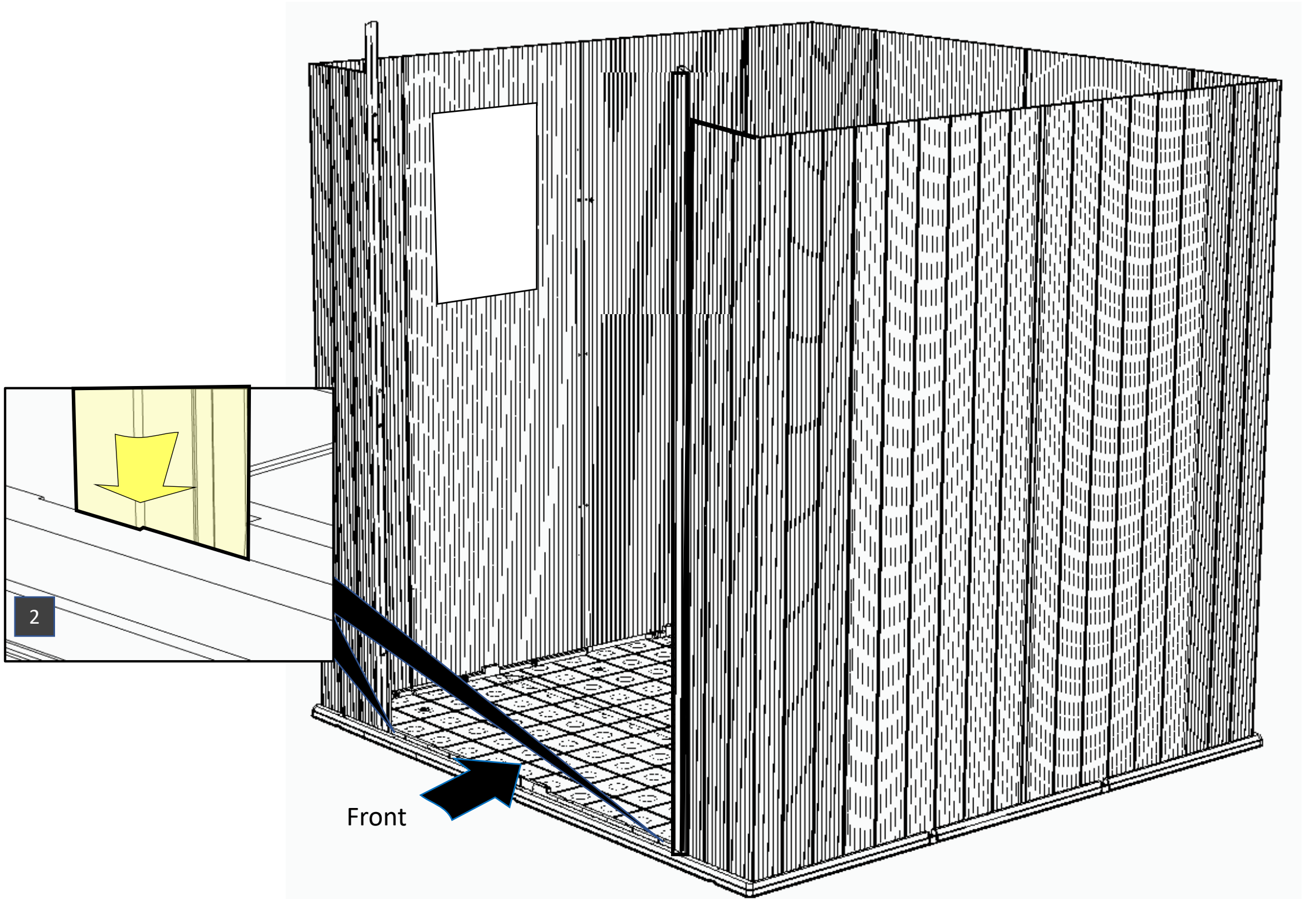
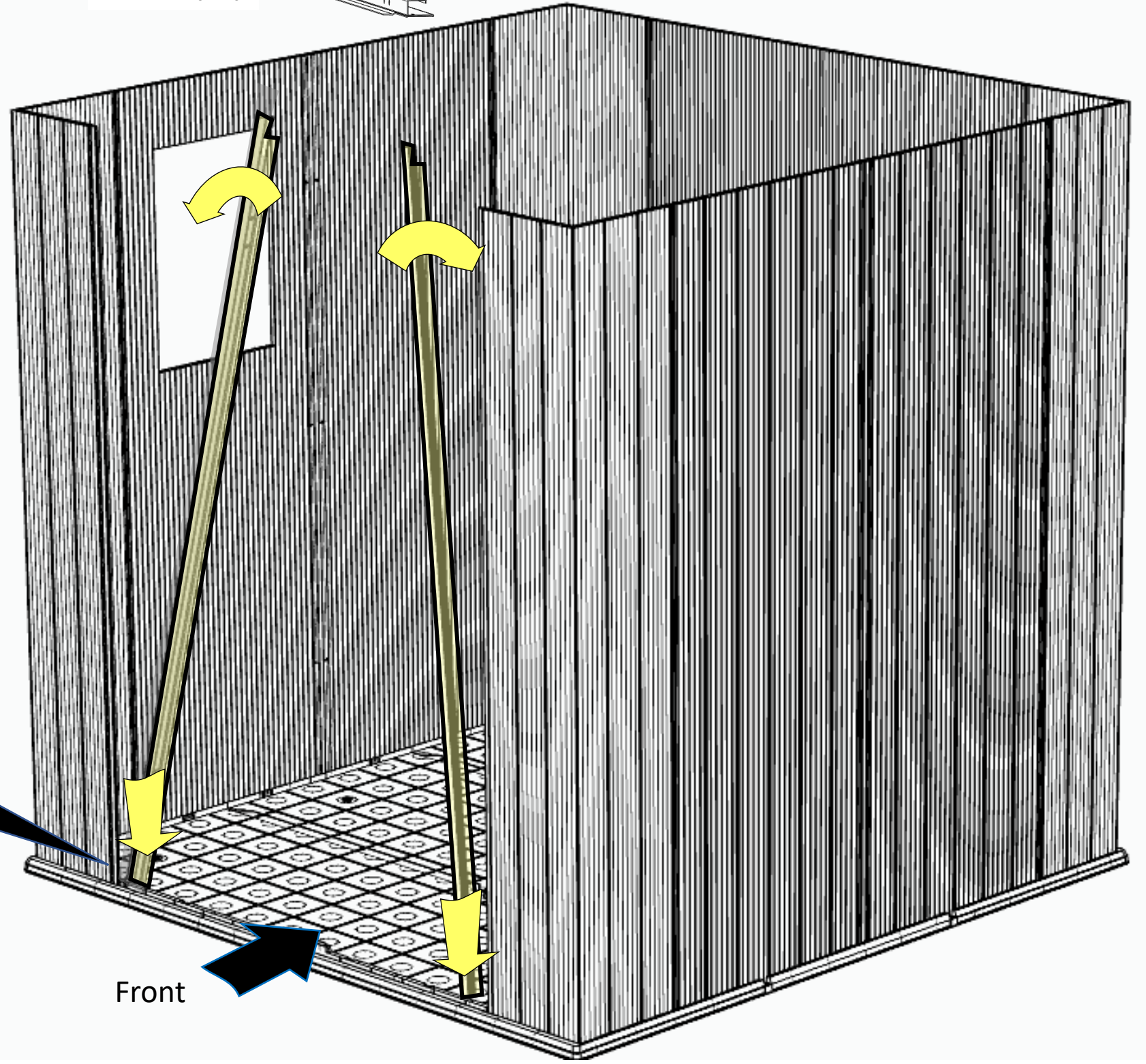
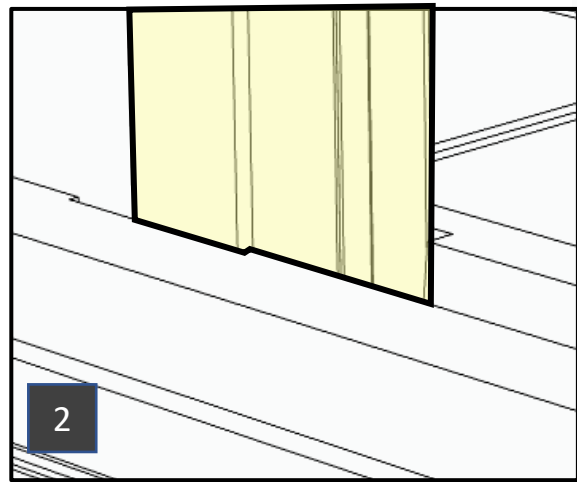
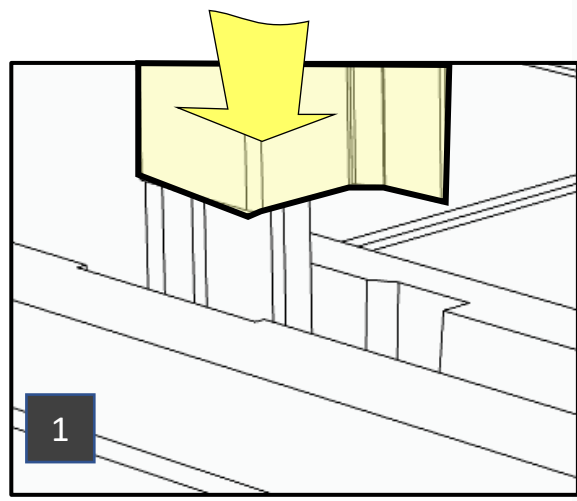
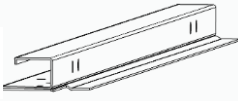

Roof assembly

DRLFG (x1)

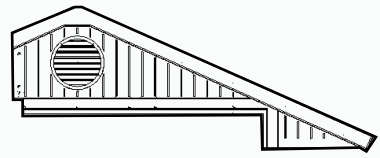

DRSFG (x1)

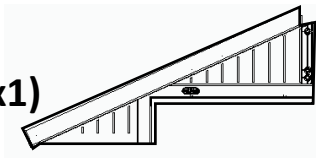

Sc12t (x3)

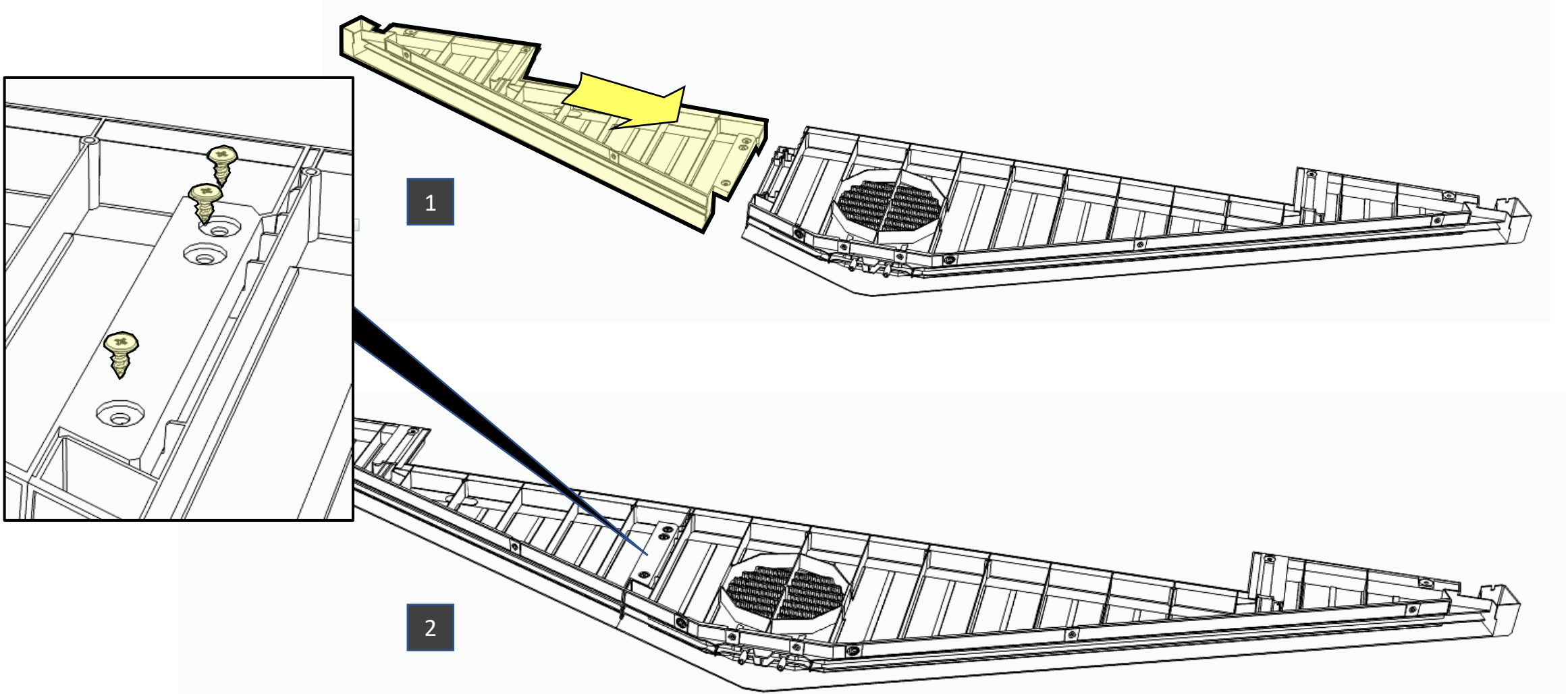
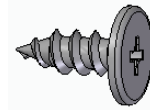

DRLRG (x1)

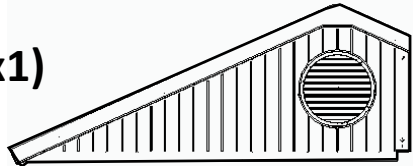

DRSRG (x1)

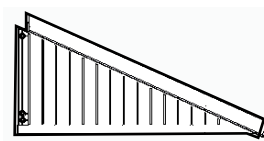

Sc12t (x3)

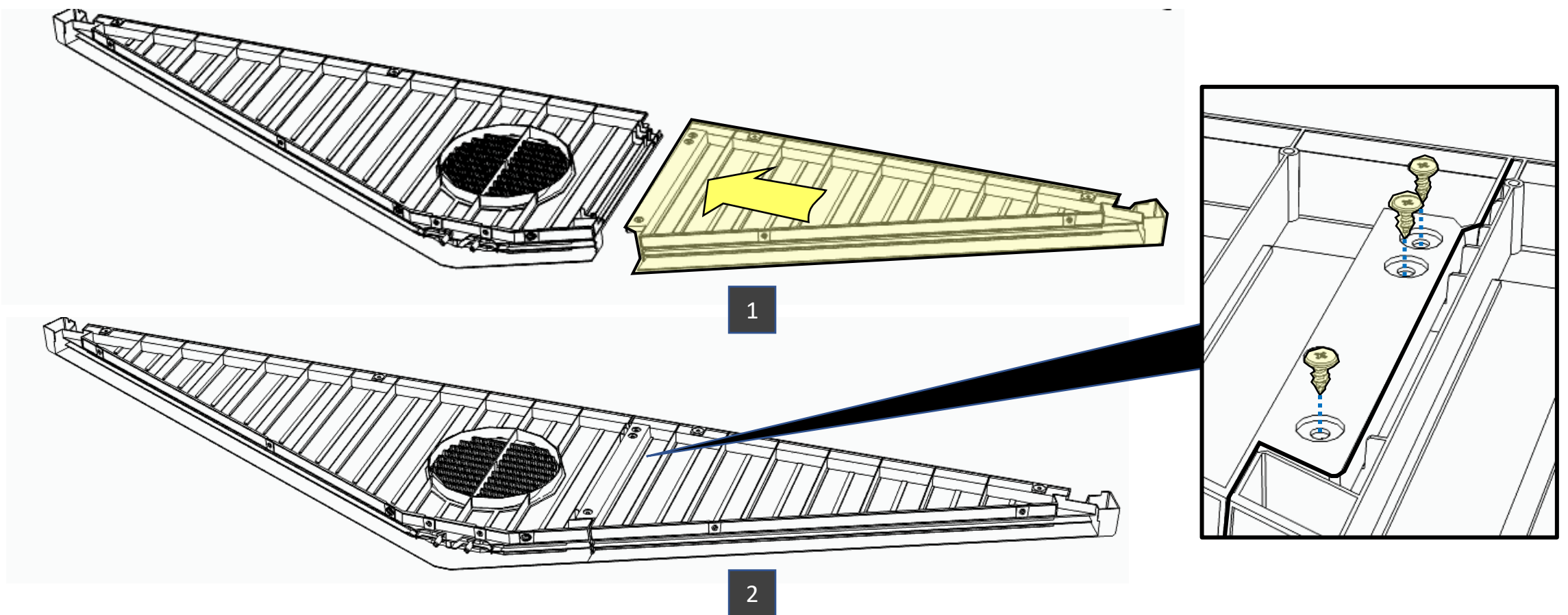
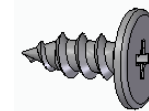

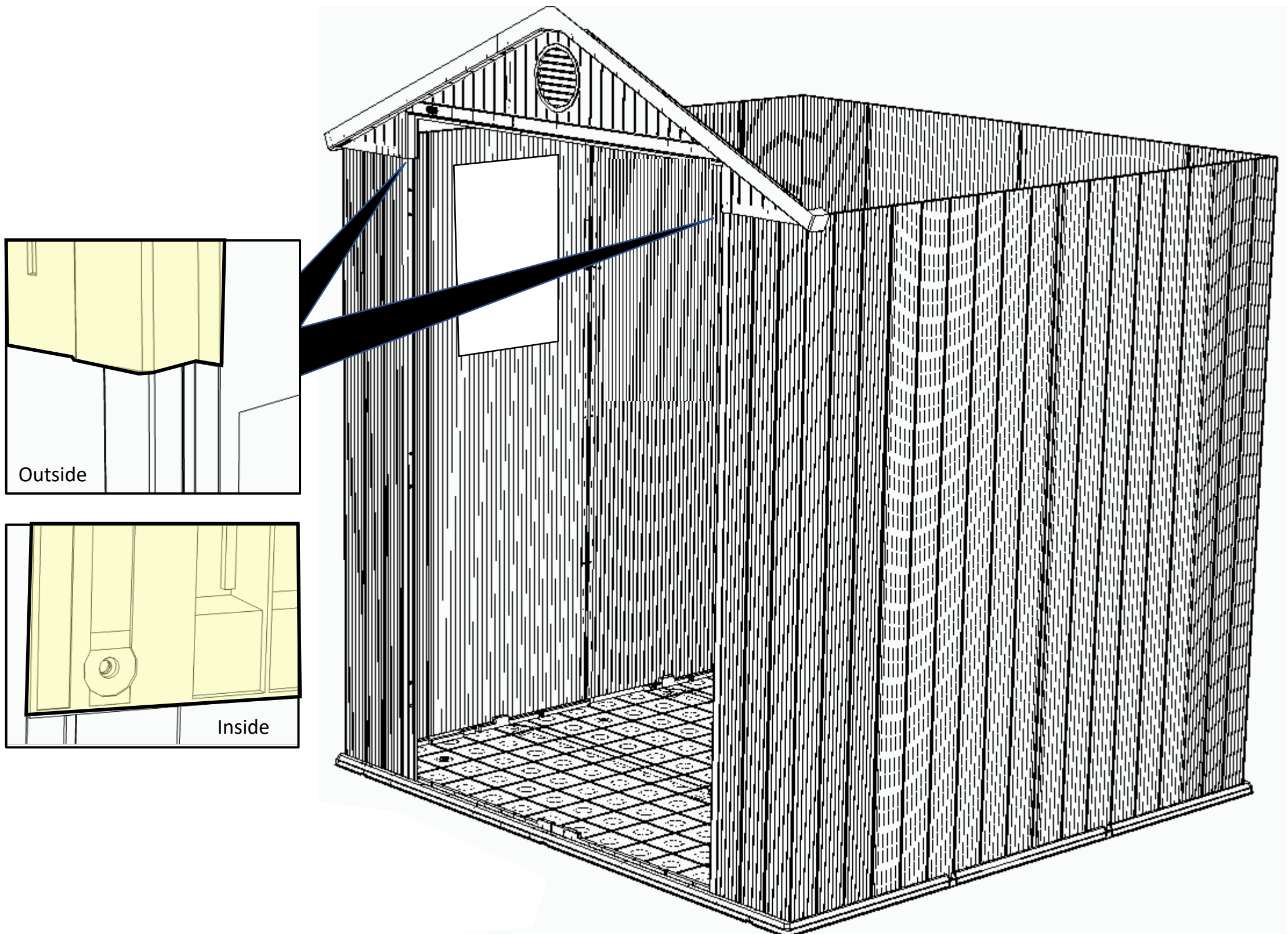
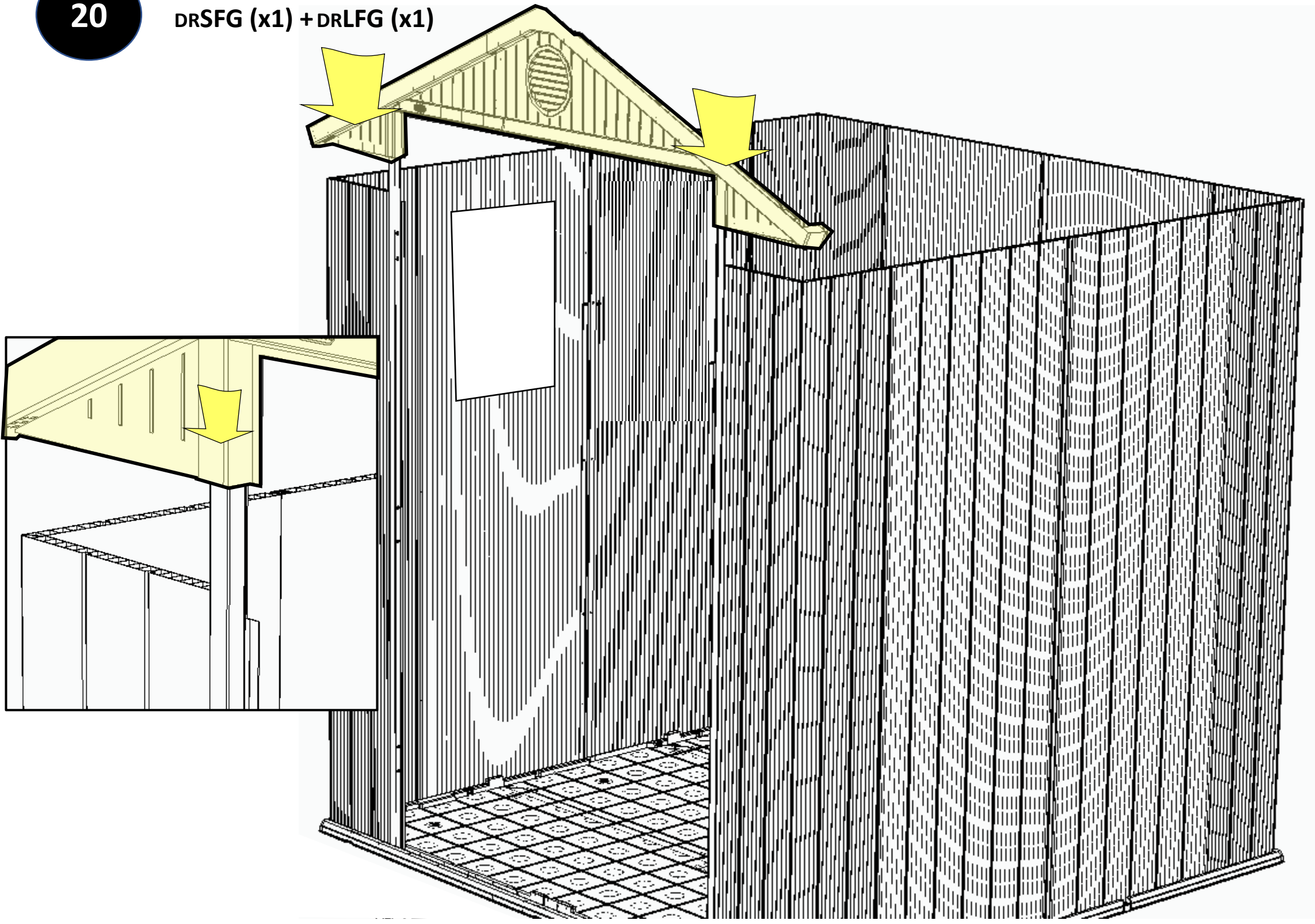

21

DRMTF (x1)

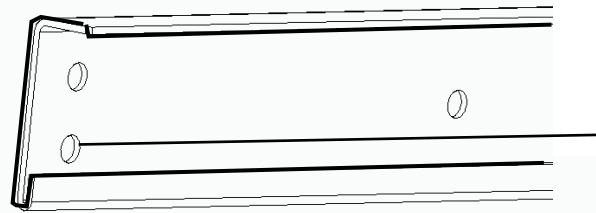

Sc12t (x9)

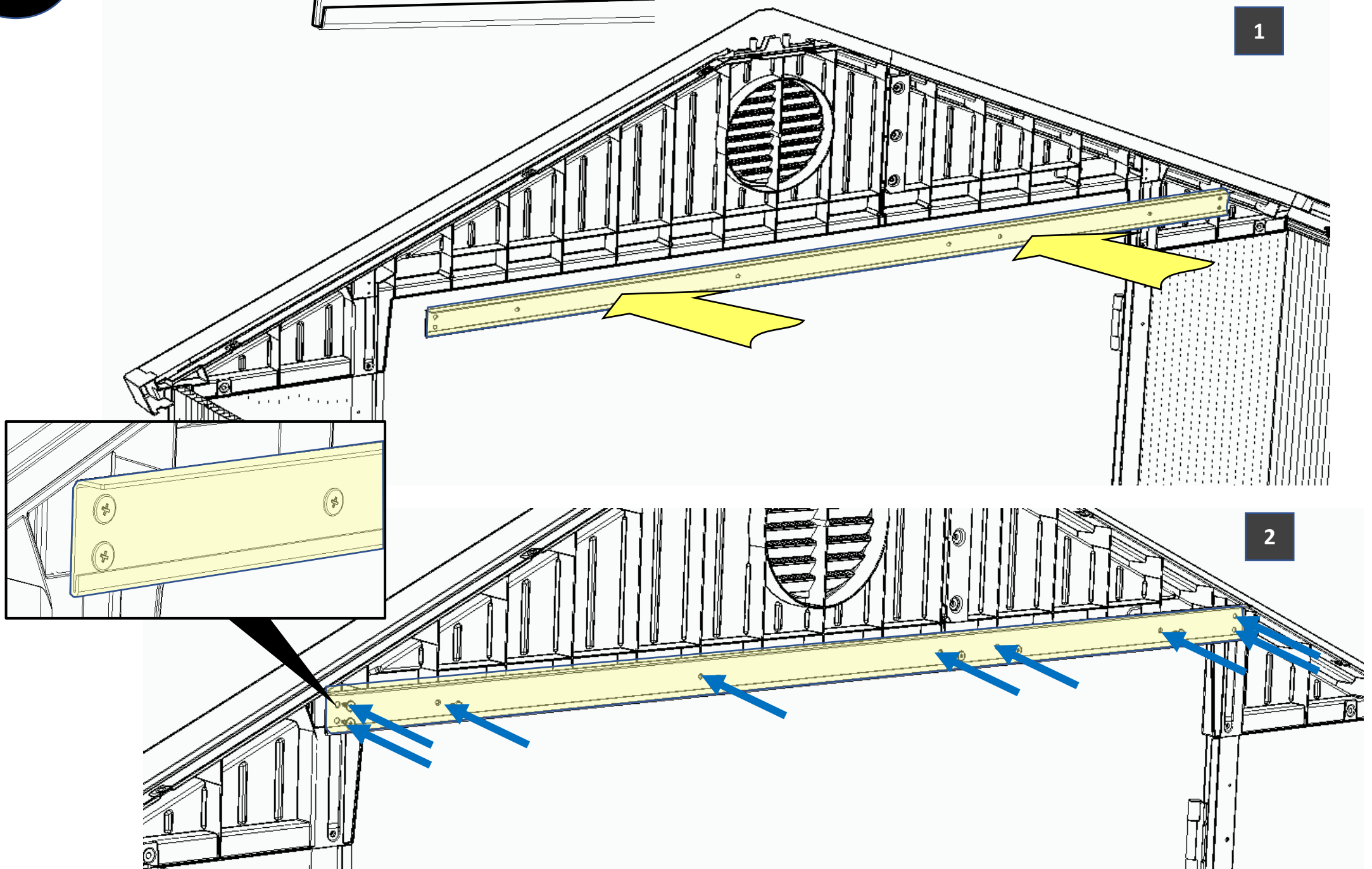
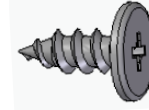

22

Sc12t (x10)

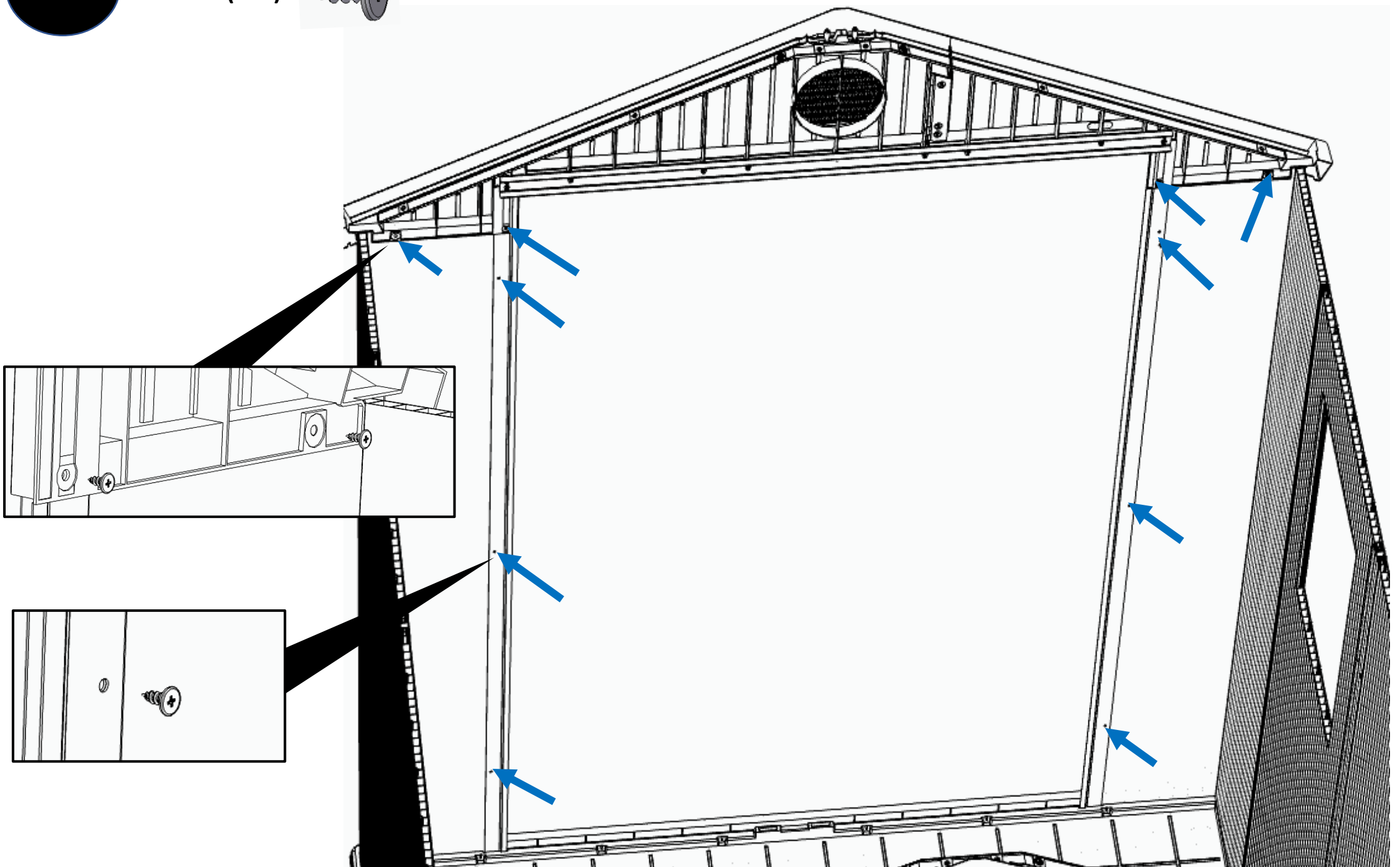
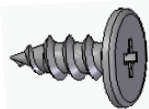

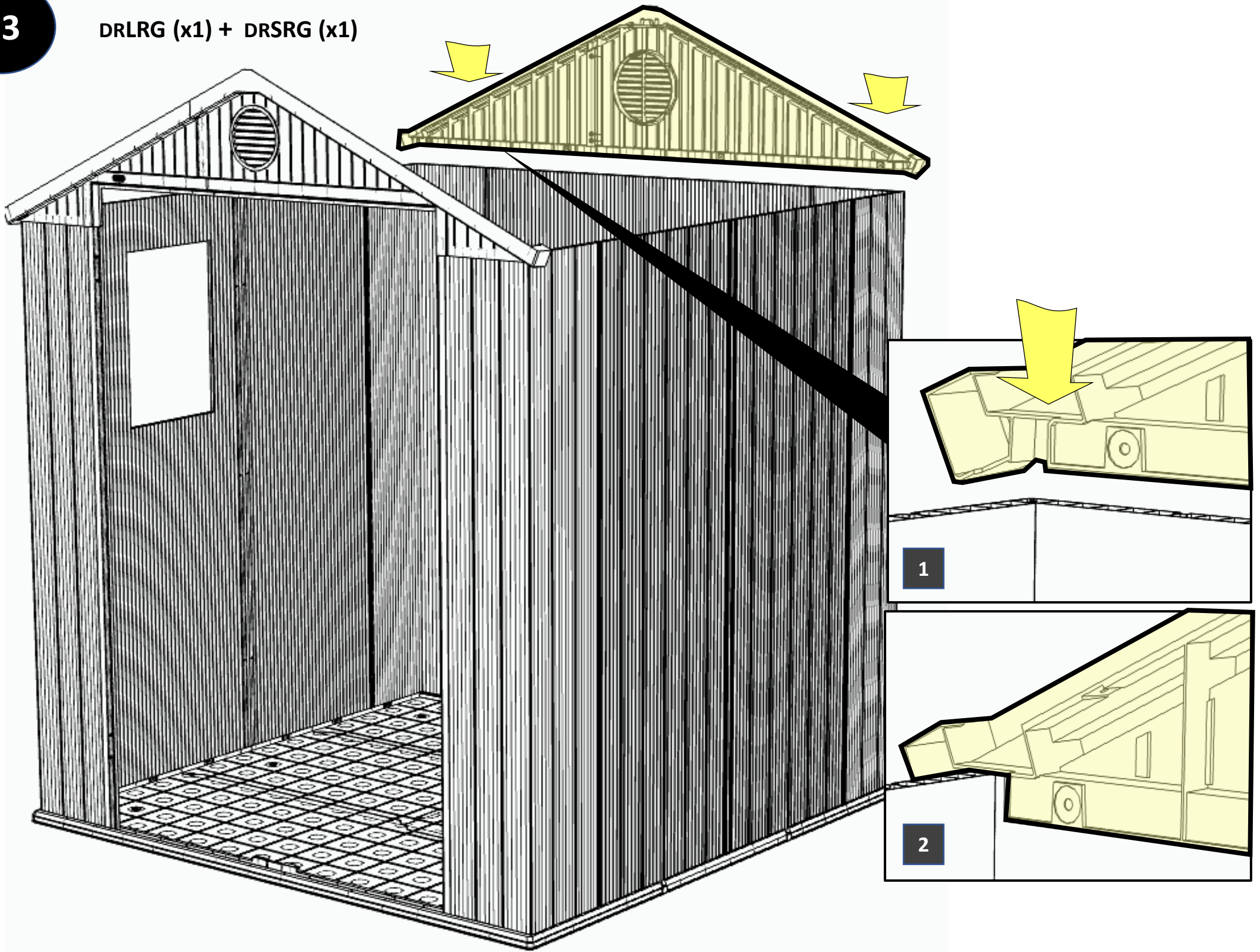

Sc12t (x6)

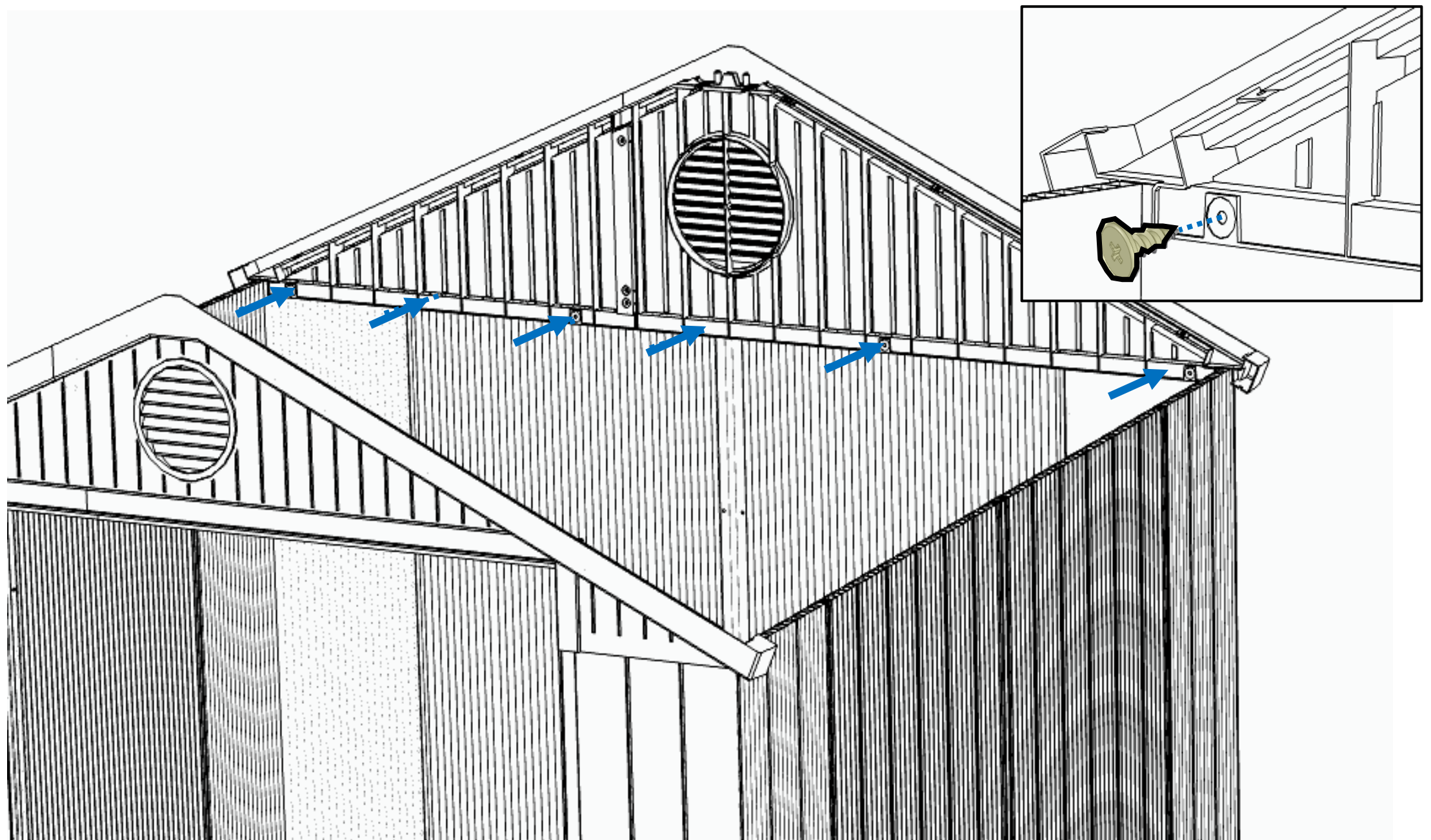
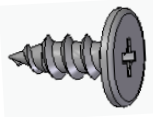

24

DRKM (x1)

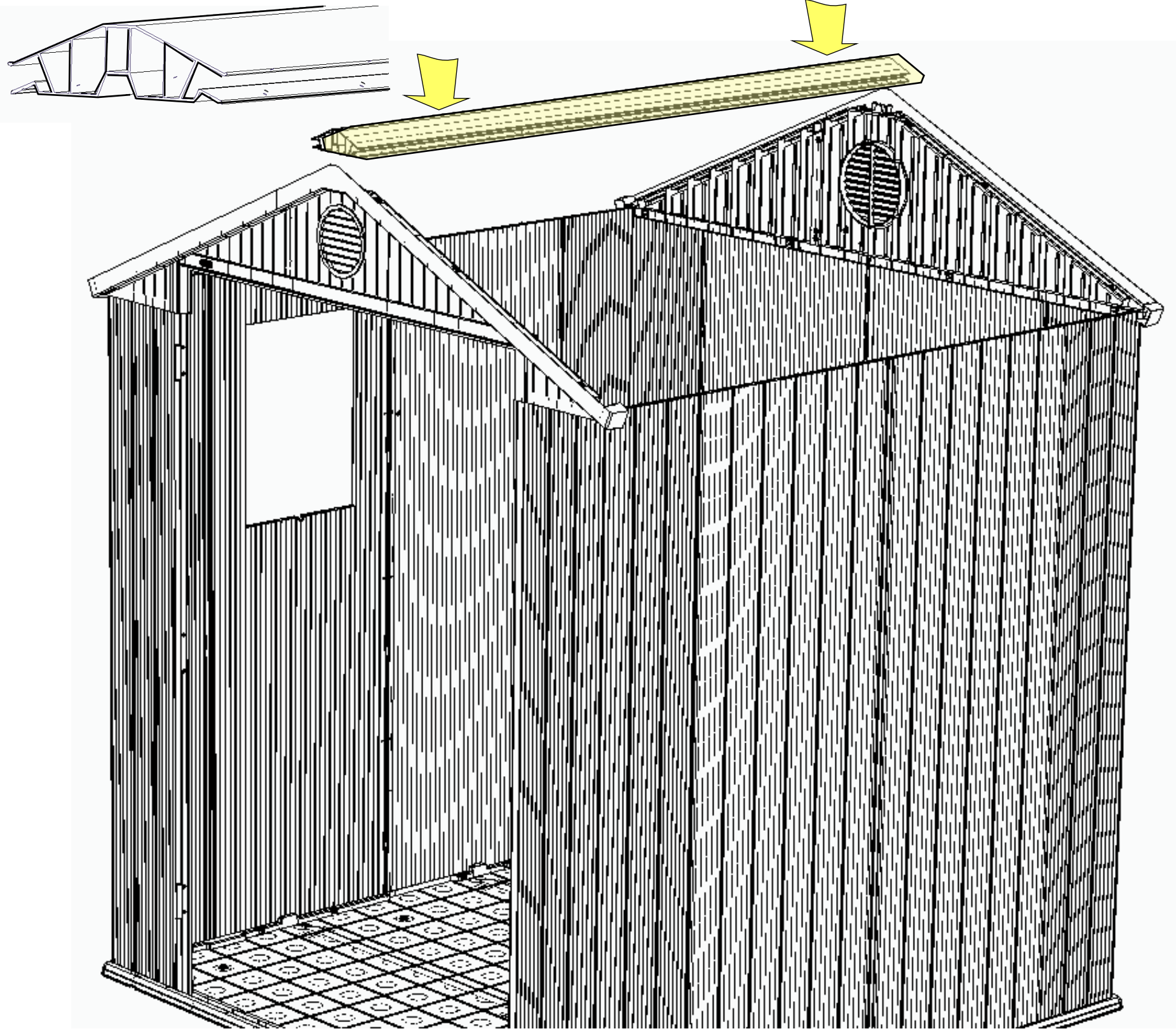

25

Sc12t (x4)

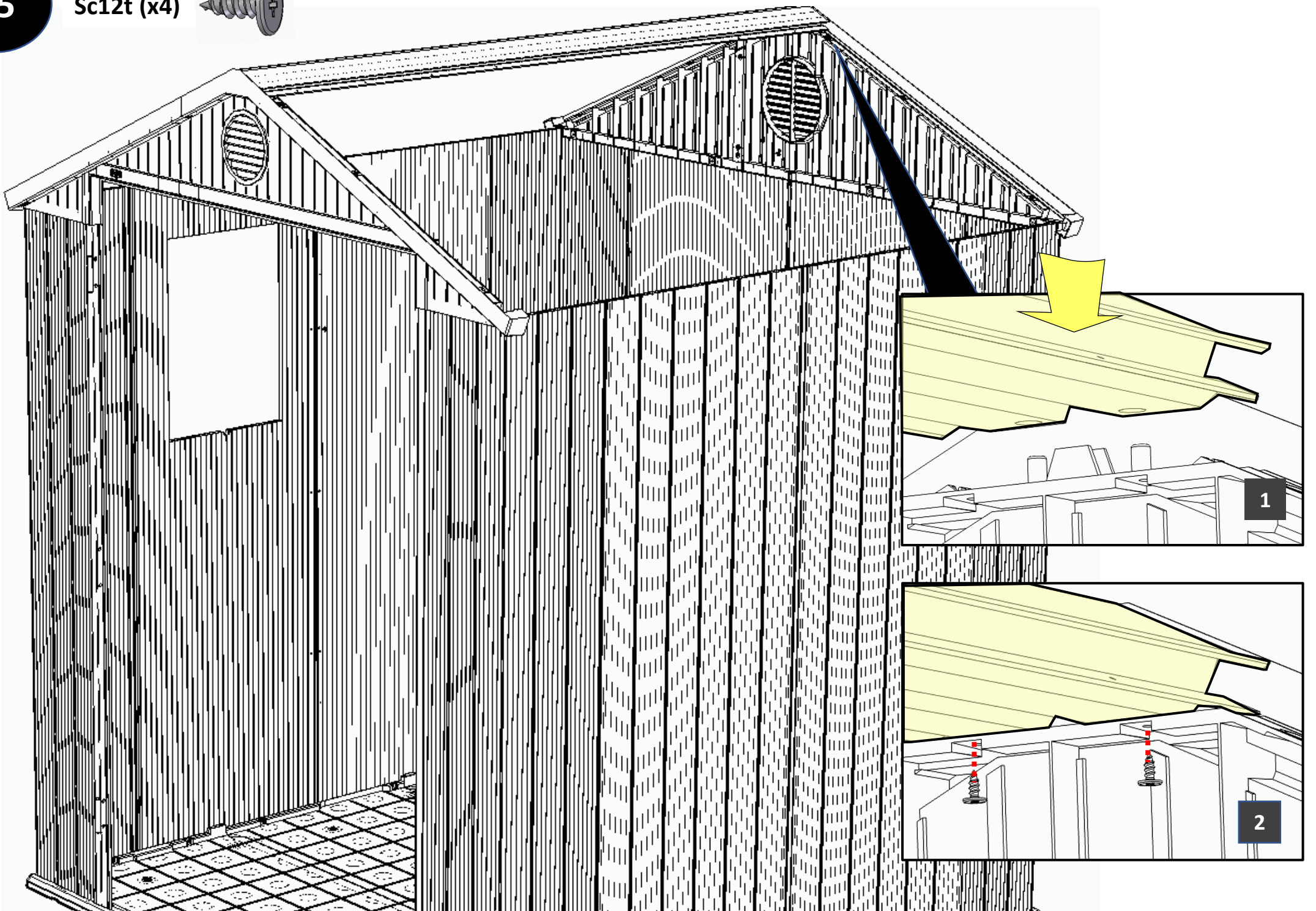
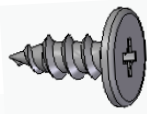

26

DRFM (x2)

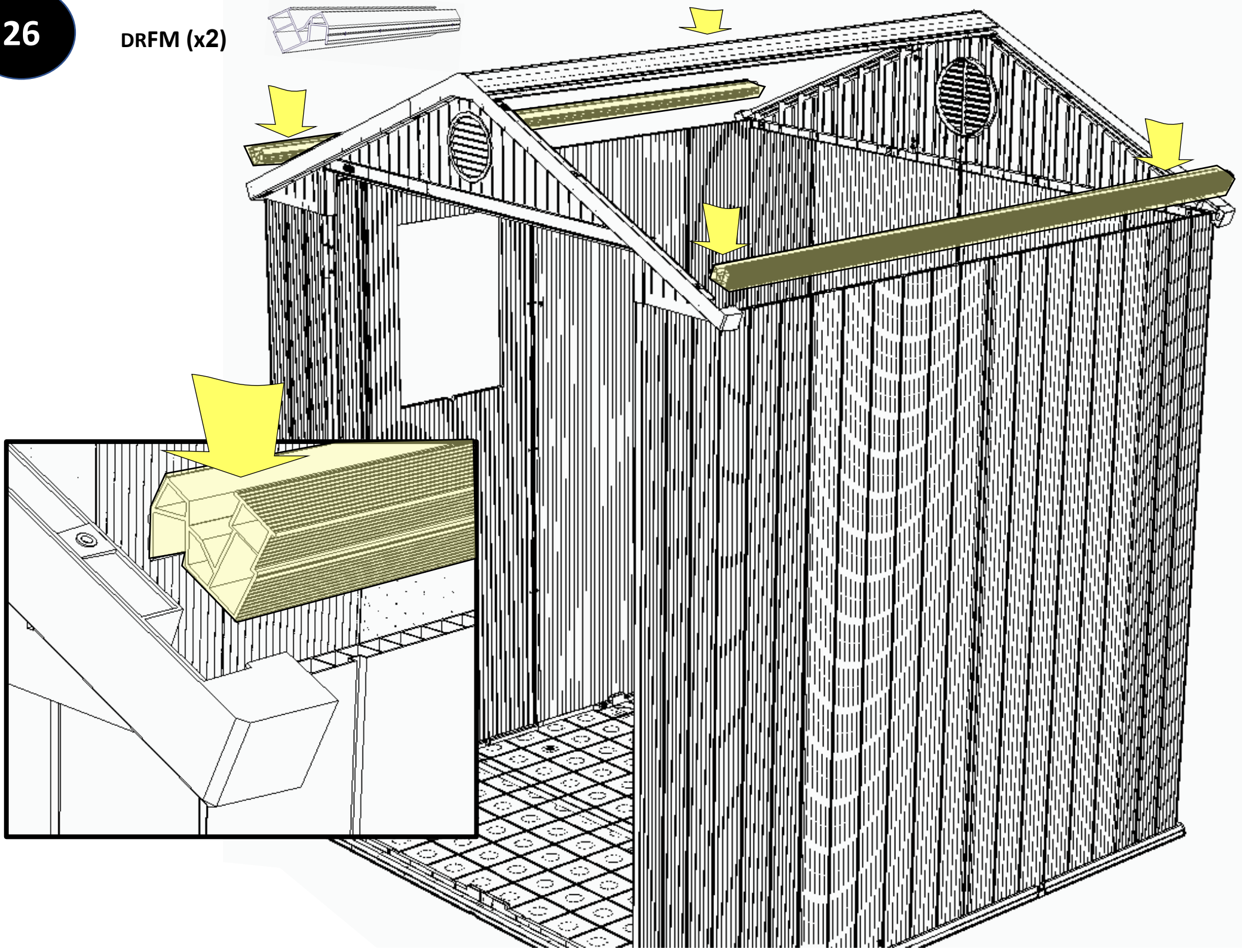

27

Sc12t (x12)

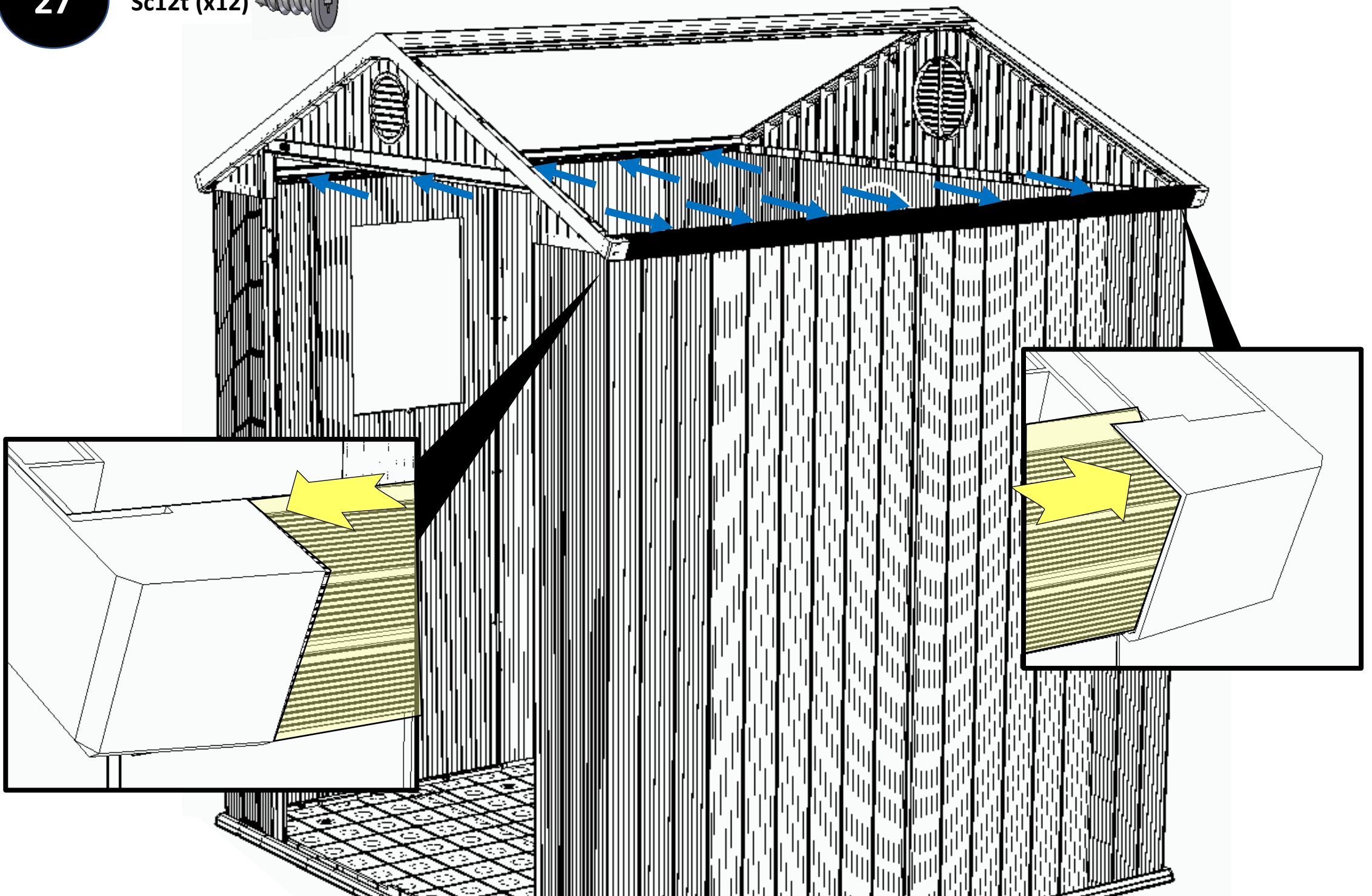
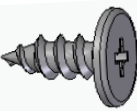

28

DRPM (x4)

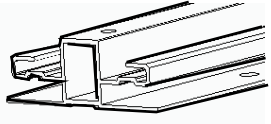

DRPT (x6)

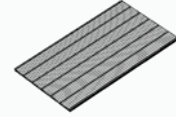

Sc7t (x24)

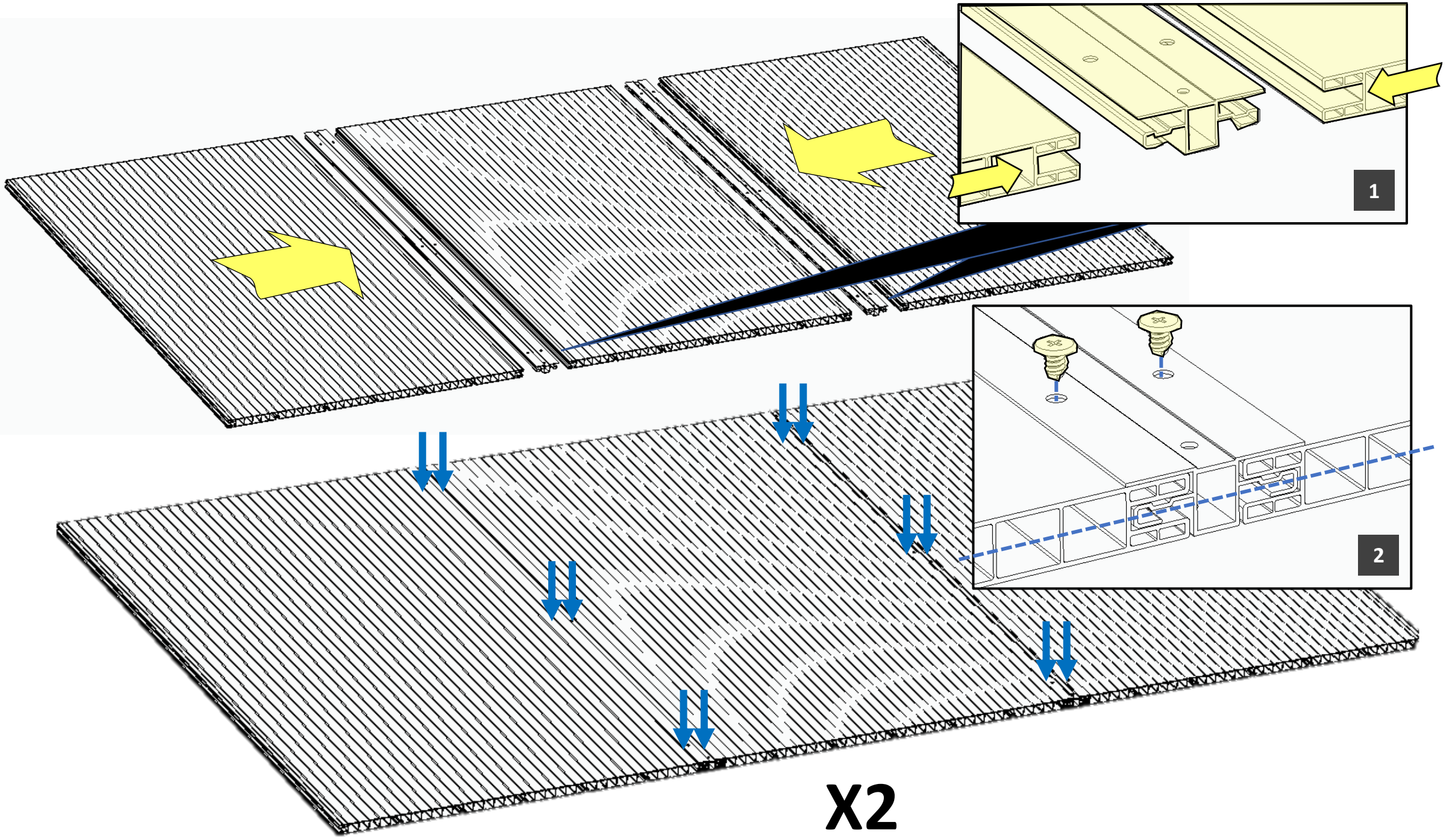
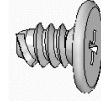

29

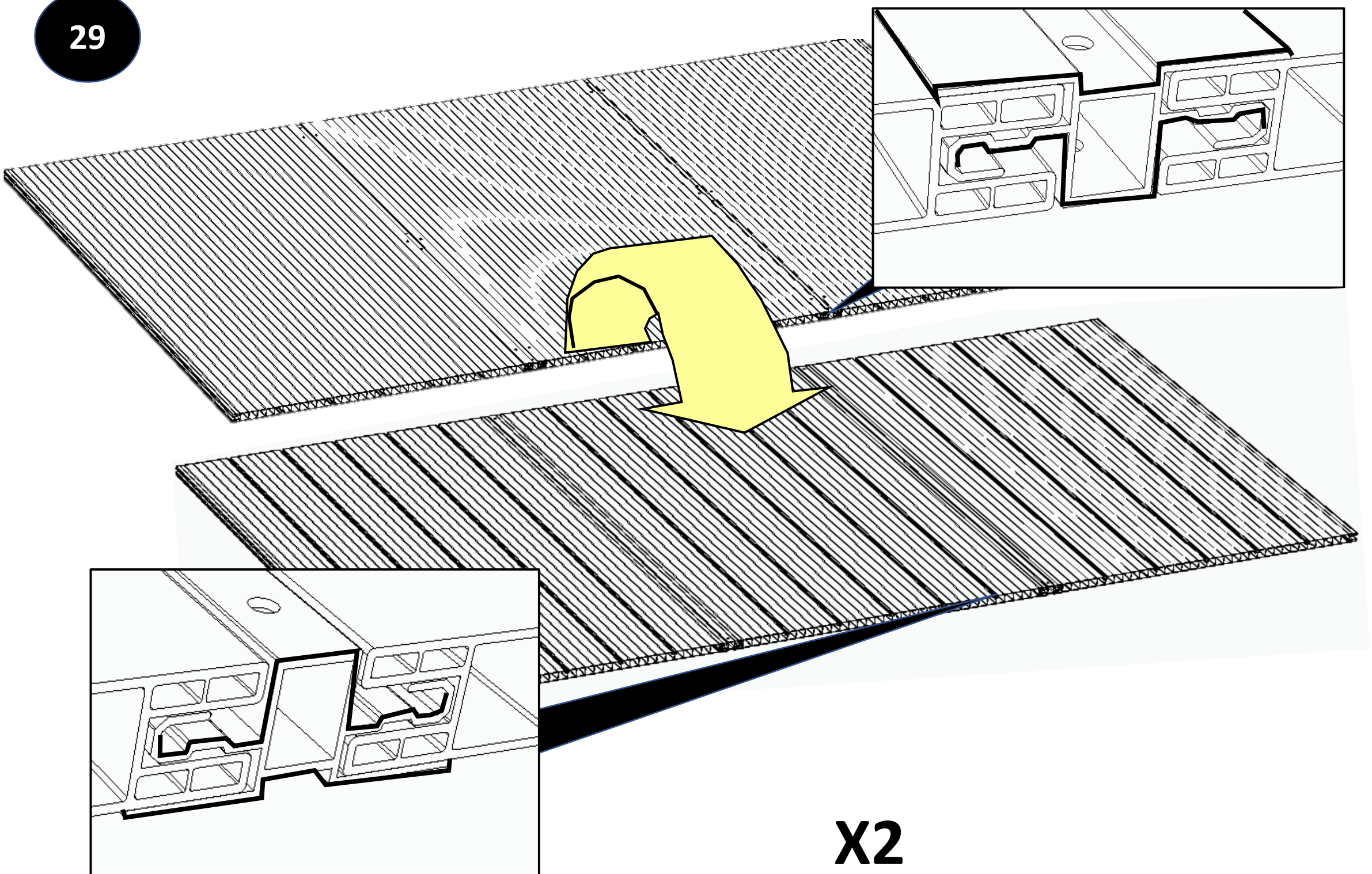

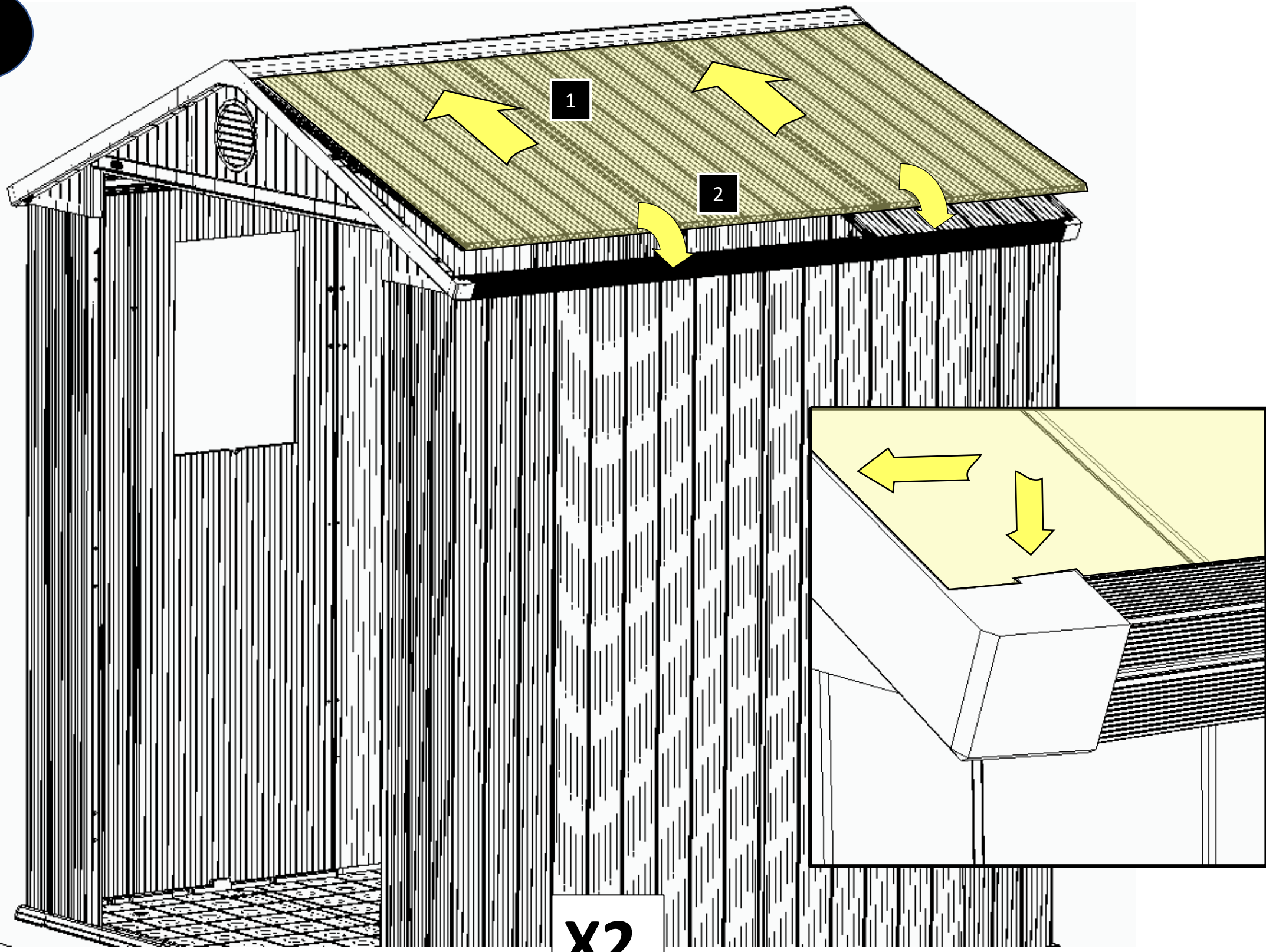

X2

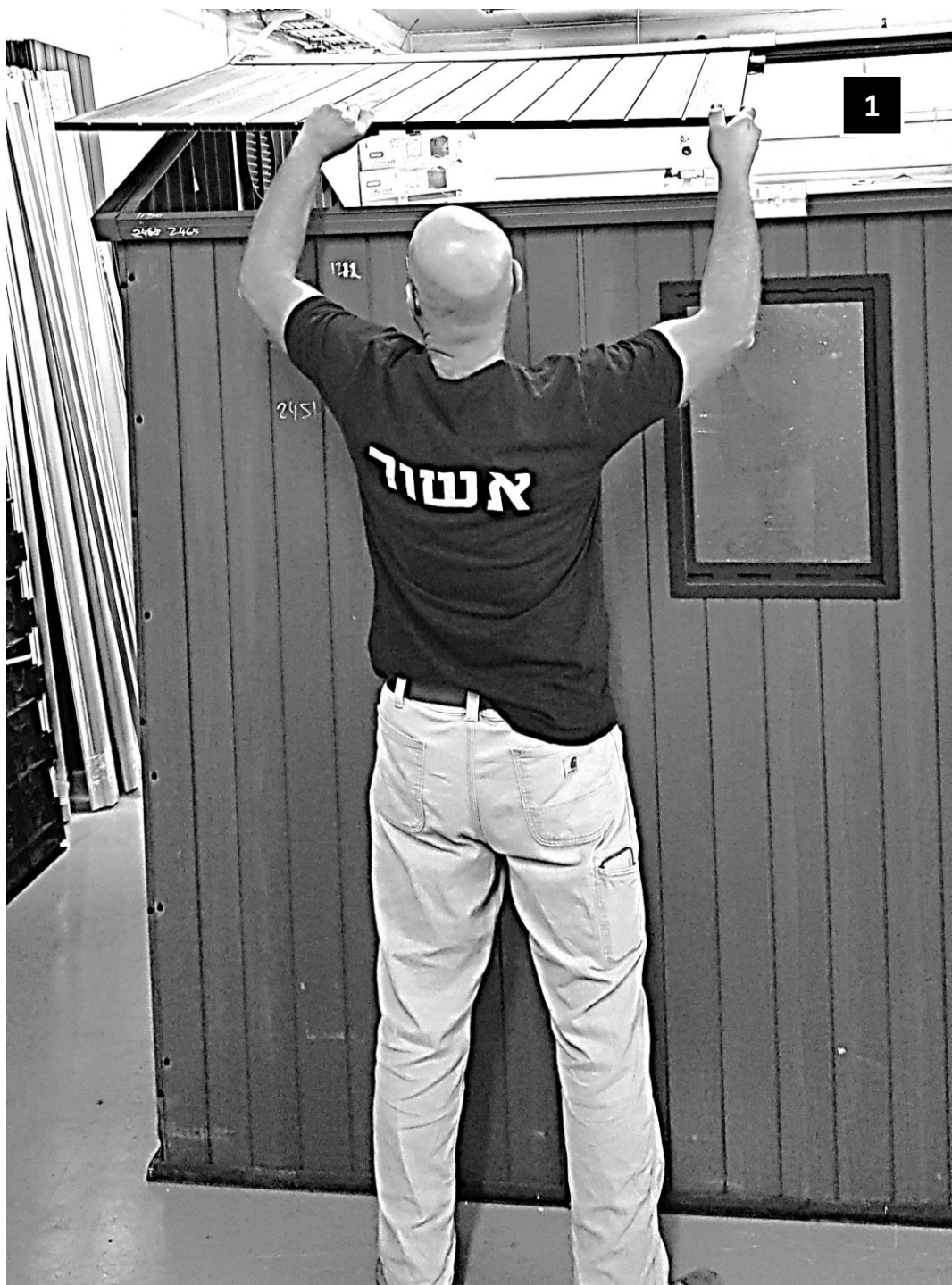

31

Sc12t x 12

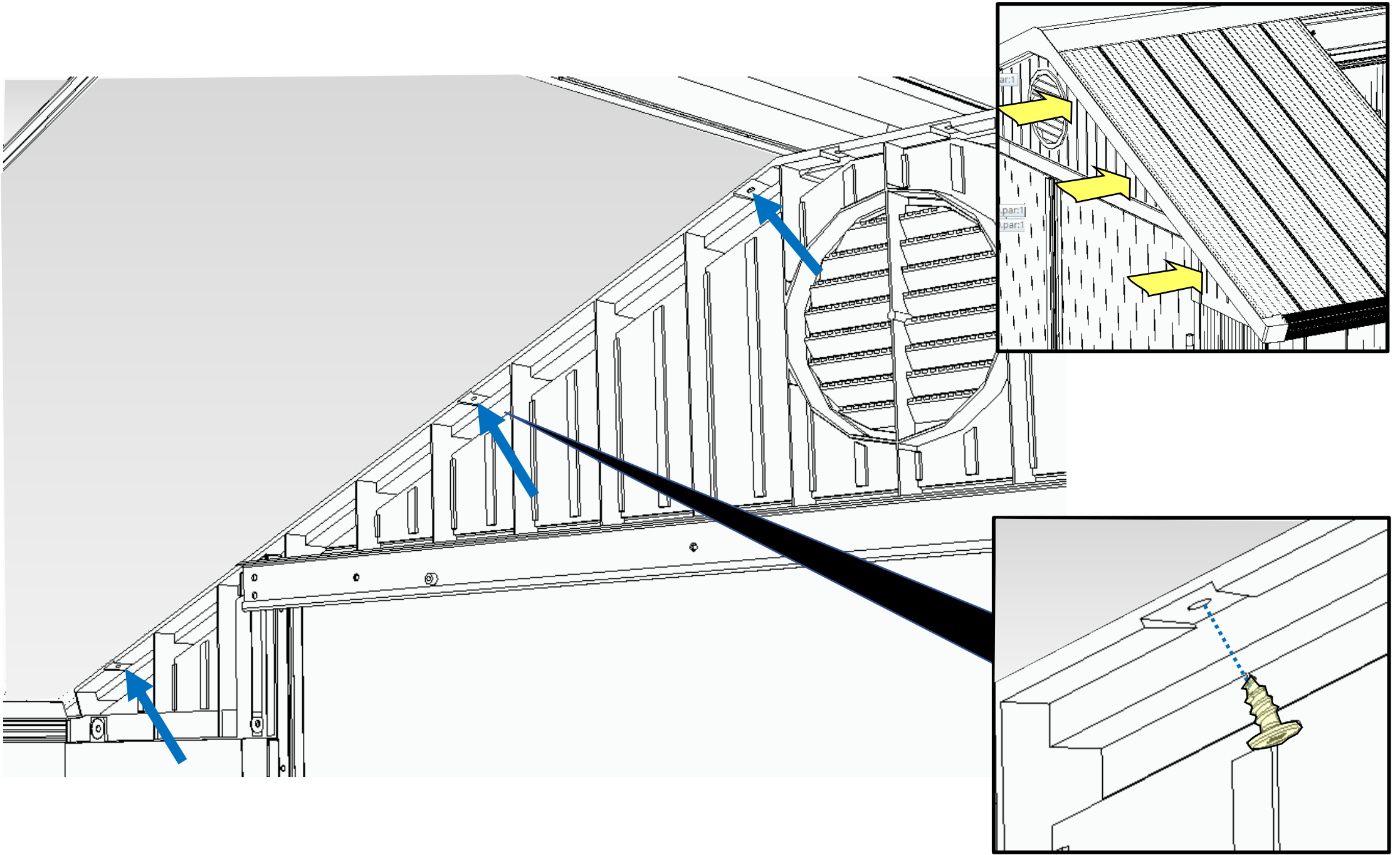
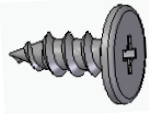

32

Sc36 (x4)

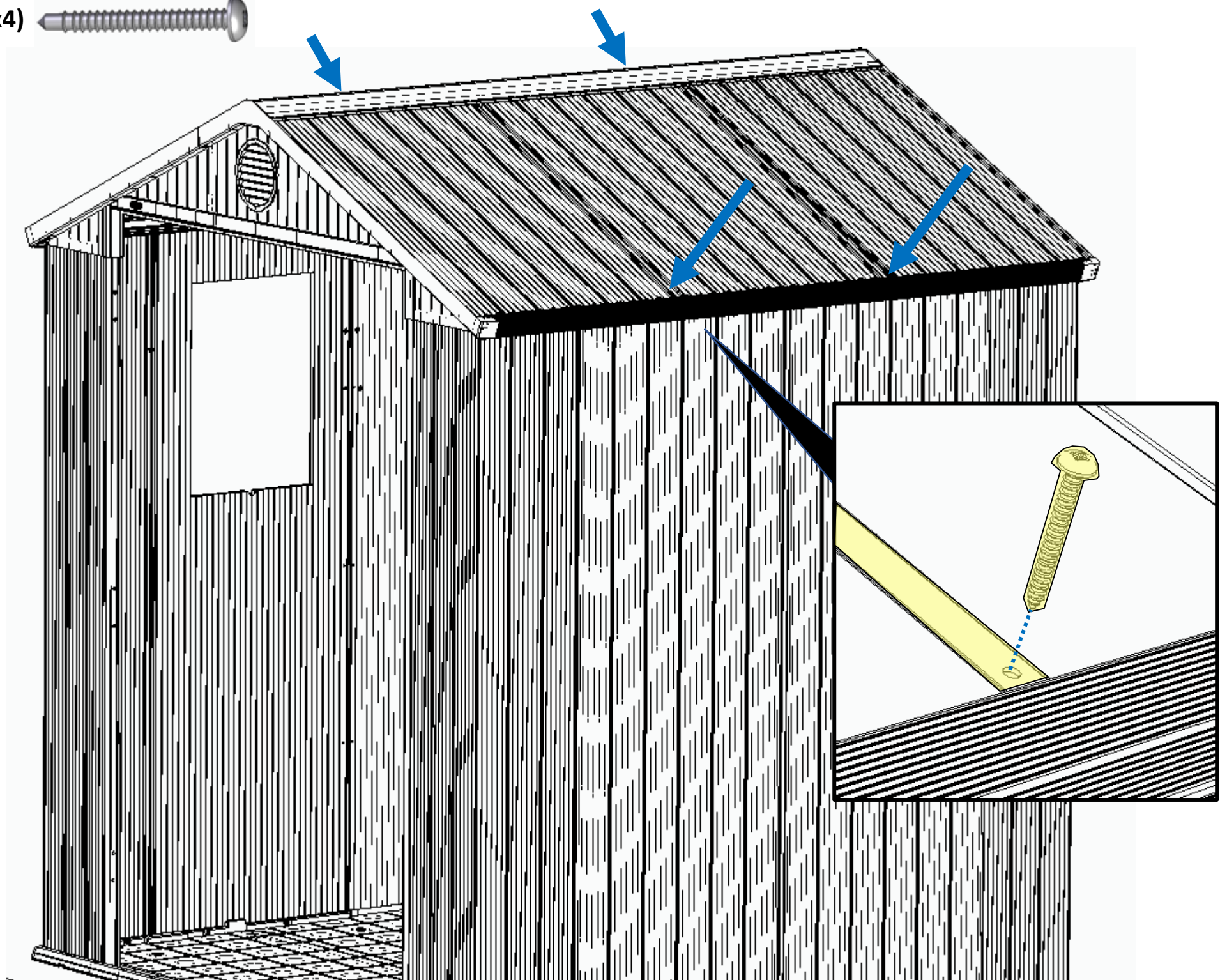

33

Sc36 (x12)

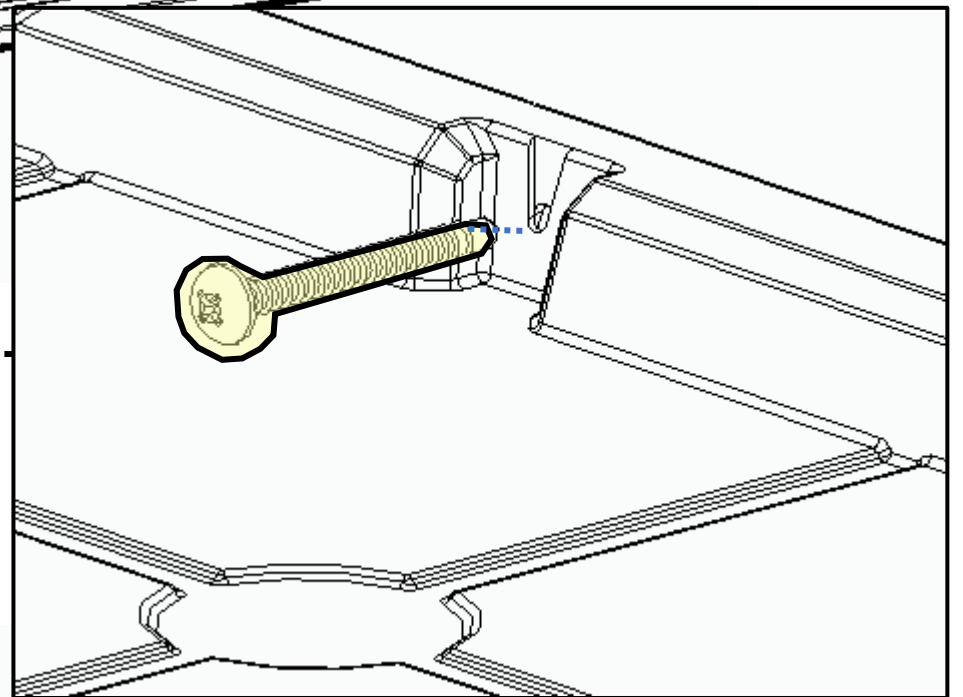
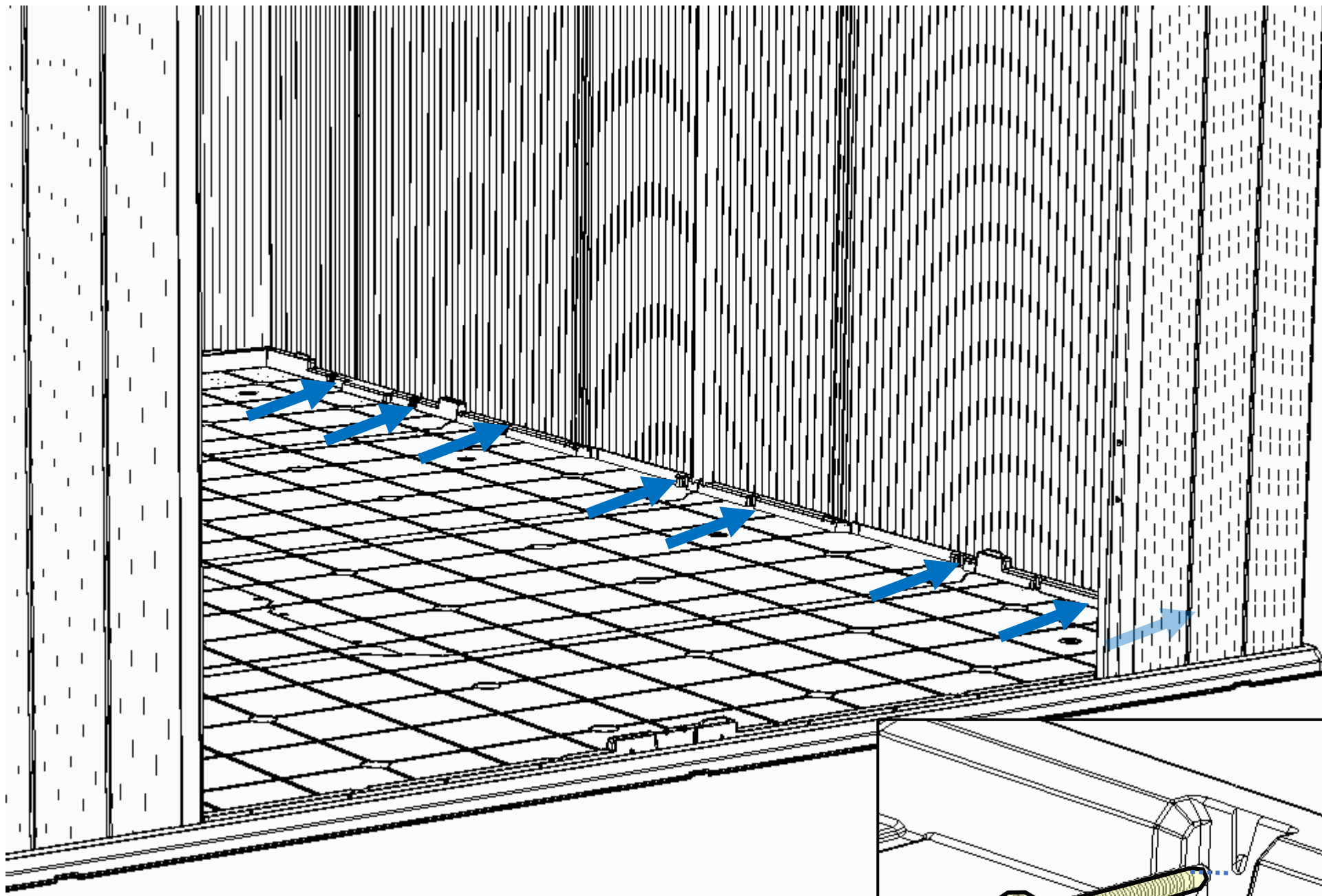

34

Sc36 (x8)

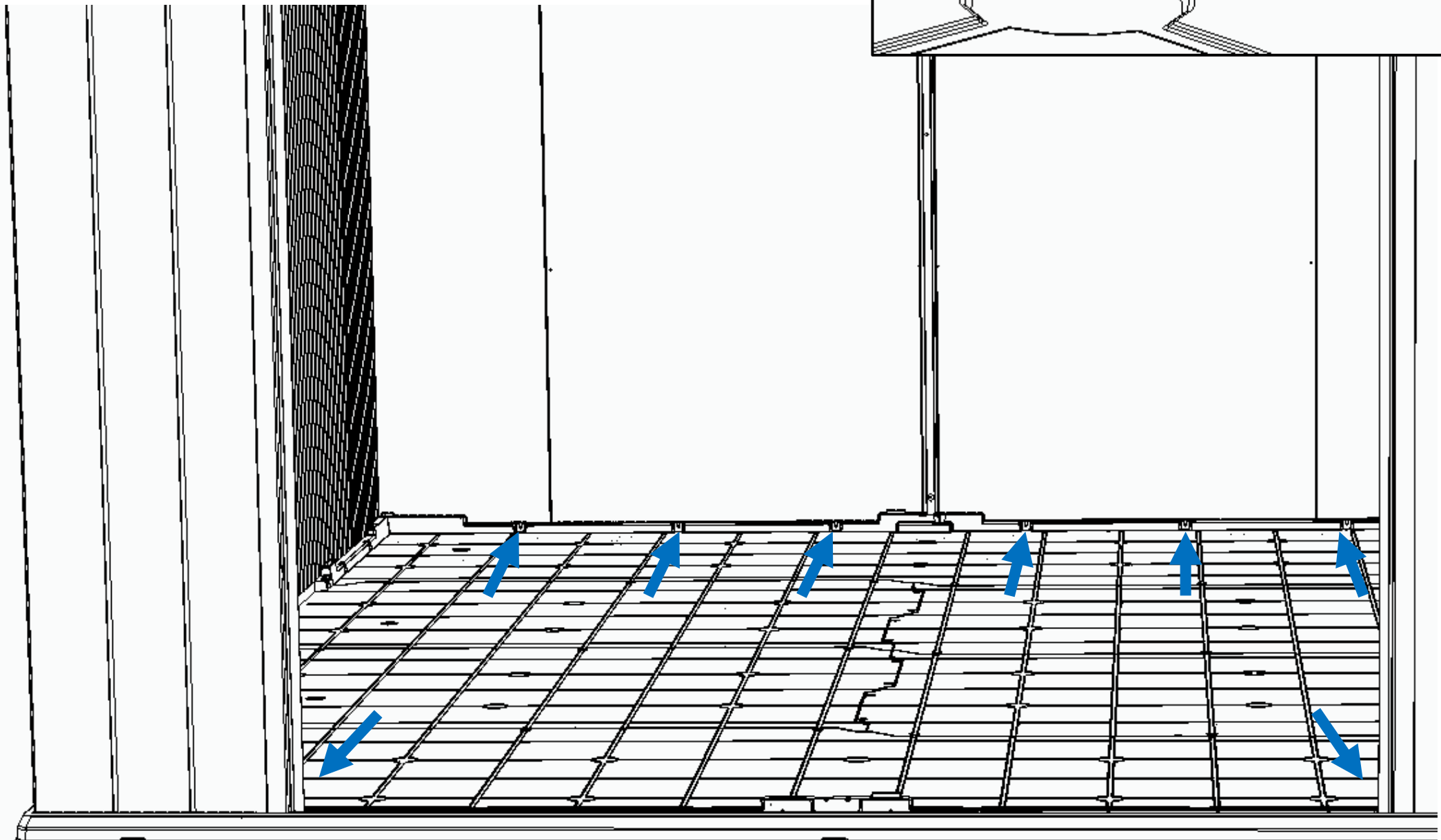

Doors assembly

35

DRPT (x2)

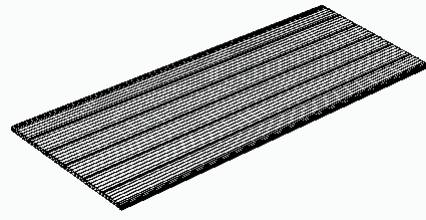

DRPD (x4)

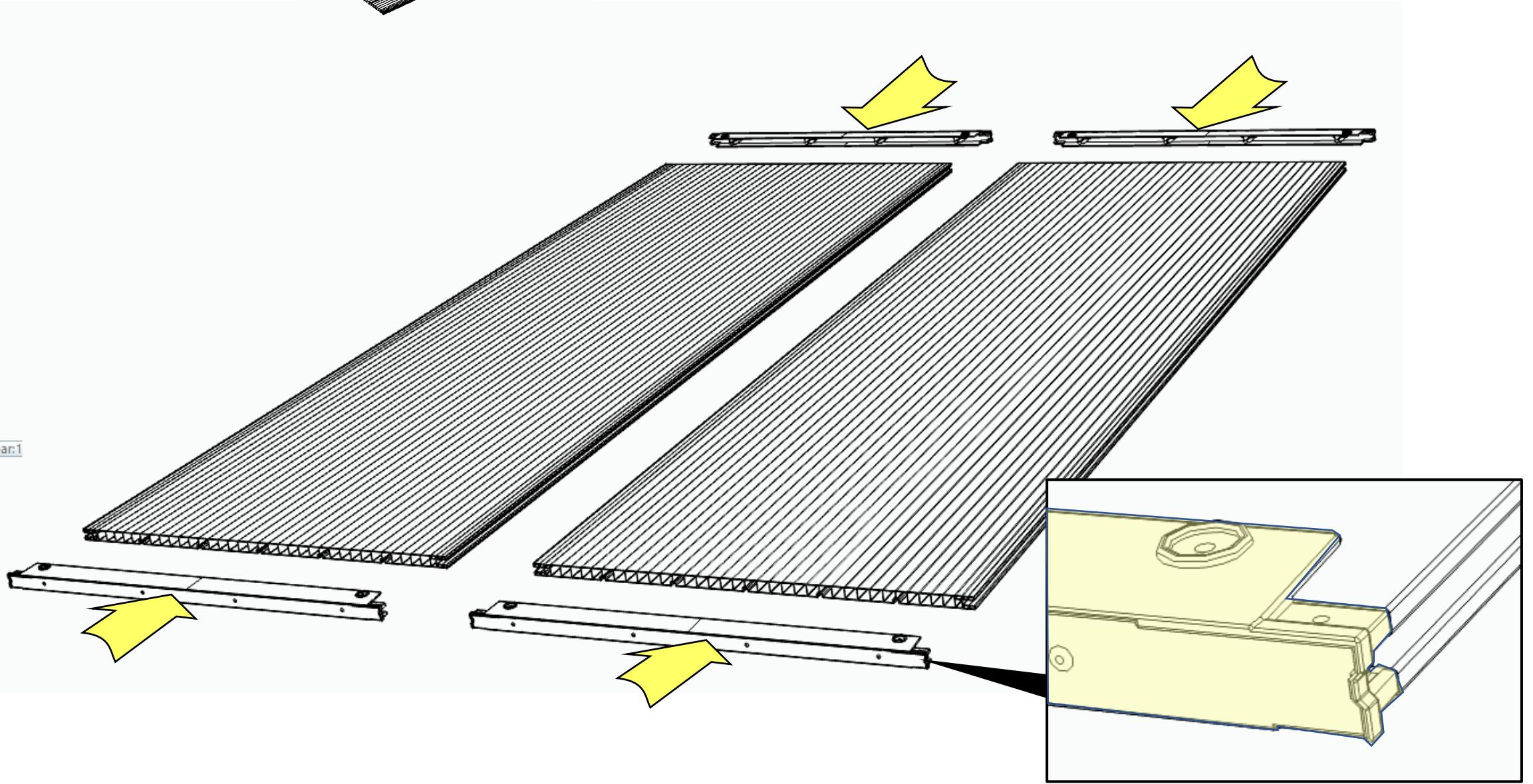
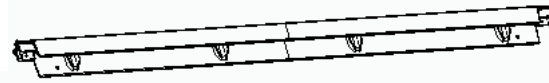

36

DRMA (x3)

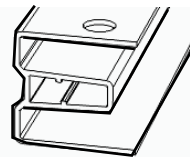

DRMW (x1)

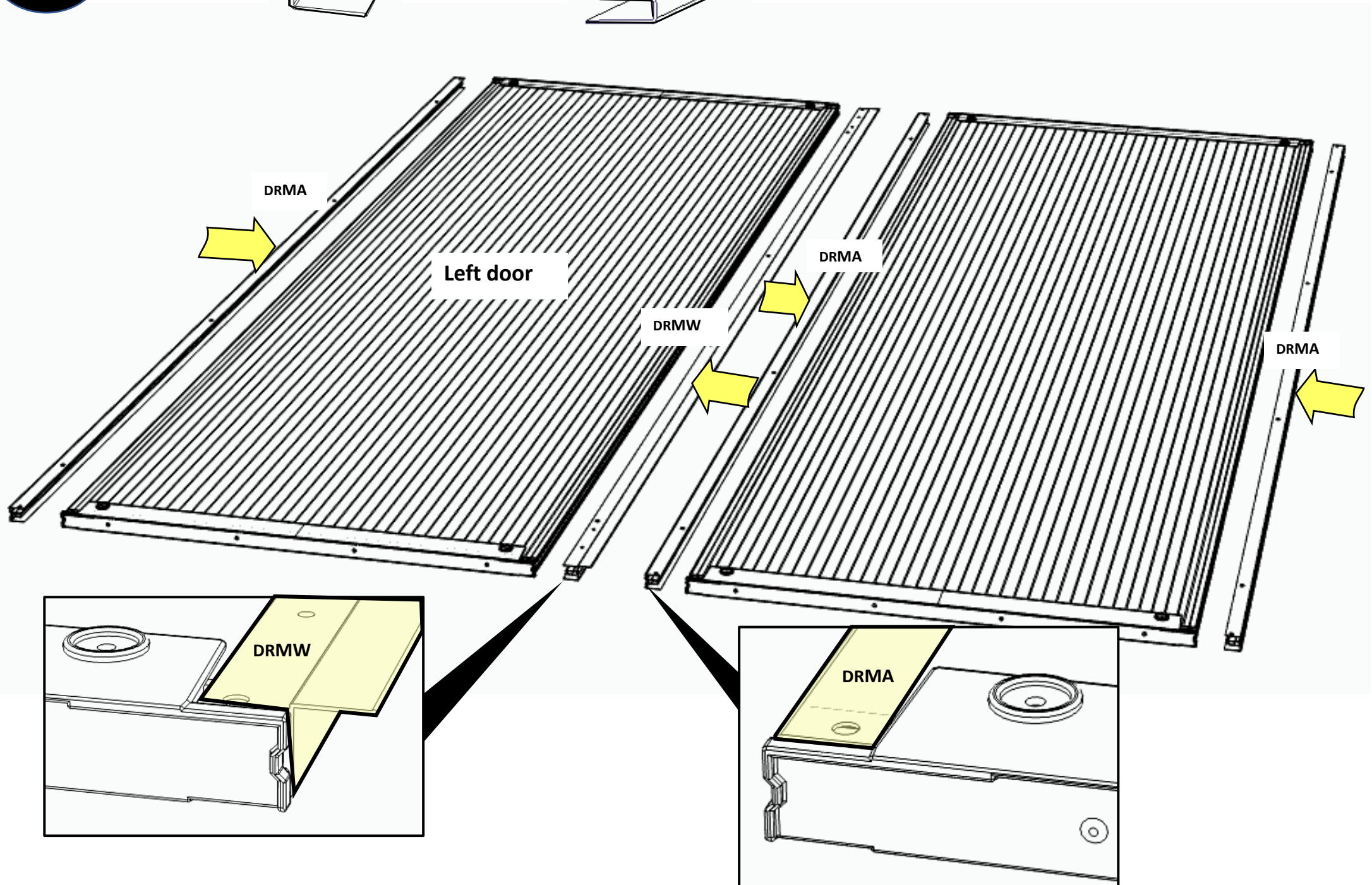
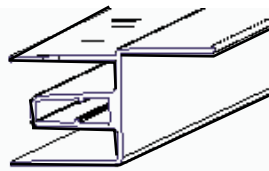

37

Sc12t (x8)

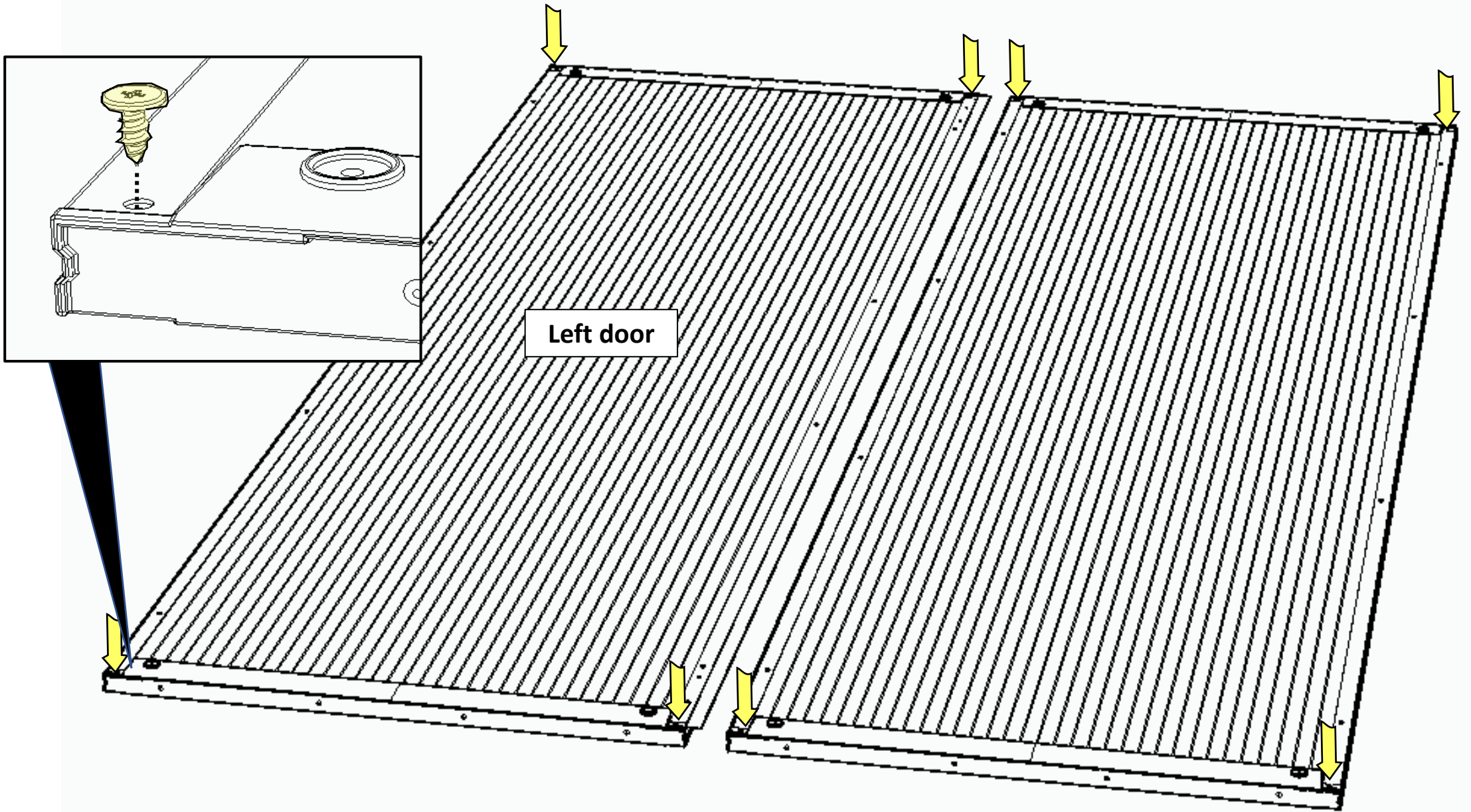
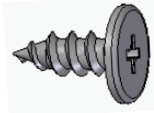

38

Sc12t (x24)

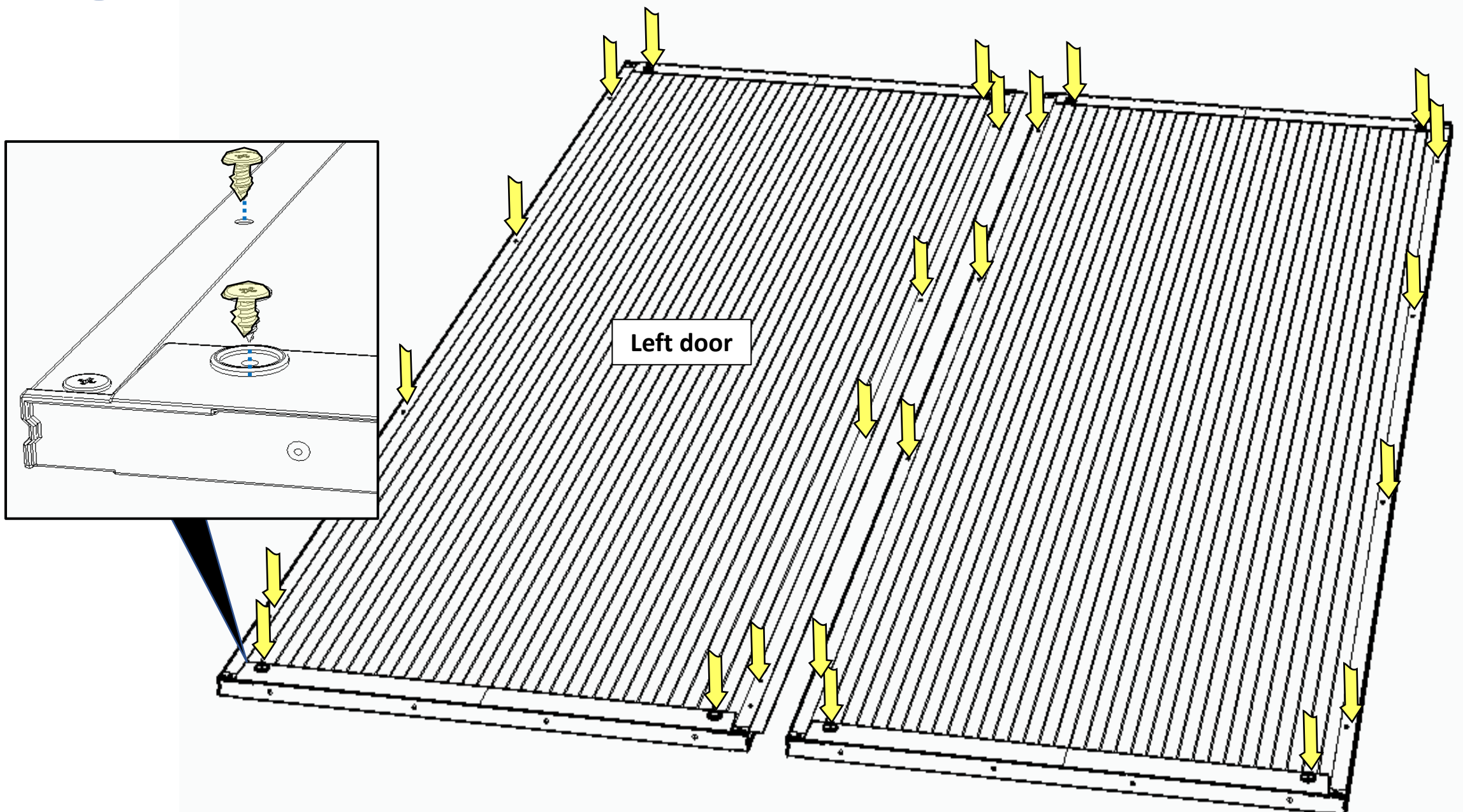
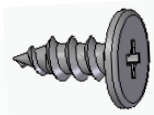

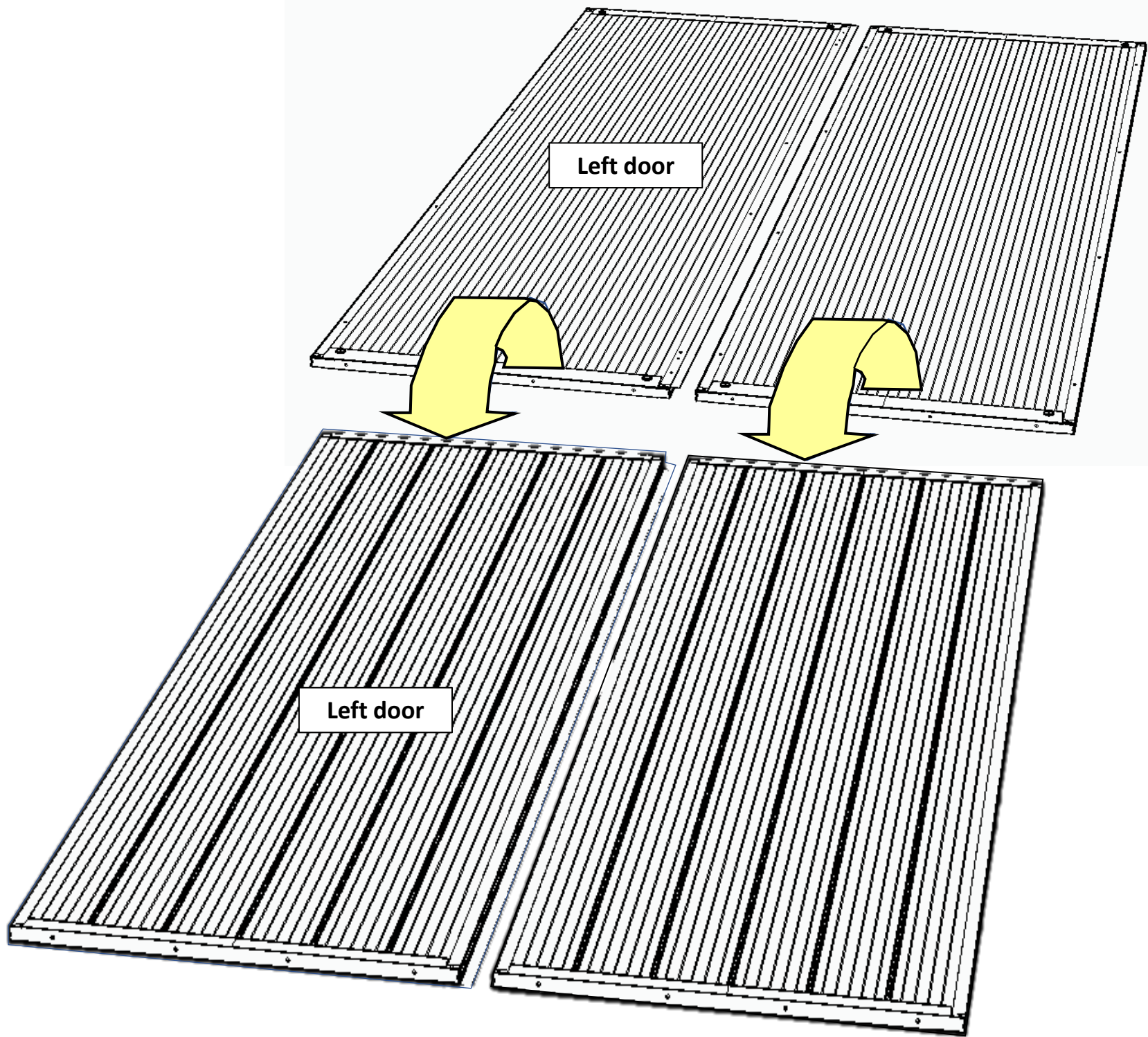

DRHG (x4)

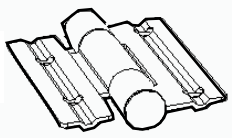

sw15d (x8)

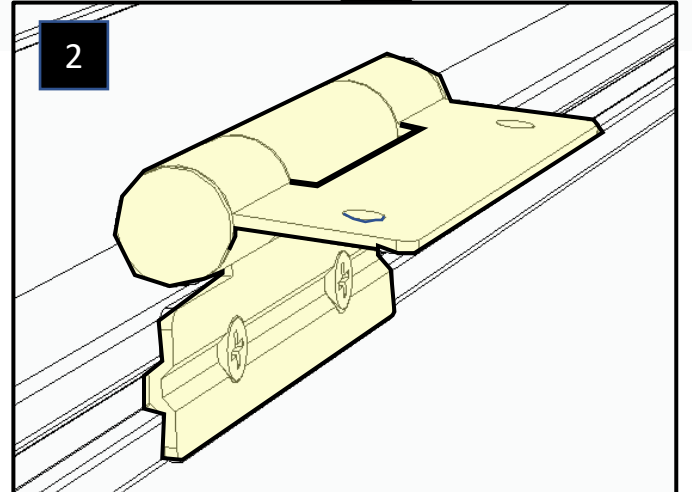
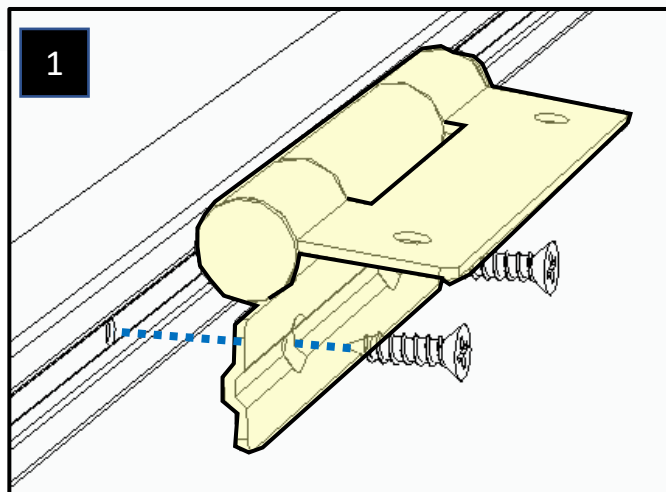
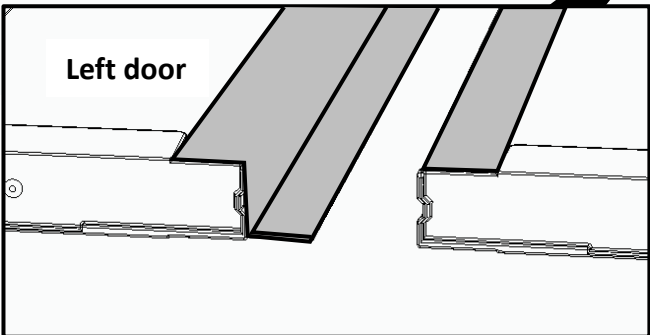
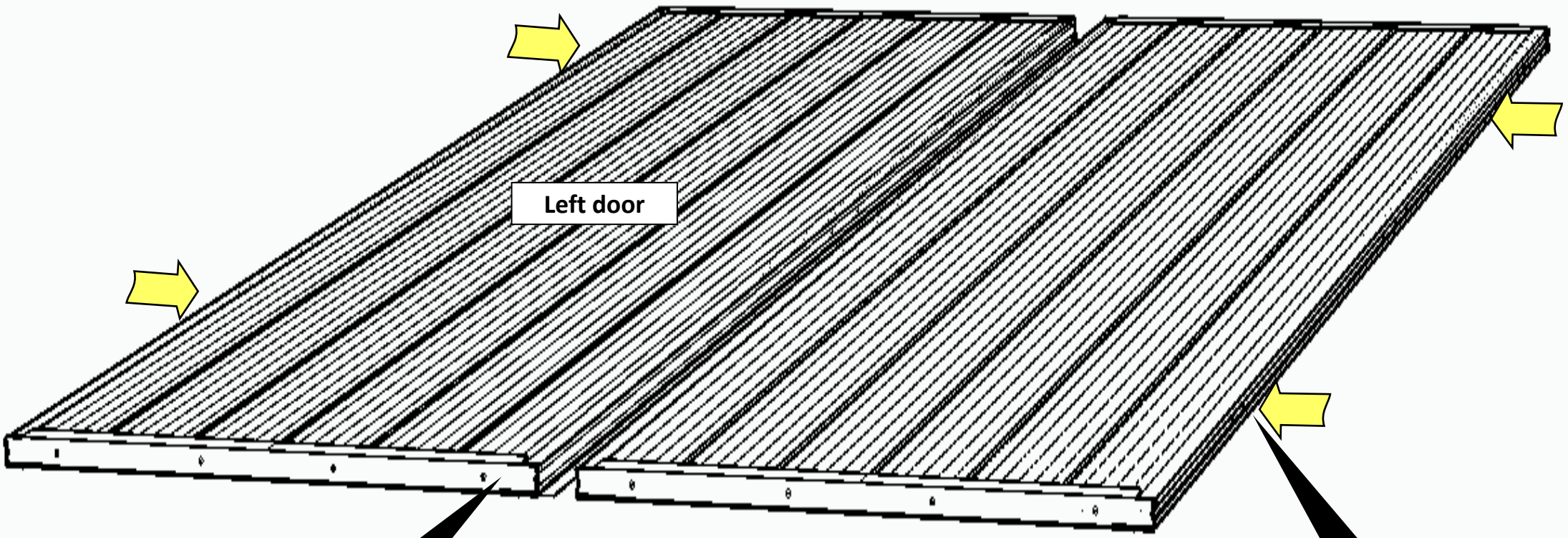

41

sw15d (x8)

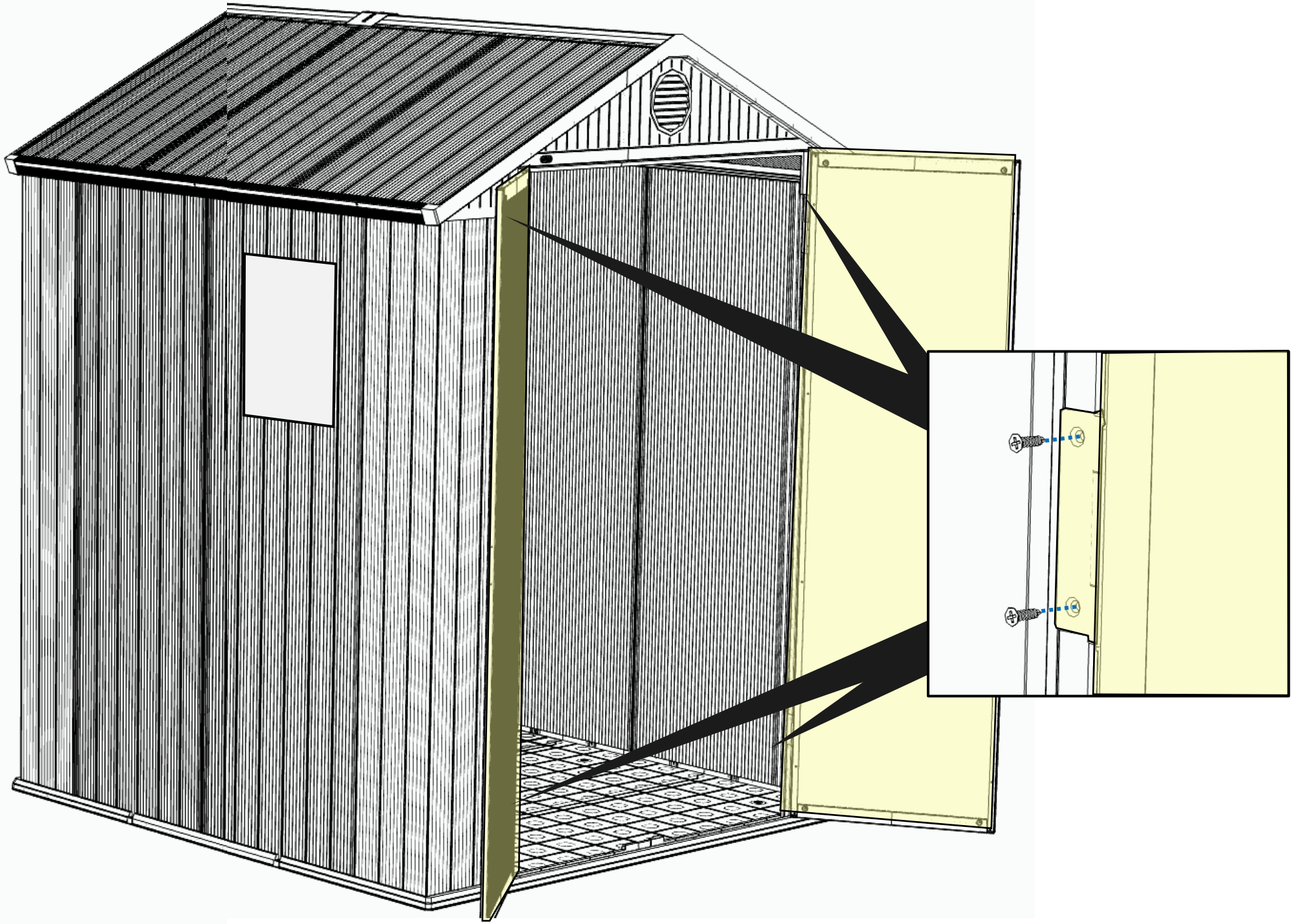

42

FLA (x2)

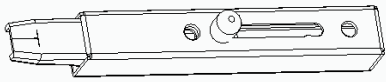

scw8 (x4)



DRLH (x1)

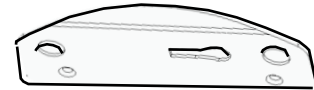

sw15d (x2)

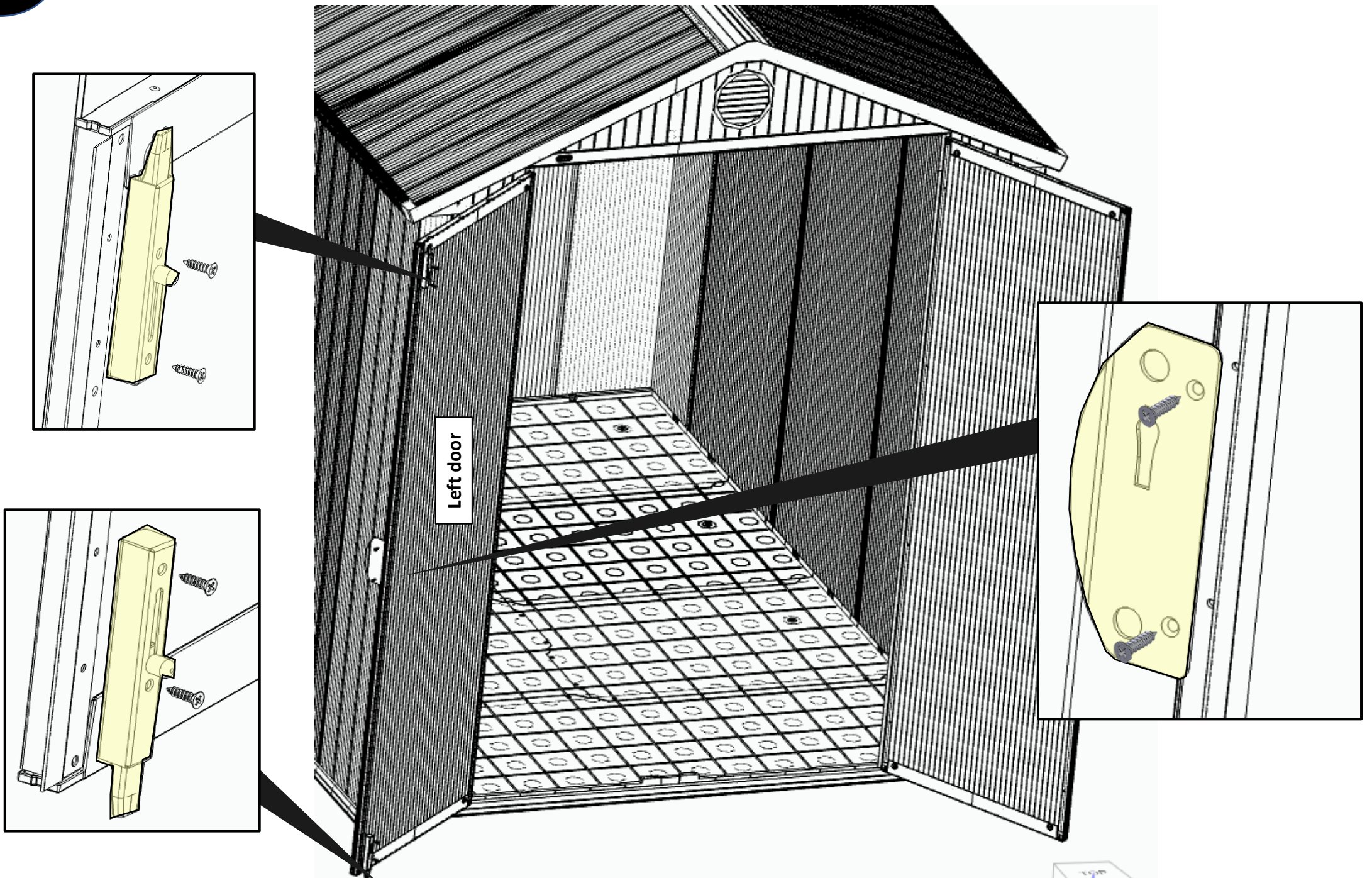

43

sw15d (x3)



DRLM (x1)

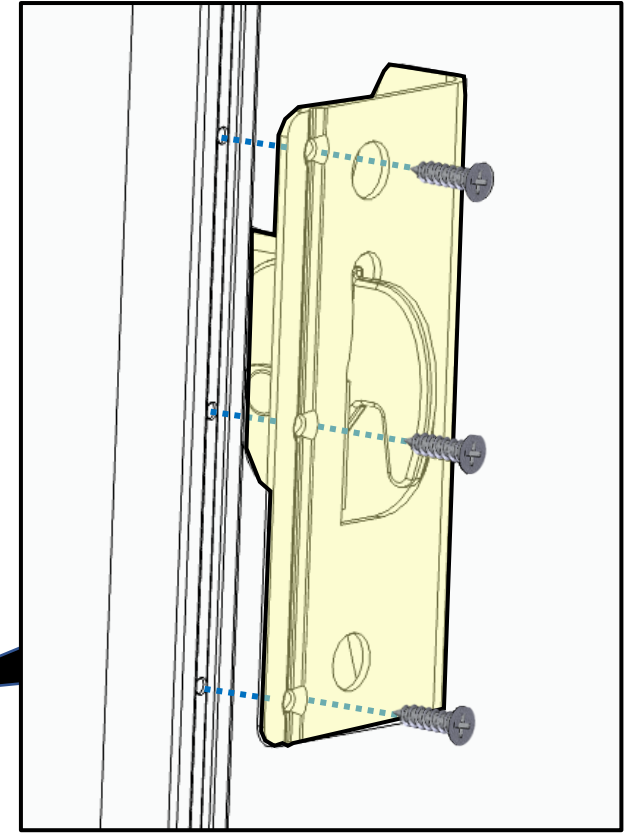
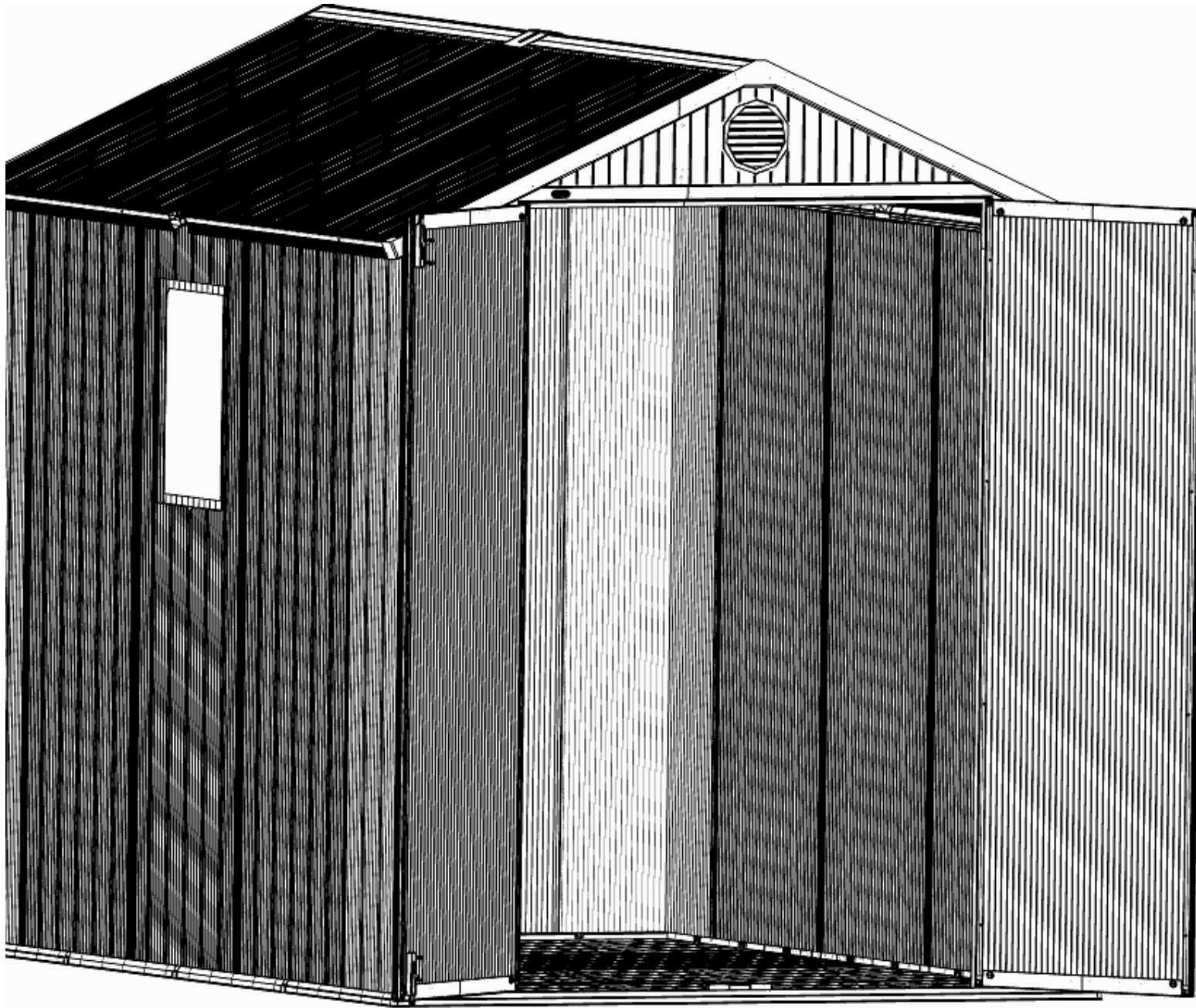
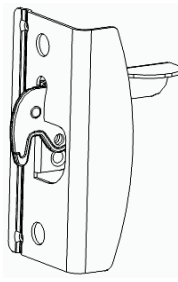

44

WI-OUT(x1)

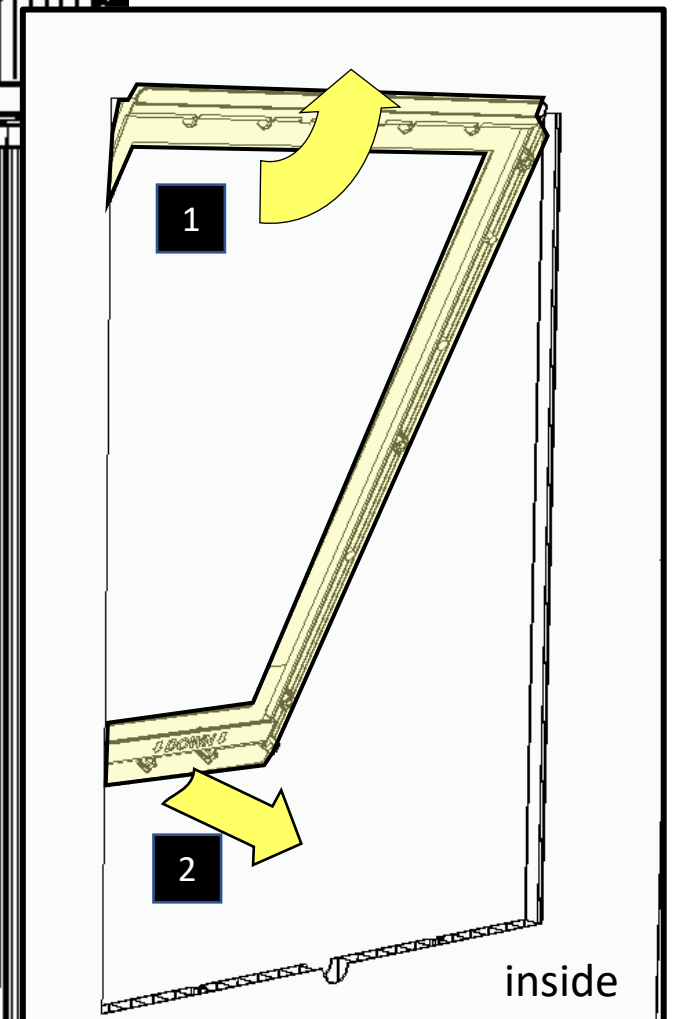
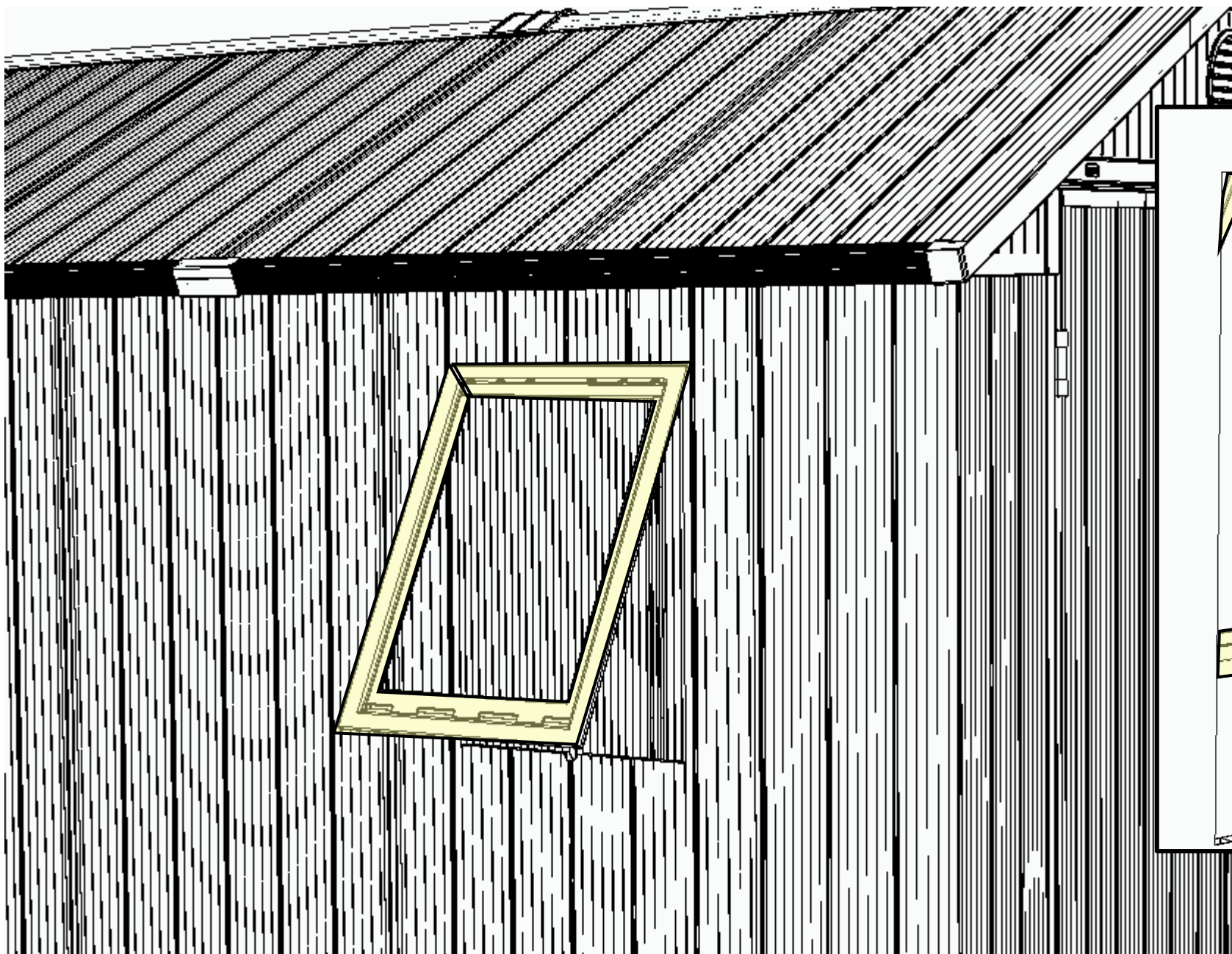
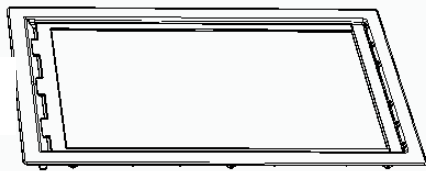

45

MDG (x1)

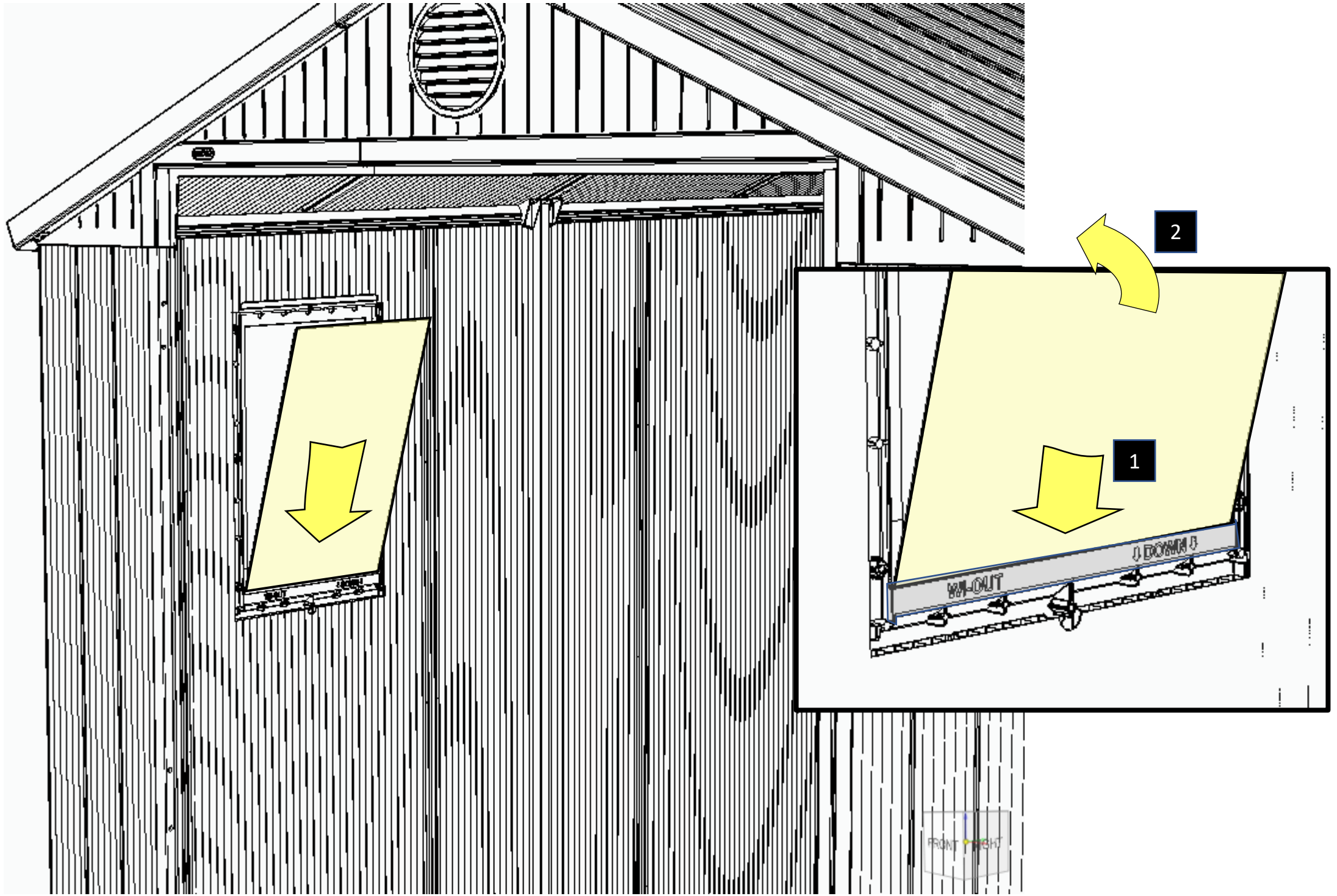

46

WI-IN (x1)

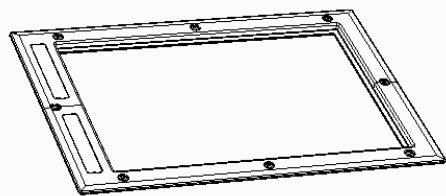

Sc12t (x8)

