

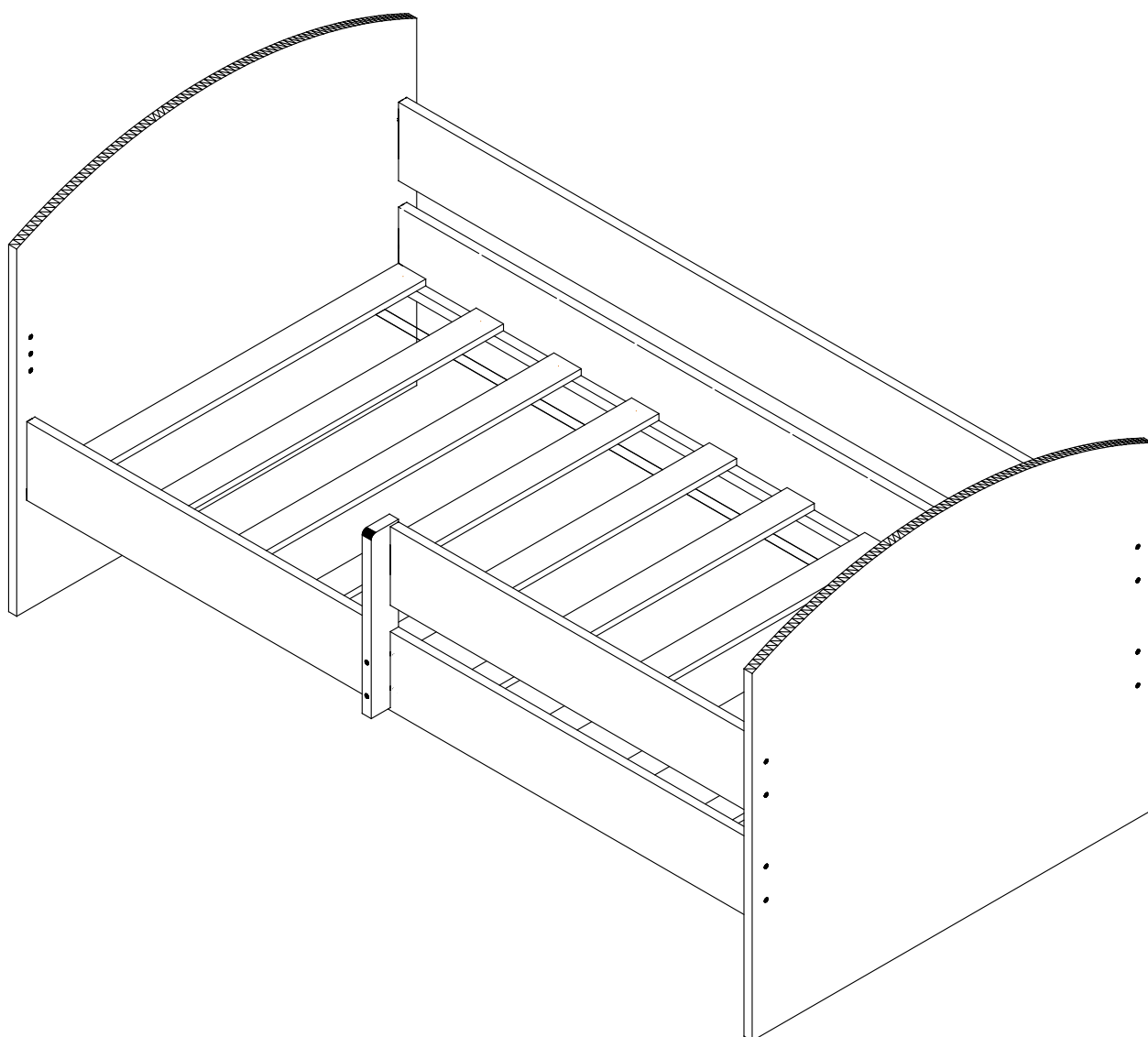





Victoria

1548_135107

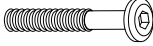

1548_135107

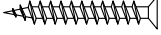
A		M6*70MM	X16PC		D		M6*50MM	X2PC	
B			X16PC		E		M6*20MM	X2PC	
C		Φ8*30MM	X8PC		F		Φ4*30MM	X20PC	

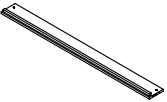
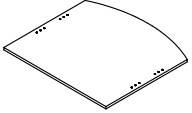
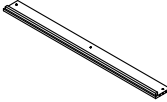
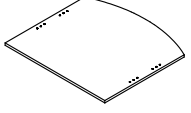
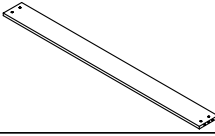
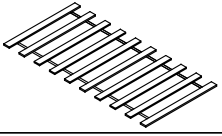
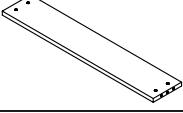
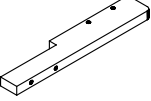
1		1600*150*18	X1PC	2/2	6		880*800*18	X1PC	1/1
2		1600*150*18	X1PC	2/2	7		880*800*18	X1PC	1/1
3		1600*150*18	X1PC	2/2	8			X1PC	1/1
4		800*150*18	X1PC	2/2					
5		350*60*20	X1PC	2/2					

FR : SAV/INFORMATION /VIDEO/CONTACT

EN: AFTER-SALES SERVICE/INFORMATION/VIDEO/CONTACT

DE : REPARATUR-SERVICE UND ERSATZTEILE /INFORMATIONEN /VIDEO/KONTAKT

ES: SERVICIO POST-VENTA/INFORMACION/VIDEO/CONTACTO

IT: SERVIZIO ASSISTENZA/INFORMAZIONI/VIDEO/CONTATTO

PT: SERVIÇO PÓS-VENDA/INFORMAÇÕES/VIDEO/CONTATO

PL: SERWIS TECHNICZNY/INFORMACJE/WIDEO/KONTAKT

NE: AFTER SALES SERVICE/INFORMATIE/VIDEO/CONTACT

HE: רשקתל/ואדיוור / עדימ/תוריקמו תוריש רחאל



SAV.HABITATETJARDIN.COM

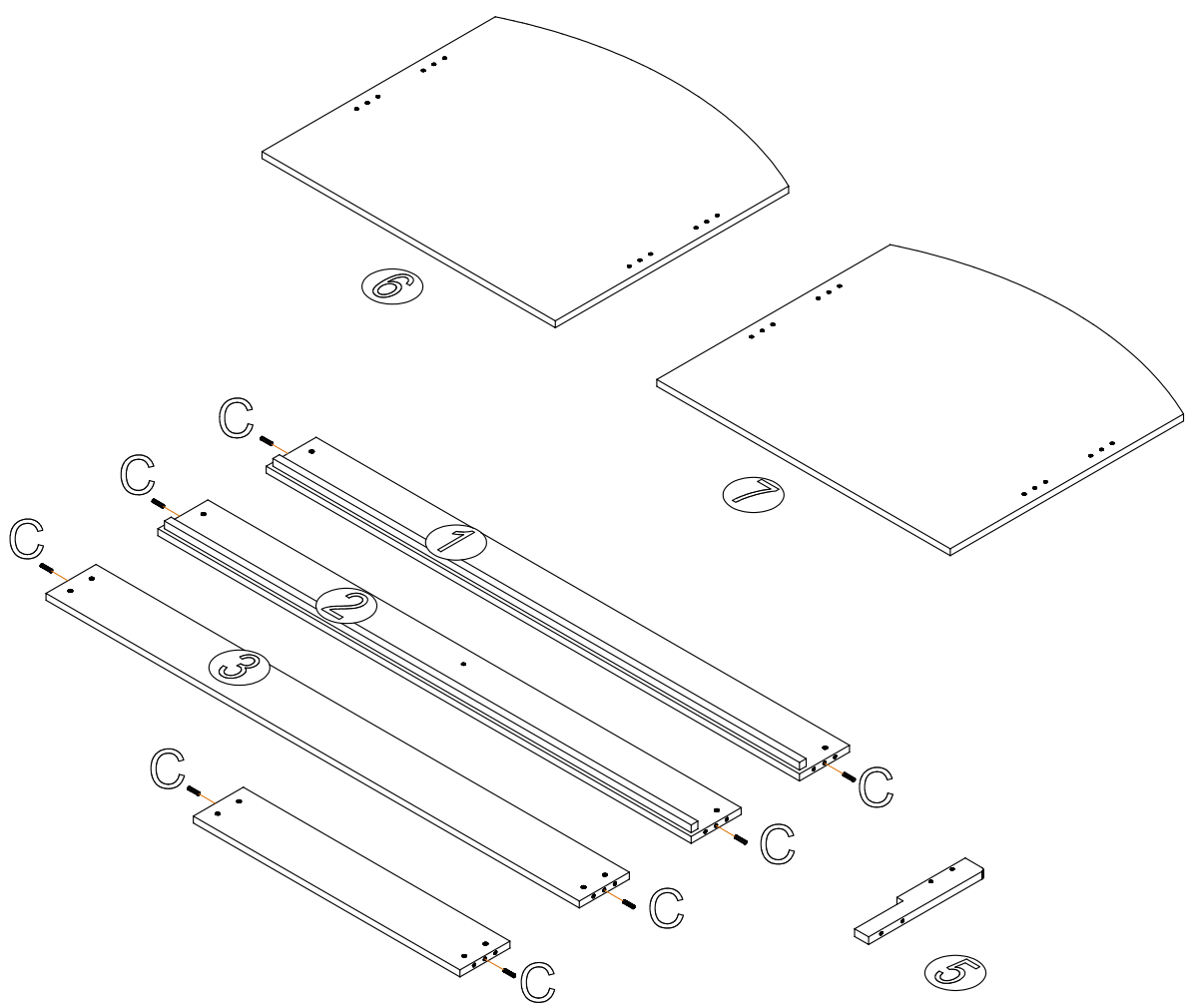

2/5
2022-2023

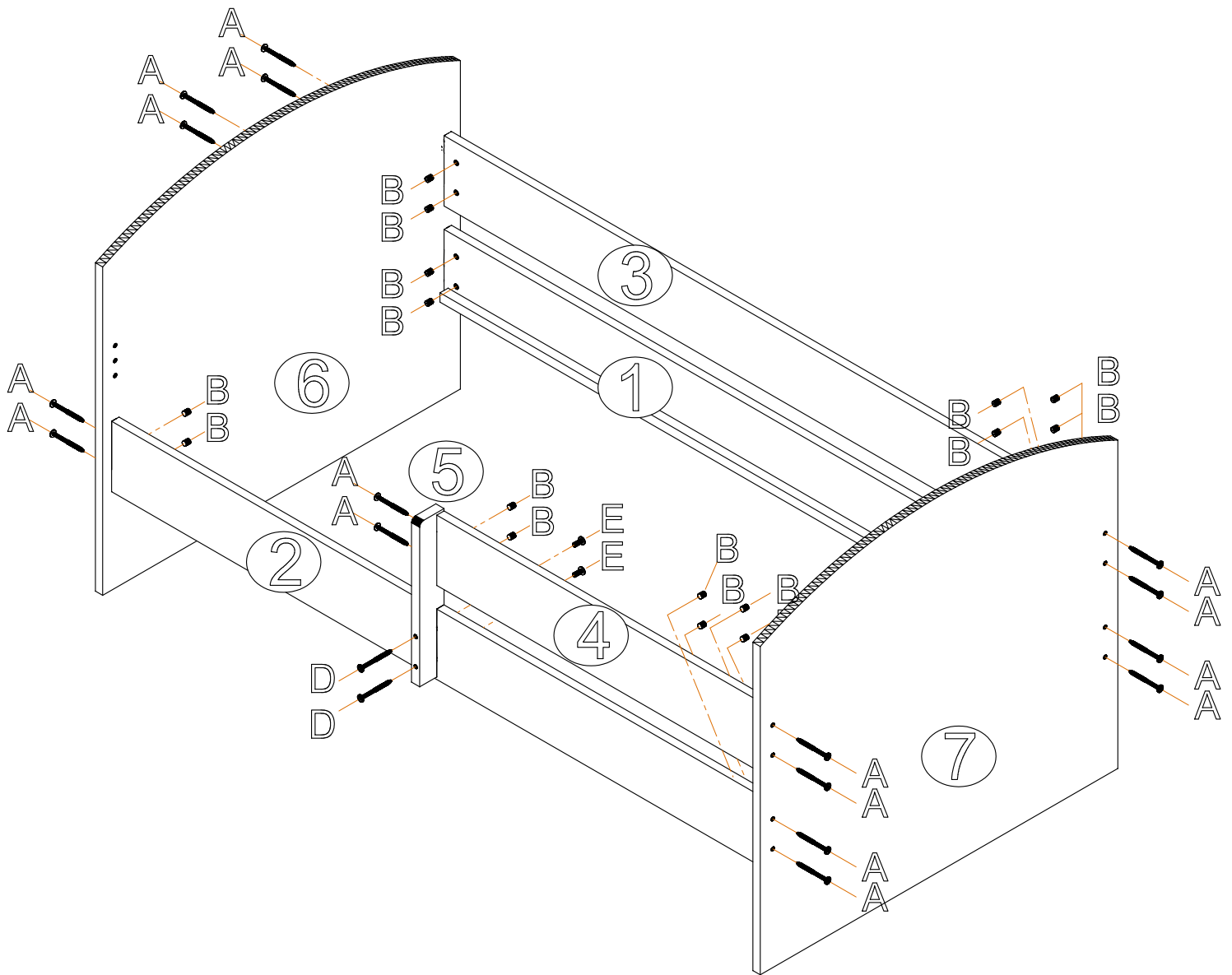



C		Φ8*30	8
---	---	-------	---

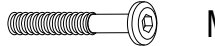

A		M6*70	16
B			16

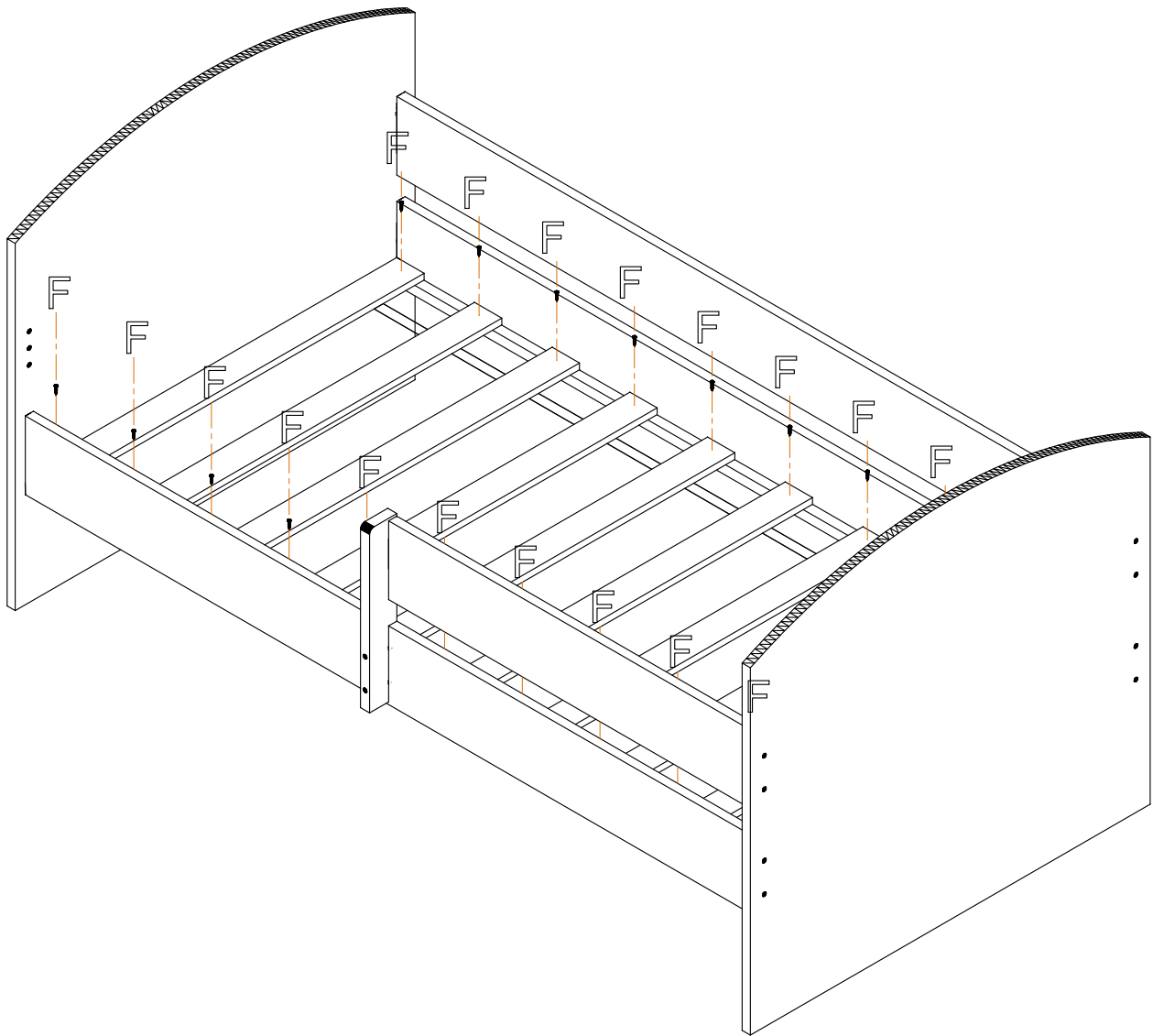
D		M6*50	2
E		M6*20	2



F		4*30	20
---	---	------	----