

# Alain

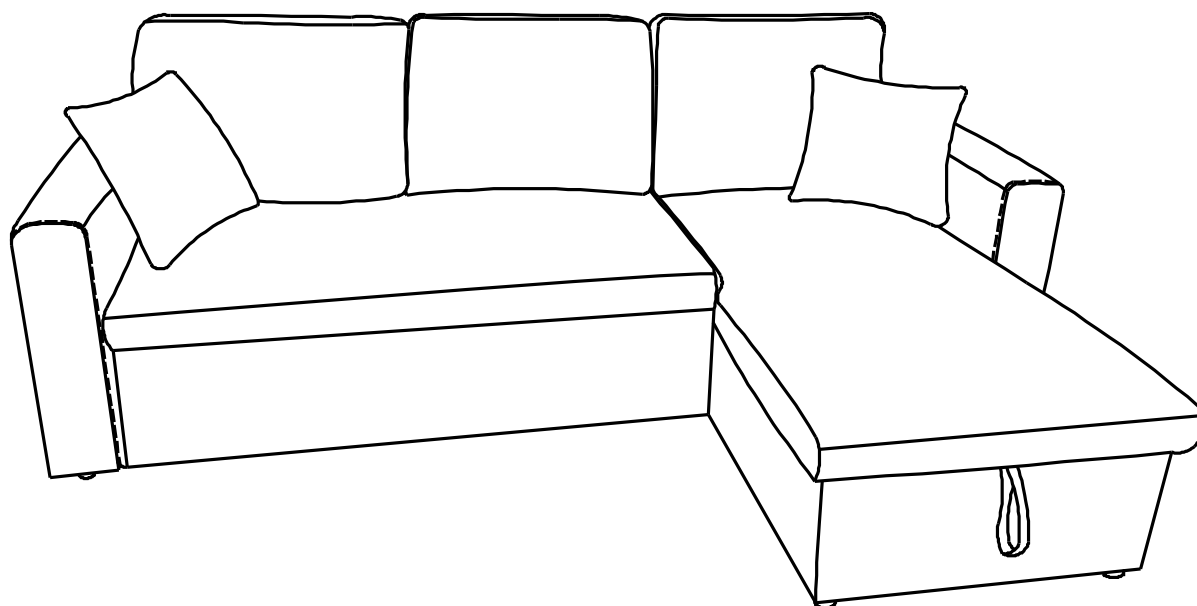



1424\_101418 / 101419 / 103034 / 103035 / 103036

103037 / 103038 / 103039

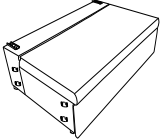
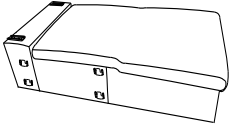
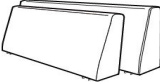
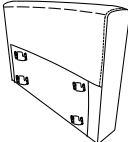
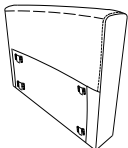

**h & j** Habitat  
et Jardin

# 1424\_101418 / 1424\_101419

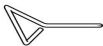
A		128*81*40.5CM	X1	1/3
B		145*71*40.5CM	X1	2/3
C		126*13*29CM 65*13*29CM	X2	2/3
D		81*14*57.5CM	X1	3/3
E		81*14*57.5CM	X1	3/3
F		60*45CM	X3	1/3 & 2/3
G		38*38CM	X2	2/3
H		H:2.5CM	X4	2/3
I		4CM	X4	2/3
J		9CM	X1	2/3

FR : SAV/INFORMATION /VIDEO/CONTACT

EN: AFTER-SALES SERVICE//INFORMATION/VIDEO/CONTACT

DE : REPARATUR-SERVICE UND ERSATZTEILE //INFORMATIONEN /VIDEO/KONTAKT

ES: SERVICIO POST-VENTA/INFORMACIÓN/VIDEO/CONTACTO

IT: SERVIZIO ASSISTENZA/INFORMAZIONI/VIDEO/CONTATTO

PT: SERVIÇO PÓS-VENDA/INFORMAÇÕES/VIDEO/CONTATO

PL: SERWIS TECHNICZNY//INFORMACJE/WIDEO/KONTAKT

NE: AFTER SALES SERVICE//INFORMATIE/VIDEO/CONTACT

HE: מע רשקתל/ואדיווה/ עדימ/תוריקמו תוריש רחאל

SAV.HABITATETJARDIN.COM

1

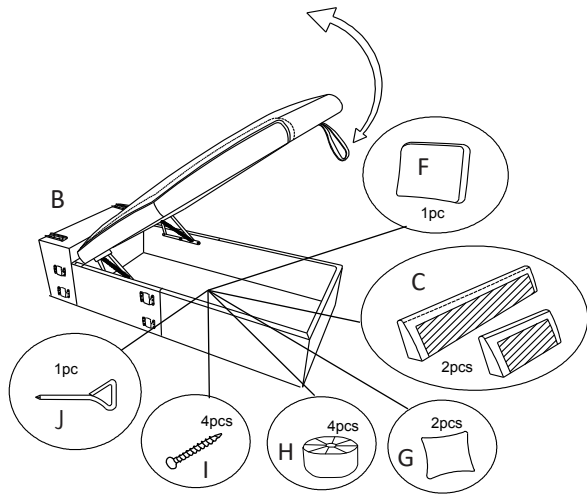

2

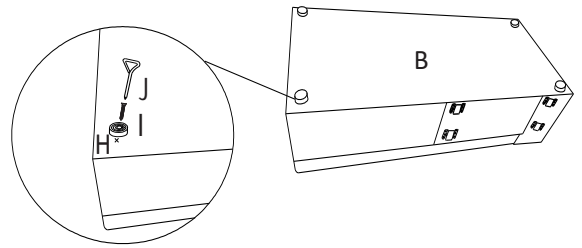

3

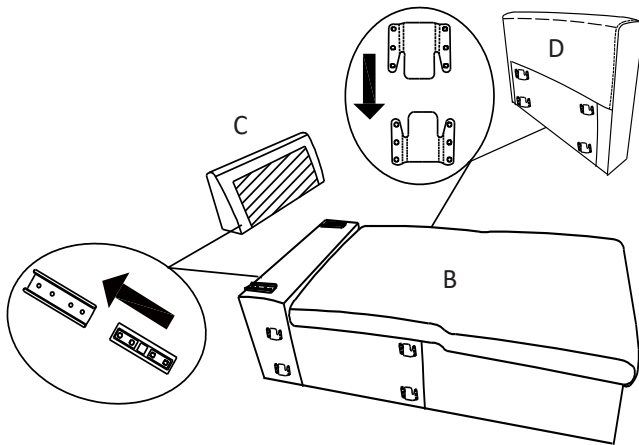

4

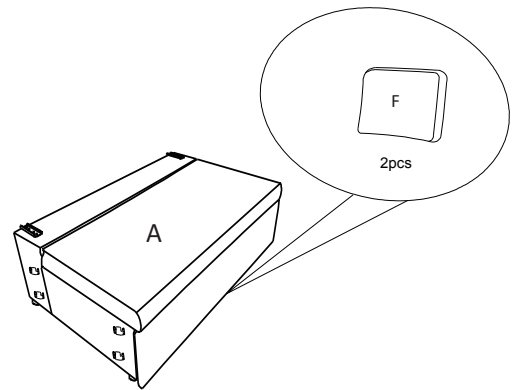

5

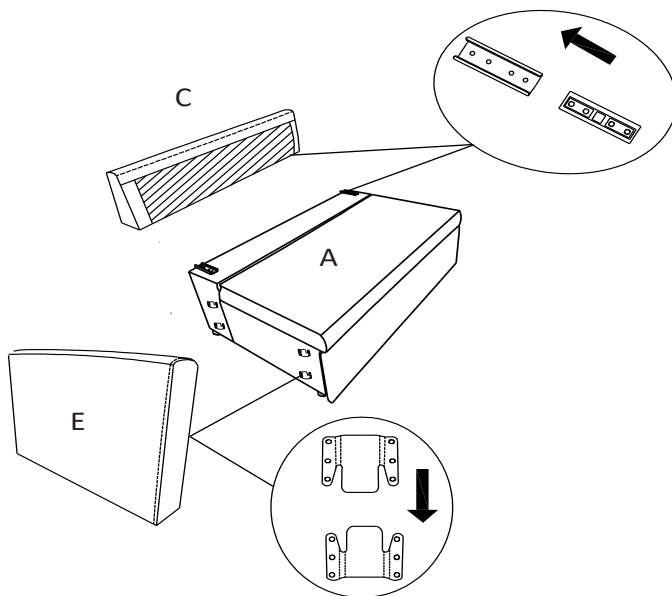

6

