

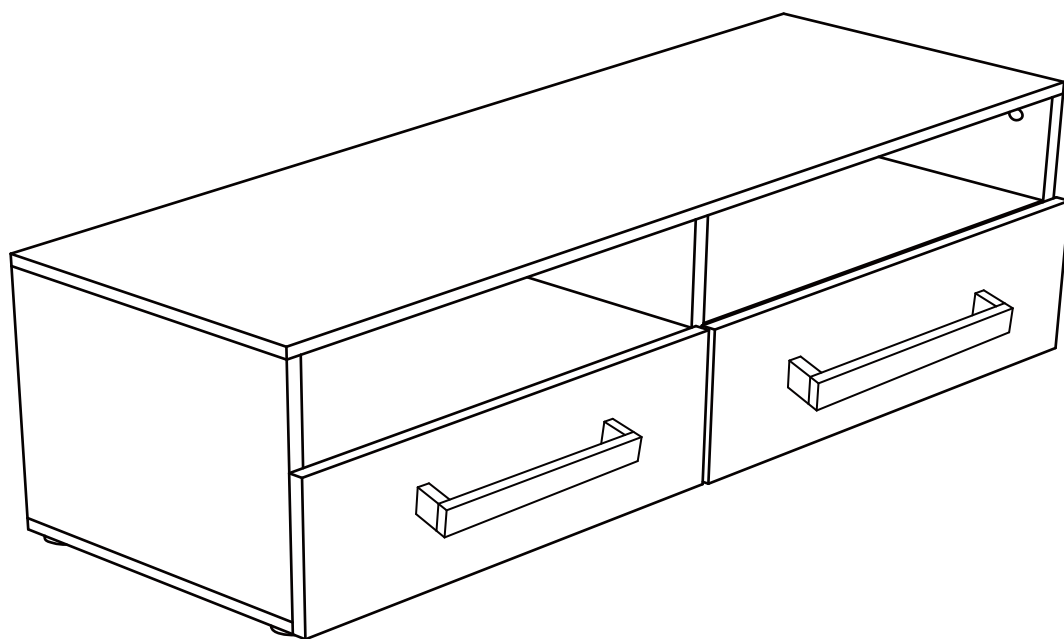





# IRMA

1417\_100095/100096/100097/100098

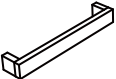
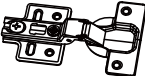
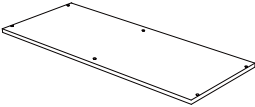
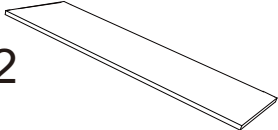
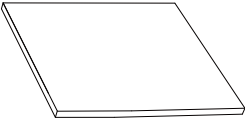
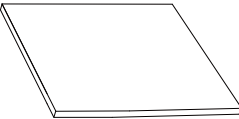
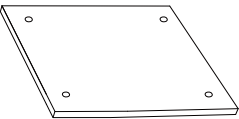
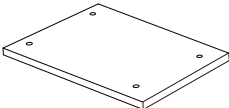
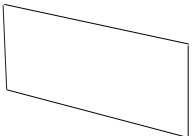

# 1417\_100095/100096/100097/100098

A	 x20	1/1	B	 x20	1/1
C	 x28	1/1	D	 x4	1/1
E	 x2	1/1	F	 x4	1/1
1	 x1	1/1	2	 x1	1/1
3	 x1	1/1	4	 x1	1/1
5	 x1	1/1	6	 x2	1/1
7	 x2	1/1	8	 x2	1/1

FR : SAV/INFORMATION /VIDEO/CONTACT

EN: AFTER-SALES SERVICE/INFORMATION/VIDEO/CONTACT

DE : REPARATUR-SERVICE UND ERSATZTEILE /INFORMATIONEN /VIDEO/KONTAKT

ES: SERVICIO POST-VENTA/INFORMACION/VIDEO/CONTACTO

IT: SERVIZIO ASSISTENZA/INFORMAZIONI/VIDEO/CONTATTO

PT: SERVIÇO PÓS-VENDA/INFORMAÇÕES/VIDEO/CONTATO

PL: SERWIS TECHNICZNY/INFORMACJE/WIDEO/KONTAKT

NE: AFTER SALES SERVICE/INFORMATIE/VIDEO/CONTACT

HE: סע רשקתל/וואדיווה/ עדימ/תוריקמו תוריש רחאל

**SAV.HABITATETJARDIN.COM**

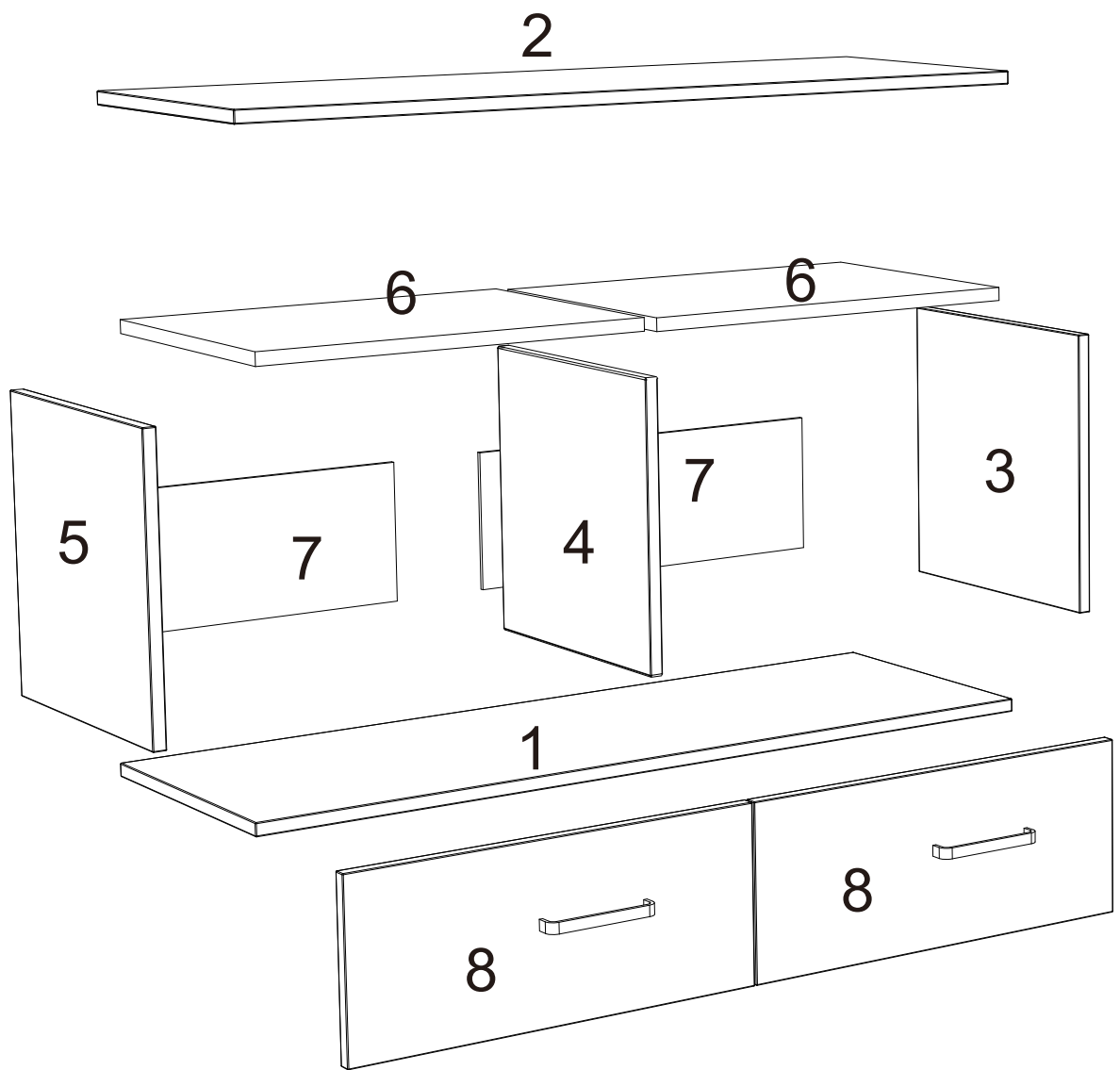

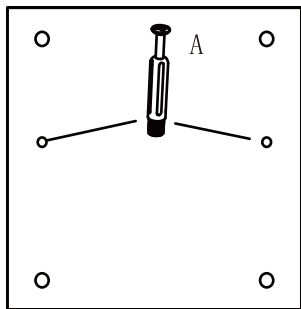

3, 4, 5

