

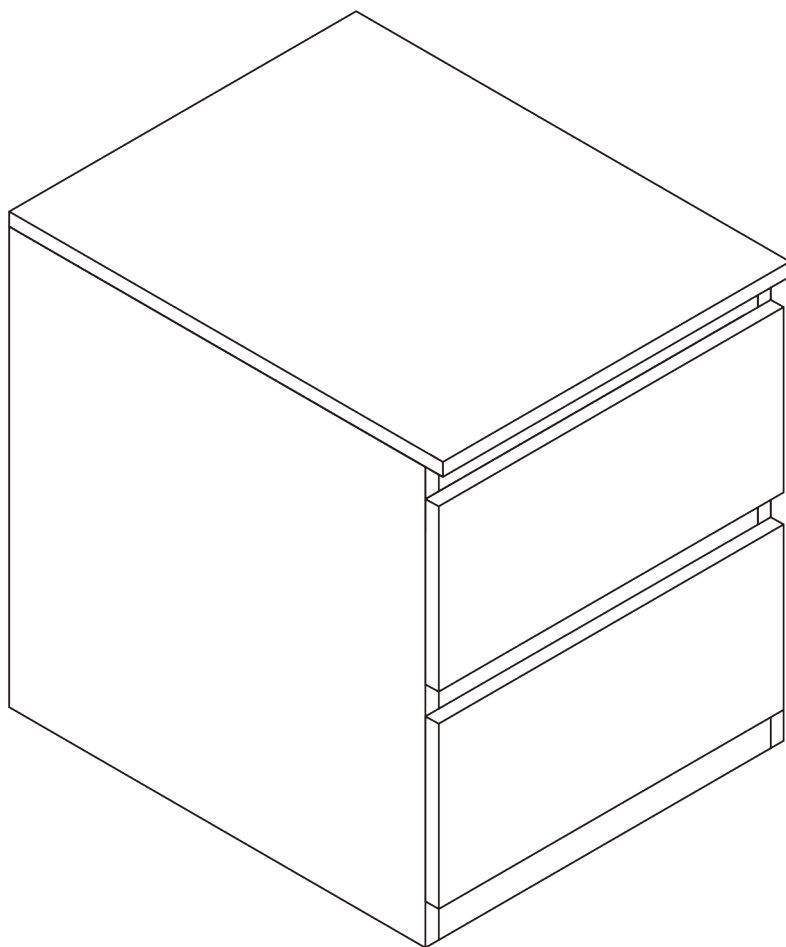









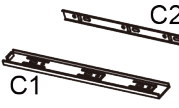

# TAMMY

1417\_102378/102379

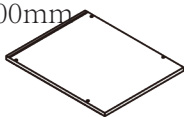

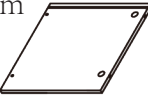
# 1417\_102378/102379

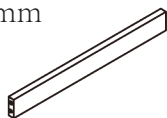
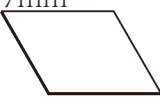
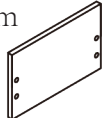
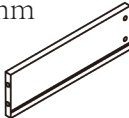
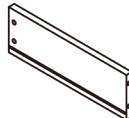
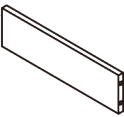
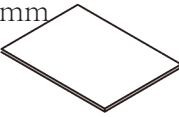
<b>A</b>  x12	1/1	<b>B</b>  x12	1/1
<b>C</b>  x2  C2	1/1	<b>E</b>  x16	1/1
<b>F</b>  x24  x1	1/1	<b>G</b>  x4	1/1
<b>L</b>  x24	1/1	<b>1</b>  500*400mm x1	1/1
<b>2</b>  480*480mm x1	1/1	<b>3</b>  480*480mm x1	1/1
<b>4</b>  368*64mm x1	1/1	<b>5</b>  368*64mm x3	1/1
<b>6</b>  424*377mm x1	1/1	<b>7</b>  398*186mm x1	1/1
<b>8</b>  400*80mm x2	1/1	<b>9</b>  400*80mm x2	1/1
<b>10</b>  312*80mm x2	1/1	<b>11</b>  321*393mm x2	1/1

FR : SAV/INFORMATION /VIDEO/CONTACT

EN: AFTER-SALES SERVICE/INFORMATION/VIDEO/CONTACT

DE : REPARATUR-SERVICE UND ERSATZTEILE /INFORMATIONEN /VIDEO/KONTAKT

ES: SERVICIO POST-VENTA/INFORMACION/VIDEO/CONTACTO

IT: SERVIZIO ASSISTENZA/INFORMAZIONI/VIDEO/CONTATTO

PT: SERVIÇO PÓS-VENDA/INFORMAÇÕES/VIDEO/CONTATO

PL: SERWIS TECHNICZNY/INFORMACJE/WIDEO/KONTAKT

NE: AFTER SALES SERVICE/INFORMATIE/VIDEO/CONTACT

HE: סע רשקתל/ואדיווה/ עדימ/תוריקמו תוריש רחאל

**SAV.HABITATETJARDIN.COM**

