

Bellini

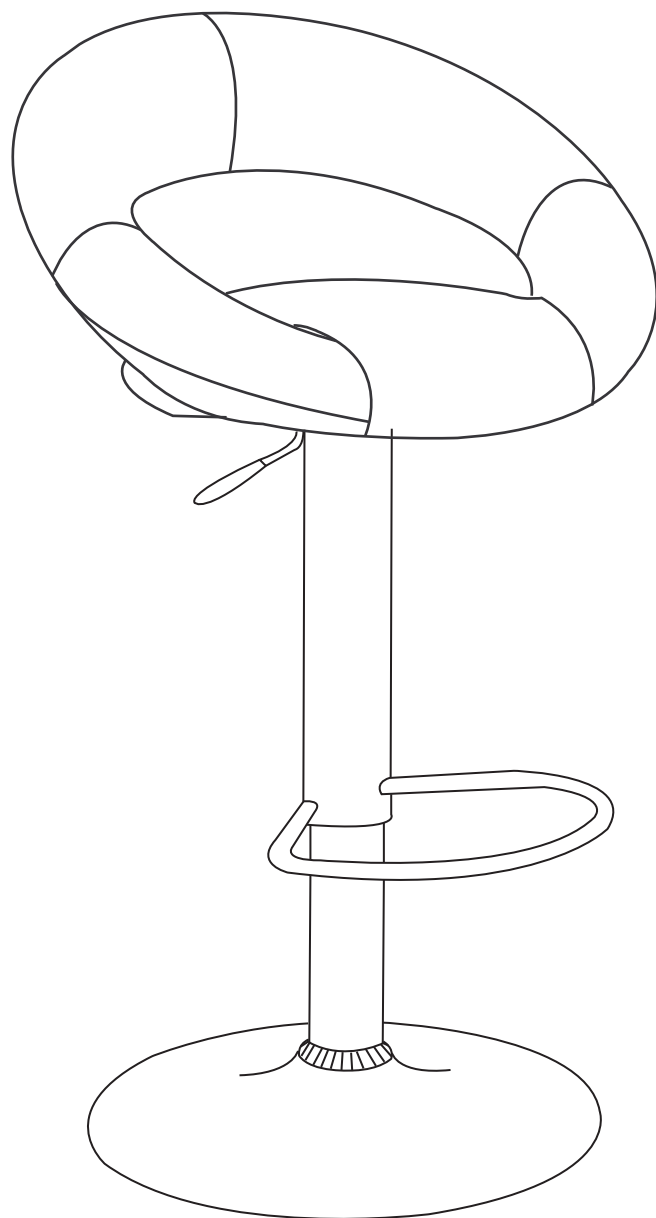



1409\_103401

1409\_103402

1409\_103403

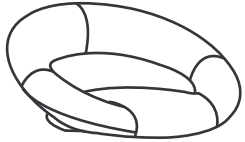
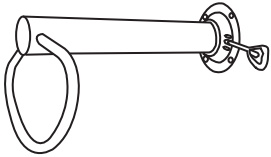

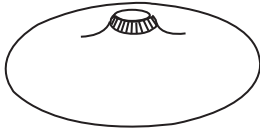
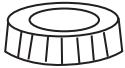
1409\_103401 / 1409\_103402 / 1409\_103403

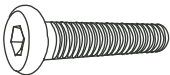
A		52x38x25CM	×1	2/1
B		29x17x38CM	×1	2/1
C		5x5x50CM	×1	2/1
D		38x38CM	×1	2/1
E		7.5x7.5×2CM	×1	2/1
F		M6	×1	2/1
G		M6×18MM	×4	2/1

FR : SAV/INFORMATION /VIDEO/CONTACT

EN: AFTER-SALES SERVICE/INFORMATION/VIDEO/CONTACT

DE : REPARATUR-SERVICE UND ERSATZTEILE /INFORMATIONEN /VIDEO/KON

ES: SERVICIO POST-VENTA/INFORMACIÓN/VIDEO/CONTACT

IT: SERVIZIO ASSISTENZA/INFORMAZIONI/VIDEO/CONTATTO

PT: SERVIÇO PÓS-VENDA/INFORMAÇÕES/VIDEO/CONTATO

PL: SERWIS TECHNICZNY/INFORMACJE/WIDEO/KONTAKT

NE: AFTER SALES SERVICE/INFORMATIE/VIDEO/CONTACT

HE: מע רשקתל/ואדיווה/ עדימ/תוריקמו תוריש רחאל

[SAV.HABITATETJARDIN.COM](http://SAV.HABITATETJARDIN.COM)

1

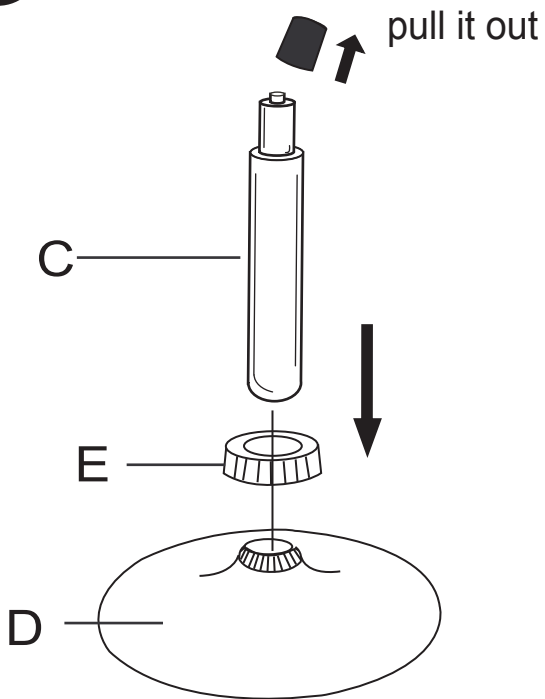

2

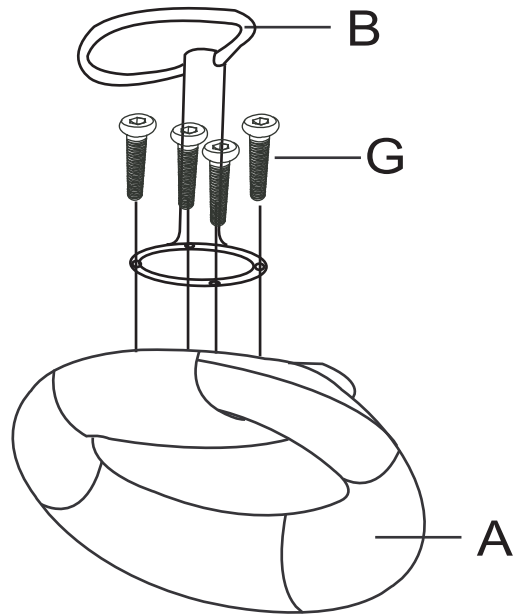

3

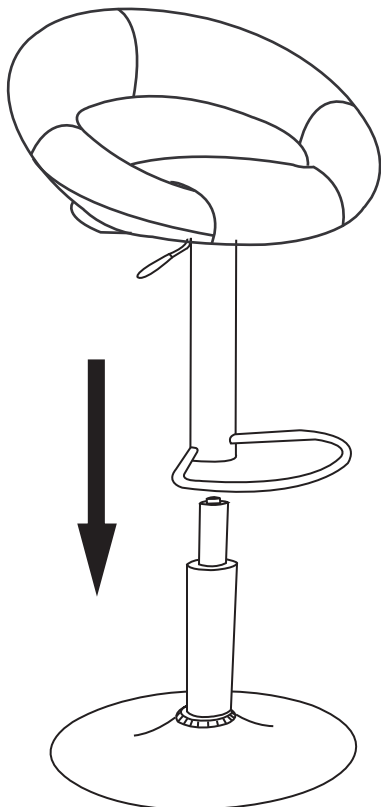

4

