

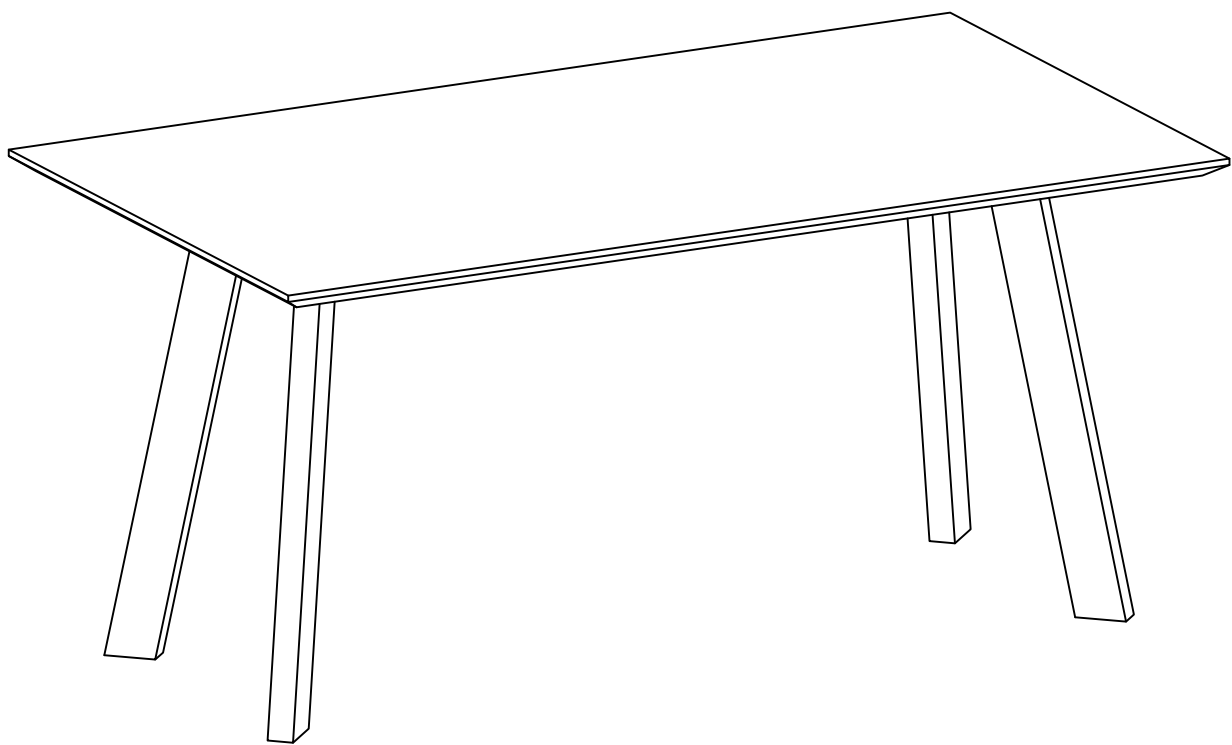



# Manhattan

1371\_99740

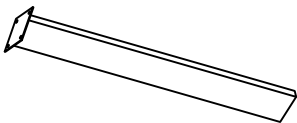
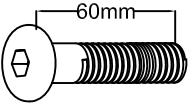
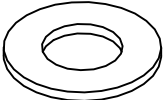
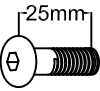

1371\_99740

A		1600x900x30mm	x1	1
B		1300x40x20mm	x2	1
C		880x90x80mm	x4	2
1		M8x60mm	x8	2
2		Ø8xØ16mm	x24	2
3		M8x25mm	x16	2
4		5#	x1	2

FR : SAV/INFORMATION /VIDEO/CONTACT

EN: AFTER-SALES SERVICE/INFORMATION/VIDEO/CONTACT

DE : REPARATUR-SERVICE UND ERSATZTEILE /INFORMATIONEN /VIDEO/KONTAKT

ES: SERVICIO POST-VENTA/INFORMACIÓN/VIDEO/CONTACTO

IT: SERVIZIO ASSISTENZA/INFORMAZIONI/VIDEO/CONTATTO

PT: SERVIÇO PÓS-VENDA/INFORMAÇÕES/VIDEO/CONTATO

PL: SERWIS TECHNICZNY/INFORMACJE/WIDEO/KONTAKT

NE: AFTER SALES SERVICE/INFORMATIE/VIDEO/CONTACT

ES: SERVICIO POST-VENTA/INFORMACIÓN/VIDEO/CONTACTO

HE: אחר שירות ומכירות/מידע /הווידאו/לתקשר עם

SAV.HABITATETJARDIN.COM

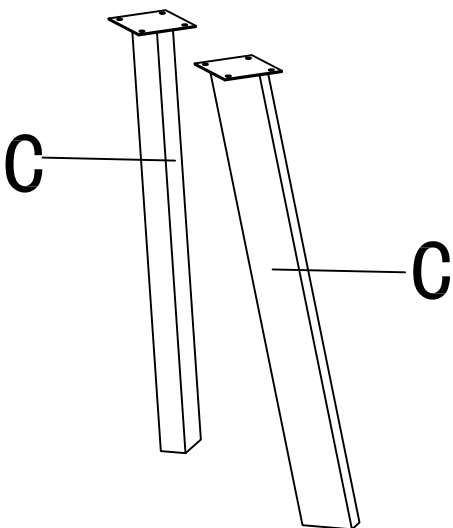
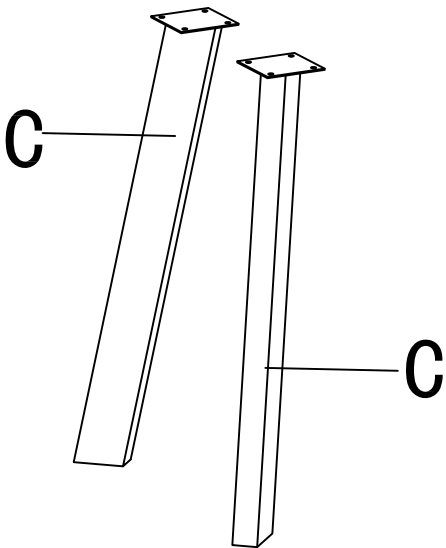
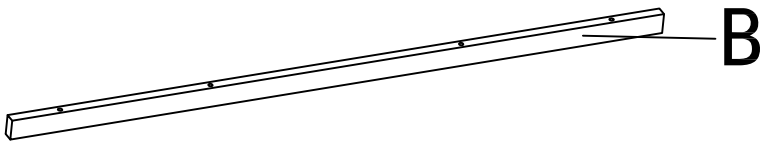
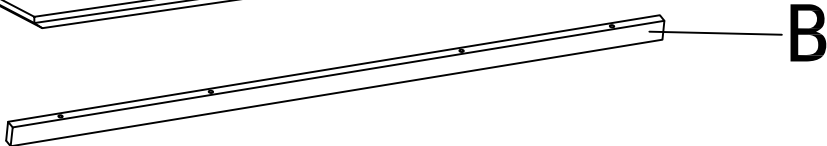
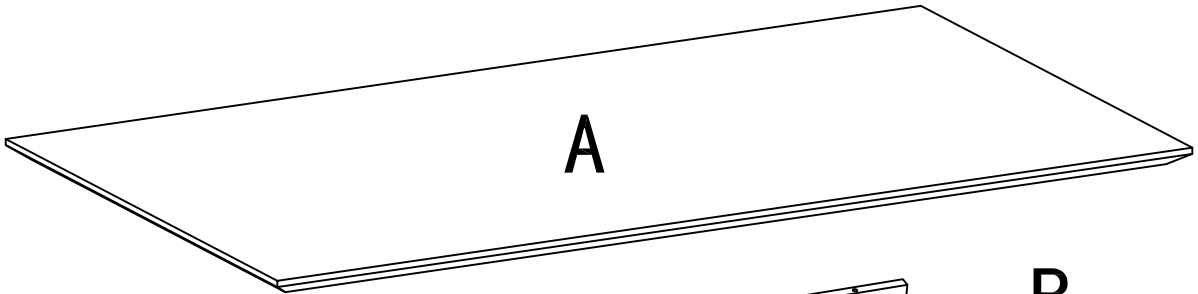

## FR

- Il est conseillé d'attendre d'avoir monté entièrement votre produit avant de serrer complètement vos vis.
- Pensez à fixer les pieds au sol. De même, en cas de vent fort, il est conseillé d'utiliser un kit d'encrage.
- Ce produit n'est pas fait pour la neige.

## EN

- It is advisable to wait until you have fully assembled your product before tightening your screws completely.
- Consider attaching the feet to the floor. Similarly, in case of strong wind, it is advisable to use a nail kit.
- This product is not made for snow.

## DE

- Es ist ratsam, für Ihre vollständig montiert zu warten, bevor vollständig Ihre Schrauben festziehen.
- Denken Sie daran, die Beine auf den Boden zu befestigen. In ähnlicher Weise bei starkem Wind, ist es ratsam, einen Tintensatz zu verwenden.
- Dieses Produkt ist nicht für den Schnee gemacht.

## ES

- Se aconseja montar totalmente el producto antes de apretar completamente todos los tornillos.
- Fije los pies al suelo. De igual manera, en caso de fuertes vientos, se aconseja utilizar un kit de anclaje.
- Este producto no está diseñado para la nieve.

## IT

- È consigliato di aspettare di avere montato interamente il prodotto prima di stringere completamente le viti.
- Pensate di fissare i piedi al suolo. In caso di vento forte, è consigliato di utilizzare un kit di ancoraggio.
- Questo prodotto non è fatto per la neve.

1

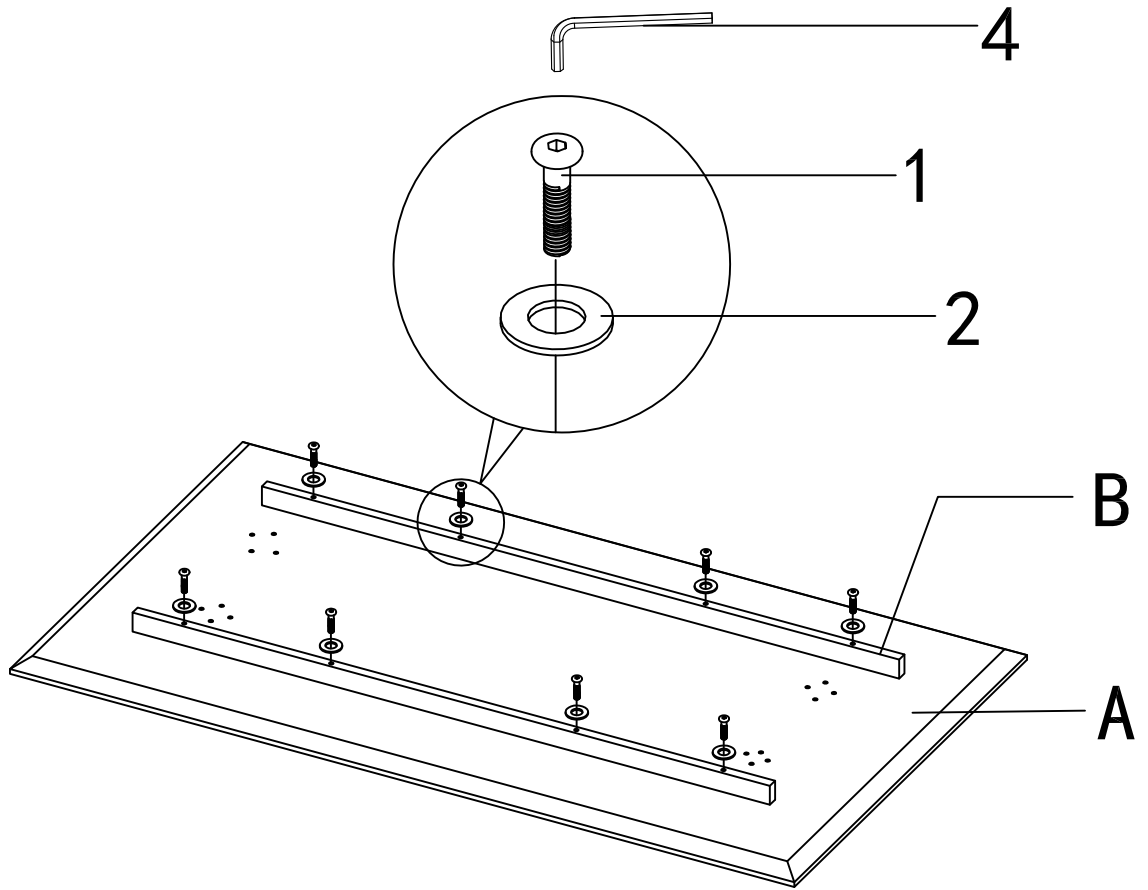

2

