

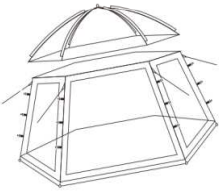



Tonnelle piscine

1298_80752

1298_80753

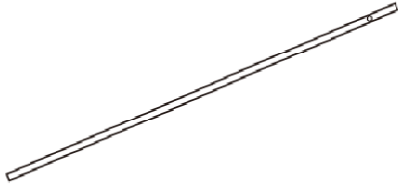

1298_80752		1298_80752		1298_80753	
1298_80753					
A		3800mm	4800mm	X1	1/1
B		740x230 x200mm	740x230 x230mm	X1	1/1
C		3980mm	5120mm	X3	1/1
D		1950mm		X6	1/1
E		220mm		X18	1/1
S1		3000mm		X6	1/1

FR : SAV/INFORMATION /VIDEO/CONTACT

EN: AFTER-SALES SERVICE/INFORMATION/VIDEO/CONTACT

DE : REPARATUR-SERVICE UND ERSATZTEILE /INFORMATIONEN /VIDEO/KONTAKT

ES: SERVICIO POST-VENTA/INFORMACIÓN/VIDEO/CONTACTO

IT: SERVIZIO ASSISTENZA/INFORMAZIONI/VIDEO/CONTATTO

PT: SERVIÇO PÓS-VENDA/INFORMAÇÕES/VIDEO/CONTATO

PL: SERWIS TECHNICZNY/INFORMACJE/WIDEO/KONTAKT

NE: AFTER SALES SERVICE/INFORMATIE/VIDEO/CONTACT

HE: עם לתקשר/הווידיאו/ מידע/ומכירות שירות לאחר

SAV.HABITATETJARDIN.COM

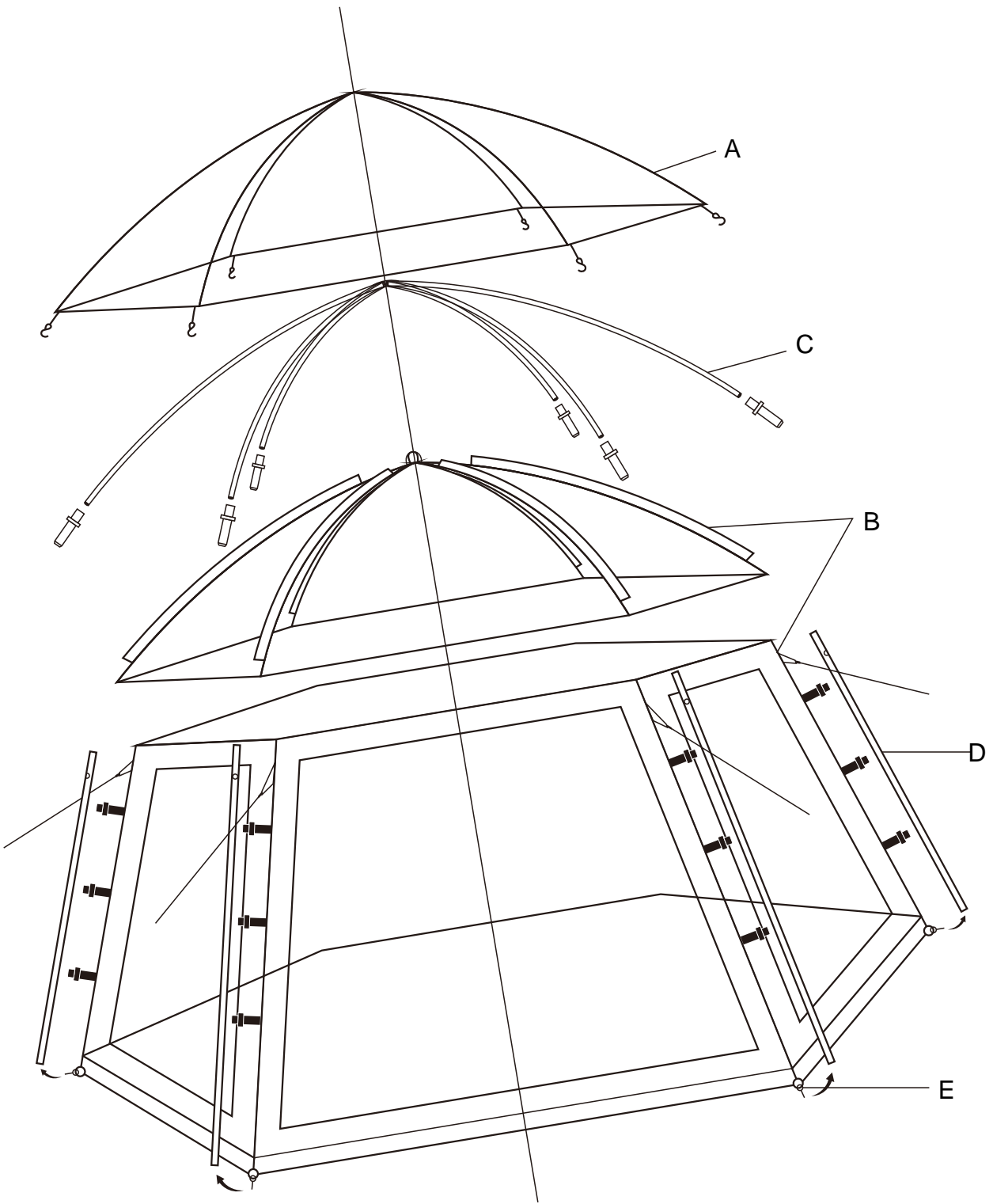

EN



This concerns your safety and your health! Please read these Operating Instructions and the Safety Instructions carefully prior to using the article for the first time.

Do not allow the folding rods to get into the hands of children. The individual segments of the rods are contracted by a rubber strap. Children may easily get their fingers caught in there.

Be careful when erecting the pool cover. The rods are under tension. When you slide the pin into the rods, take care not to get your fingers caught in them. It is best that two persons work together when the pool cover is erected, on account of the size of the pool cover.



Delivery, Figure A –F

A Tarpaulin

B Cover for roof

C Steel poles

D Fibreglass poles

E Nail pegs

F Guy lines



Repair

Repair small leakages at the seams by means of seam sealant and at the pool cover fabric by means of impregnation spray.

You can repair small holes or tears in the fabric by means of a suitable repair set for nylon/polyester fabric.



Cleaning

Use the usual commercial means of care for polyester fabric for the cleaning of the pool cover.

Do not wash the pool cover in the washing machine.

Do not have the pool cover cleaned by the dry-cleaner.



Mounting, Figure 1 – 17



ATTENTION!

The rooftop of the pool has to be removed by sudden growth of intense winds or storms. It is not designed for these weather conditions.

The attached storm tensioning in the scope of delivery provides only limited protection. Strong wind or storm damage is excluded from warranty or guarantee claims.

Dismantling

Dismantling is carried out in the reverse order of assembly.

Packing and storing

Pack the components of the pool cover in a dry and clean condition to avoid the creation of mould. Allow the parts to dry thoroughly if they have become wet during use.

Store the parts of the pool cover at a dry place. The fabric, the rods and zipper may be attacked by mould or corrosion if stored in a wet condition.



When you are working with rods in general: When joining the components of the rods, take care that your fingers will not be caught in them.

Fibre glass rods: The individual rods are under tension when you insert them into the second metal eye. Take care that they do not spring out of your hand you might get hurt.

Erection rods: One of the ends of the erection rods is pointed. Take care that you do not hurt your eyes.

UV Light: Please note that colour differences may arise due to exposure to sunshine (UV light). The product is only suitable for use during the swimming season, and should be dismantled and stored appropriately afterwards.

FR



Il est impératif de lire ce mode d'emploi et ces consignes de sécurité avant de monter la pool cover pour la première fois.

Il y va de votre santé et de votre sécurité!

Ne pas laisser les enfants jouer avec les mâts pliants. Leurs différents éléments sont retenus par un élastique, et les enfants pourraient se pincer les doigts.

Faire attention en relevant la pool cover, car les mâts sont alors soumis à des efforts.

Prendre également garde à ne pas se pincer les doigts en insérant l'extrémité des mâts dans les crochets sur anneaux.

Du fait de la taille de la pool cover, il est recommandé de la monter à deux.



Livraison, Figure A -F

A Tissu

B Couverture de toit

C Mâts de relevé en acier

D Mâts en fibre de verre noir

E Piquets

F Cordelettes avec tendeurs



Réparation

Encas de fuite minime, passer de l'isolant sur les coutures ou pulvériser du produit imprégnant sur la toile.

Utiliser un kit de réparation pour nylon et polyester s'ils s'avèrent nécessaire de réparer de petites trous ou des déchirures.



Nettoyage

Nettoyer le pavillon avec des produits usuels pour tissu en polyester. Le pavillon ne doit pas être lavé en machine, ni nettoyé à sec.



Le montage, Figure 1 - 17



ATTENTION!

Le toit de la piscine doit être enlevé en cas de vent fort ou de mauvais temps. Le toit de la piscine n'est pas adapté à ces conditions météorologiques.

Le hauban contre la tempête compris dans la livraison n'offre qu'une protection limitée. Un vent fort ou des dégâts causés par une tempête sont exclus dans le cadre des droits à la garantie.

Le démontage

Le démontage s'effectue dans l'ordre inverse du montage.

Stockage

Tous les composants de la pool cover doivent être propres et secs lors du démontage afin d'éviter la formation de moisissure. Si la tente est humide lors du démontage, il est nécessaire de la faire sécher avant de la stocker.

Entreposer la tente dans un endroit sec afin d'éviter la moisissure du tissu et la rouille des éléments métalliques.



Mâts en général: lors du montage, prendre garde à ne pas se pincer les doigts.

Mâts en fibre de verre: les mâts en fibre de verre sont soumis à des efforts lorsque leur seconde extrémité est introduite dans le second oeillet métallique (risqué d'accident).

Mâts de portes / auvents: une de leurs extrémités est pointue (danger pour les yeux).

Lumière UV : Veuillez noter qu'en raison du rayonnement solaire (UV), les couleurs peuvent subir des altérations.

L'article est seulement approprié pour l'utilisation pendant la saison des baignades. Ensuite, il doit être démonté et entreposé de façon adéquate.

ES



¡Se trata de su seguridad y de su salud! Es imprescindible que lea este manual de instrucciones y las indicaciones de seguridad antes del primer uso.

La construcción no debe caer en manos de niños. Las piezas individuales de la construcción son agrupadas por una cinta de goma. Los niños podrían dañarse las manos en ella. Preste atención cuando ponga en pie el techo solar. La construcción está sometida a tensión.

El montaje debe ser realizado por dos personas.



Volumen de suministro, Figura A - F

A Techo, incluidas las paredes laterales

B Cubierta para el techo

C Barras de acero

D Barras de fibra de vidrio

E Anclaje para tierra

F Tensado anti-tormenta



Reparación

Los pequeños problemas de falta de estanqueidad se solucionan en las costuras con sellante para costuras y en el tejido de la lona con aerosol de impregnación. Los pequeños agujeros o fisuras en el tejido de nailon se pueden reparar con un kit de reparación para nailon/poliéster.



Limpieza

Utilice los productos de limpieza habituales en el mercado para poliéster. No lave el techo en la lavadora. No encomiende la limpieza del techo a una tintorería de tratamientos químicos.



Desmontaje, figuras 1-17



¡ADVERTENCIA!

El techo para piscinas tiene que ser desmontado cuando haya viento fuerte o tormenta. El techo para piscinas no ha sido diseñado para soportar esas inclemencias.

El anclaje contra tormenta adjunto ofrece solo una protección limitada. Los daños ocasionados por viento fuerte o por tormentas no los cubre la garantía.

Desmontaje

El desmontaje se efectúa en el orden inverso al montaje.

Embalaje y almacenamiento

Embale las piezas secas y limpias, para que no se pueda cubrir de moho. Si algunas piezas estuviesen húmedas déjelas secar por completo.

Guarde su techo para piscina en un lugar seco. El tejido, las barras y las cremalleras pueden cubrirse de moho u oxidarse.



Generalidades sobre la construcción: Cuando ensamble las piezas preste atención a no pillarse los dedos.

Barras de fibra de vidrio: Las piezas individuales están sometidas a tensión cuando son introducidas en las dos argollas metálicas. Tenga cuidado que las barras no se le escapen de la mano. Podría lesionarse.

Luz UV: Tenga en cuenta que la radiación solar (luz UV) puede cambiar el color. El artículo sólo es apto para ser usado durante la temporada de baño y al finalizar esta debe ser desmontado y almacenado.

A

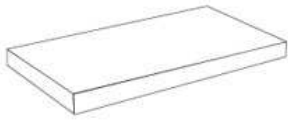

B

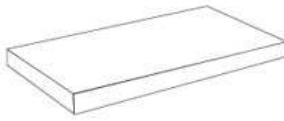

C



D



E



F



01

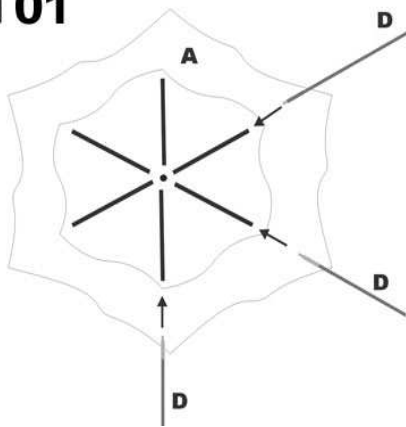

02

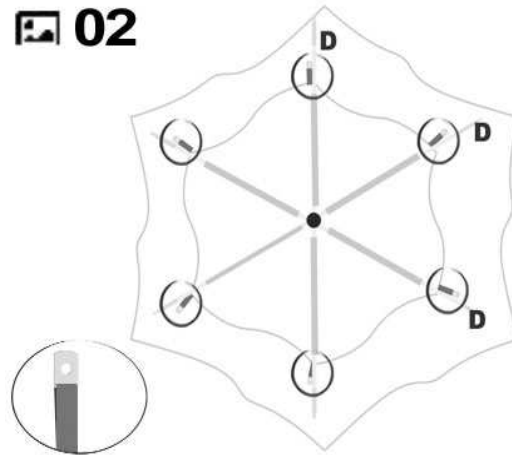

03

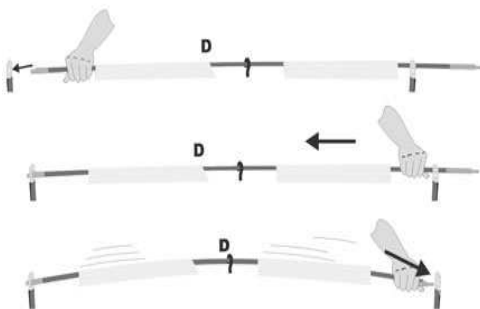

04



05



06

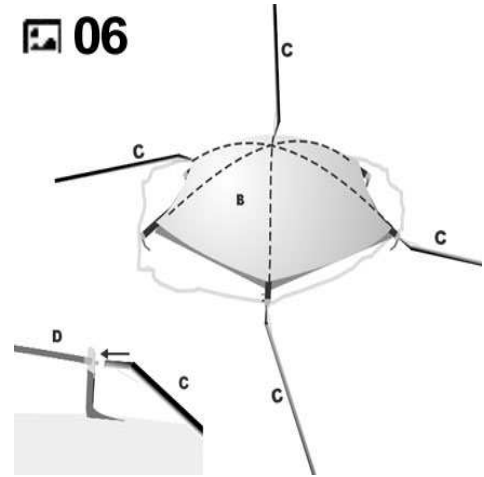

07

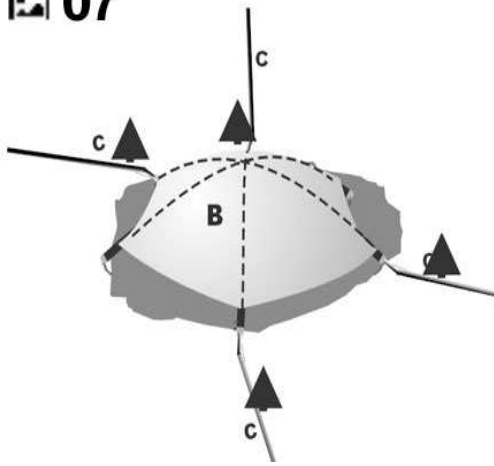

08

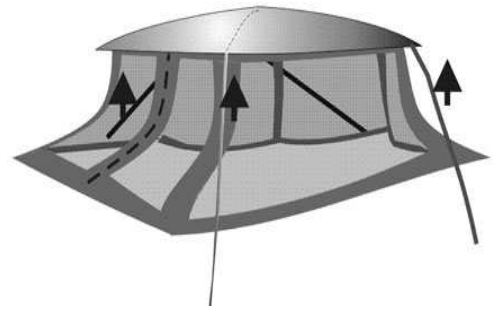

09



10



11

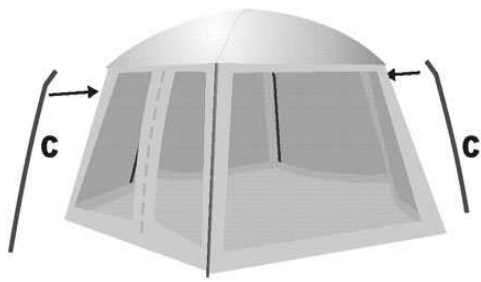

12

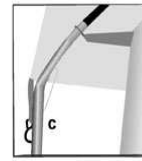
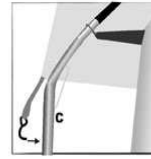

13

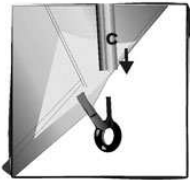

14



15

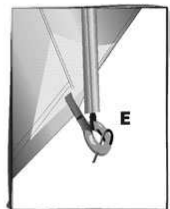
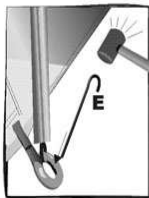

16

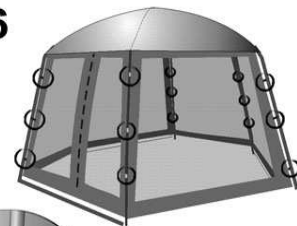

17

