

Mano
1293_100129



h&j Habitat
et Jardin

Year 2019
Page 1 of 51









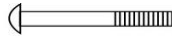
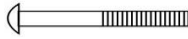

SAFETY NOTES















To prevent damage and accidents to persons and/or property, the following instructions and advice must be followed:











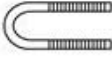

1. Thoroughly read all parts of this manual and strictly follow the instructions before using.
2. Do not use any accessories other than those provided and /or specified by the manufacturer.
3. Not suitable for children under 3 years.
4. This equipment must be assembled and checked by an adult.
5. Please retain complete instructions for future reference.
6. "Warning. For domestic and outdoor use only."
7. Check all nuts and bolts for tightness and tighten when required.
8. Check all coverings and bolts for sharp edges and replace when required.
9. Place this equipment on a level surface at least 2 meters from any structure or obstruction. Such as a fence, garage, house, overhanging branches, laundry line or electrical wires.
10. Other persons must never be allowed to stand within the range of action of the equipment when in use.
11. DO NOT install this equipment over concrete, asphalt or any other hard surface.
12. Leave all fittings finger tight until assembly is complete (for ease of construction)- then tighten firmly.
13. Always supervise young children at play, until they are physically competent and confident.
14. This item is not designed for adults or combined weight of 5 children not to exceed a maximum weight of 175kgs. (35 kgs for each element)
15. DO NOT allow children to stand on the glider or seats and over load in one play element.
16. DO NOT allow children to get off the glider or seats until it has stopped moving.
17. DO NOT allow loose, baggy (or hooded) clothes to be worn, since children can get trapped and may be unable to free themselves.
18. DO NOT allow children to climb on parts on this equipment not intended for this purpose.
19. Regularly check the item for wear and damage, removing the item from use when necessary until replacement parts are fitted.
20. Please remove all packaging including shrunk-on film, polybag, carton, pallet, ...ect. before giving to a child.
21. This product is for home use only and has not been designed for commercial use in play fitness centers, nurseries, etc.
22. Failure to assemble this item as per the instruction may cause injury to the user.
23. Please keep these instruction in a safe place for future reference.
24. Age suitability: 3-10 years.
25. Do not put your hand near moving parts.



Assembly Instructions

PARTS LIST

1293_100129			
Ref	Description	Qty	Illustration
A	M6 50mm bolt	6	
B	M6 55mm bolt	4	
C	M6 35mm bolt	14	
E	M6 65mm bolt	4	
F	M8 88mm bolt	2	
G	M8 60mm bolt	9	
H	M8 45mm bolt	6	
I	M8 65mm bolt	4	
J	M6 washer	58	
K	M8 washer	39	
L	M6 spring washer	28	
M	M8 spring washer	29	

Ref	Description	Qty	Illustraion
N	Wave waher	4	
O	M6 Domenut	28	
P	M8 Domenut	29	
Q	M8 nut for U-bolt	8	
R	Ground anchor	4	
S	Top bar	2	
T	Top leg	4	
U	Bottom leg	4	
V	Glider handle tube	2	
W	Side stay bar	2	
X	Lower glider leg	2	
Y	Glider seat tube	2	
Z	Glider bracket	3	
AA	Glider seat	2	
BB	Glider footrest	2	

Ref	Description	Qty	Illustraion
CC	Swing seat	2	
DD	Plastic bearing	16	
EE	U bolt	4	
FF	Sexy bolt for footrest / lawn swing seat panel	26	
GG	Clamp	2	
II	Spanner	1	
JJ	Spanner	1	
KK	Lawn swing seat panel	6	
LL	Hand rail tube	4	
MM1	Plastic cap for 50.8mm pole	2	
MM2	Plastic cap for 45mm pole	2	
MM	Floor support tube with V-Clip	2	
NN	Middle tube	4	

Ref	Description	Qty	Illustraion
NN1	Seat back tube	4	
NN2	Seat tube	4	

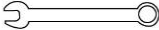
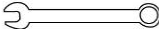
- Tools required :
1. "A-Frame" Ladder
 2. Philips head screw driver 
 3. Combination Wrench 10 
 4. Combination Wrench 13 

Assembly Steps:

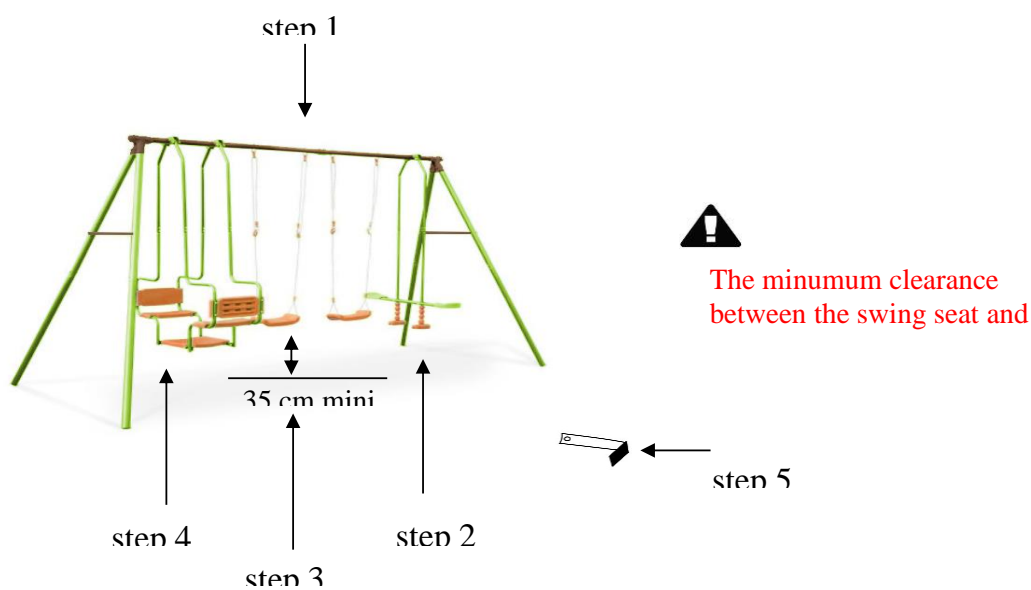

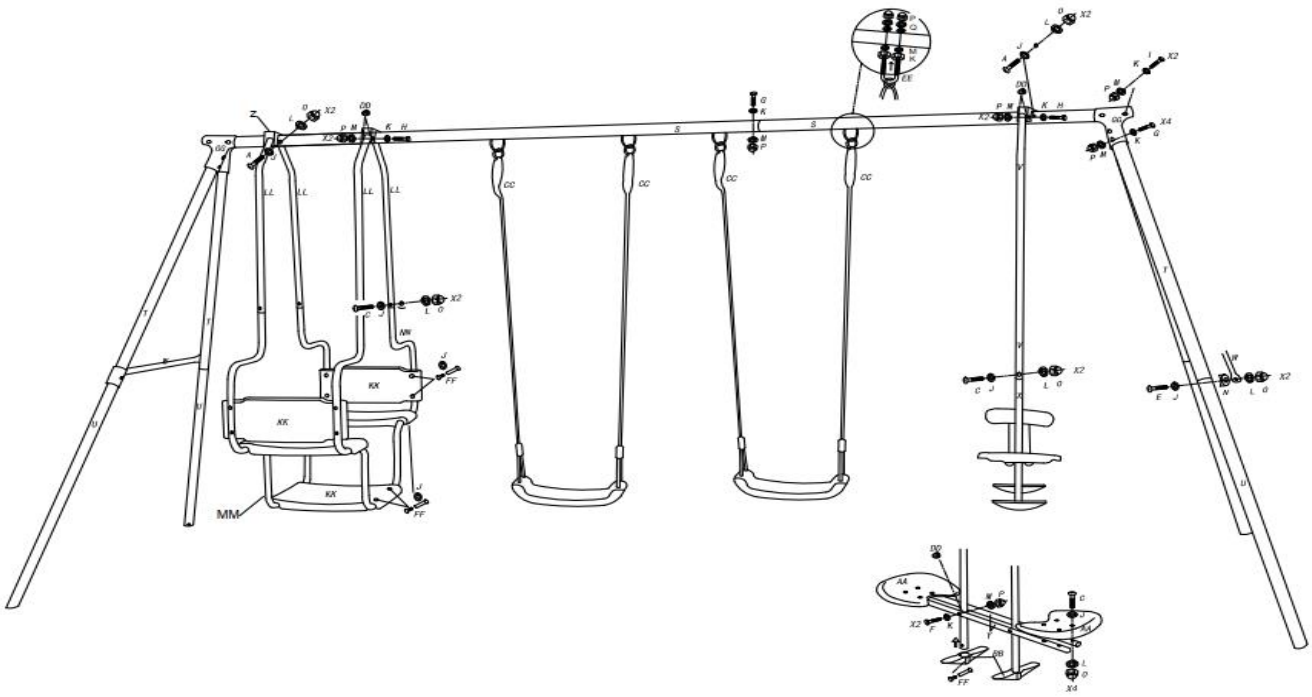

Step 1 Assembling The Frame

- 1.-1 Connect 2pcs top bar S, using bolt set (bolt Gx1 + washer Kx1 + spring washer Mx1 + domenuit Px1).
- 1.-2 Connect the top bar S, top leg T, and clamp (GG), using bolt set (bolt lx2 + washer Kx2 + spring washer Mx2 + domenuit Px2) on top bar and (bolt Gx4 + washer Kx4 + spring washer Mx4 + domenuit Px4) on top leg.
- 1.-3 Attach the side stay bar W to leg (T & U), using bolt set (bolt Ex2 + washer Jx2 + wave washer Nx2, spring washer Lx2 + domenuit Ox2)

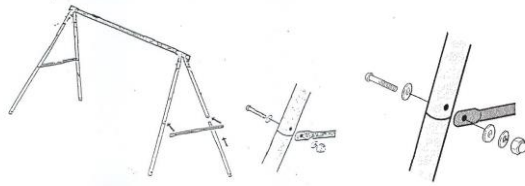

- 1.-4 Insert plastic cap (MM1) into both sides of top bar (S) & plastic cap (MM2) into leg (T)

Step 2 Assembling The Glider

- 2.-1 Combine glider bracket Z to top bar S. using bolt set (bolt Ax1 + washer Jx2 + spring washer Lx1 + domenuit Ox1).

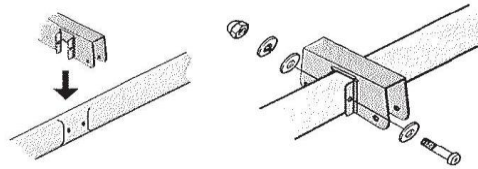

- 2.-2 Insert plastic bearing (DD) into both sides of the handle tube (V) and attach to glider bracket (Z), using bolt set (bolt Hx1 + washer Kx1 + spring washer Mx1 + domenuit Px1)

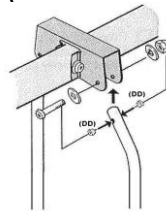

- 2.-3 Attach lower glider leg tube X to glider handle tube V using bolt set (bolt Cx1 + washer Jx1 + spring washer Lx1 + domenuit Ox1).

- 2.-4 Insert plastic bearing (DD) into both sides of the lower glider leg tube (X) and fix glider seat tube (Y), using bolt set (bolt Fx1 + washer Kx2 + spring washer Mx1 + dometut Px1).
To ensure the concavity side of glider set tube face down as below.
- 2.-5 Fix glider seat (AA) to glider seat tube (Y) using bolt set (bolt Cx1 + washer Jx1 + spring washer Lx1 + dometut Ox1.)
- 2.-6 Attach glider footrest (BB) to lower glider leg tube (X) using bolt set (bolt FFx1).

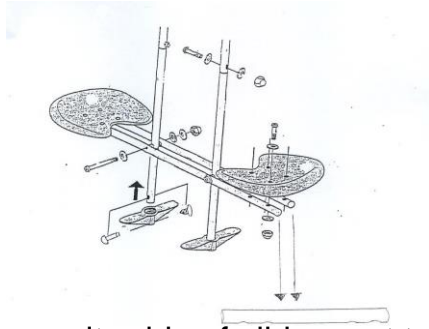

The concavity side of glider seat tube (Y) face down.

Step 3 Assembling The Swing Seat X 2

- 3.-1 Attach swing seat (CC) to top bar (S) using U bolt set (U bolt EEx1 + washer Kx4 + spring washer Mx2 + nut Qx2 + dometut Px2).

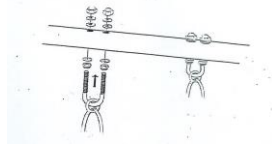

- 3.-2 Attach the other swing seat (CC) to top bar (S) using U bolt set (U bolt EEx1 + washer Kx4 + spring washer Mx2 + nut Qx2 + dometut Px2).

Step 4 Assembling The Lawn Swing

- 4.-1 Combine glider bracket Z to top bar S. using bolt set (bolt Ax1 + washer Jx2 + spring washer Lx1 + dometut Ox1).
Insert plastic bearing (DD) into both sides of the handrail tube (LL) and attach bracket (Z), using bolt set (bolt Hx1 + washer Kx1 + spring washer Mx1 + to dometut Px1)
- 4.-2 Insert floor support tube with V-clip (MM) into Seat tube (NN2)

- 4.-3 Attach lawn swing seat panel (KK) to middle tube (NN), Seat back tube (NN1) & Seat Tube (NN2) using bolt set(sexy bolt FF + washer Jx4).
- 4.-4 Put floor support tube (MM) under lawn swing seat panel (KK), fixing them by using bolt set (sexy bolt FF + washer Jx4).
Fix floor support tube (MM) to middle tube (NN) by using sexy bolt FF + washer Jx4
- 4.-5 Attach middle tube (NN) to handrail tube (LL), using bolt set (bolt Cx1 + washer Jx1 + spring washer Lx1 + domenut Ox1).

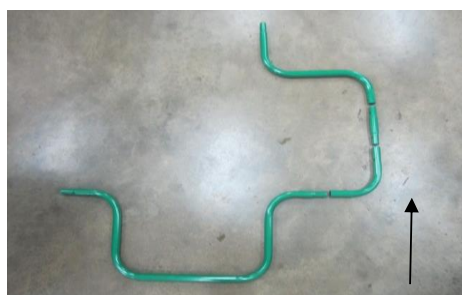

4.-2

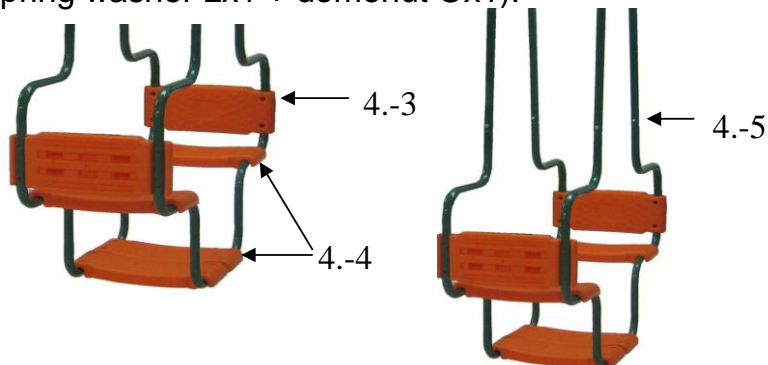

Step 5 Assembling The Gound Anchors

- 5.-1 Fix ground anchor R into bottom hole of each 4 leg, using bolt set (bolt Bx1 + washer Jx1 + spring washer Lx1 + domenut Ox1).
- 5.-2 Dig 40cm depth cave and put cement in size 35x35x30cm (LxWxH).
Take ground anchor R into cement when cement is soft.
- 5.-3 Make sure ground anchor R is well fixed into cement to prevent this product overturning. When cement is hard, cover the cave with soil.
- 5.-4 When selecting a place to install the equipment, take into account the space required for the training activity. Allowing a margin of at least 2 m on all sides. For this reason, avoid positioning the equipment near protruding elements, walls, treescape, etc.
- 5.-5 Once the equipment has been assembled, make sure that it is placed safely and completely stable, never on carpet (it must be perfectly stable, not least under conditions of maximum load).

- 5.-6 Do not install the equipment inside the sauna or any wet area. Because it may cause rusty.

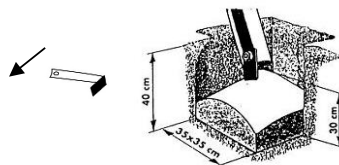

Care and Maintenance

1. This equipment must be assembled and checked by an adult.
2. Regularly check all nuts and bolts for tightness before use and replace any worn, defective or missing parts. **DO NOT** try to repair broken parts.
3. Regularly check swing seat, ropes, glider, steel tube, ground anchor and other parts are tightened completely and replace worn & damaged parts when necessary. If these checks are not carried out, this equipment could overturn or otherwise become a hazard.
4. Remove worn and damaged parts from use when necessary until replacement parts are fitted.
5. Replace defective parts in accordance with the manufacturer's instructions.
6. At the beginning of each season, please oil all metallic move parts to maintain and regularly oil when necessary during the usage season.
7. Swing and Glider set placement:
 - (a) Place this equipment on a level surface at least 2 meters from any structure or obstruction. Such as a fence, garage, house, overhanging branches, laundry line or electrical wires.
 - (b) **DO not** install this equipment over concrete, asphalt or any other hard surface.
 - (c) Place this equipment on a well-lighted area.
 - (d) Do not use indoor.
8. Weather condition:
 - (a) Glider seat, footrest and swing seat should be kept dry--do not use when these parts are wet.
 - (b) Wind or air movement shall be calm and gentle.
 - (c) Please do not use when face sun directly to affect visibility or change orientation to leave sun behind.
9. This item is not designed for adults or combined weight of 5 children not to exceed a maximum weight of 175kgs. (35 kgs for each element)
10. Please keep these instruction in a safe place for future reference.
11. To keep clean of this equipment.











NOTES DE SECURITE

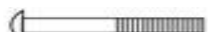













Afin d'éviter le dommage ou accidents aux personnes et/ou la propriété, il faut respecter les instructions et suggestions suivantes:











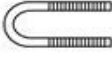
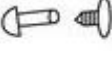

1. Lisez minutieusement les parts de ce manuel et respectez les instructions avant l'utilisation.
2. N'utilisez aucuns accessoires sauf ceux-là fournis et/ou spécifiés par le fabricant.
3. Le produit ne peut pas être utilisé par l'enfant inférieur à 3 ans.
4. Cet équipement doit être assemblé et examiné par un adulte.
5. Veuillez garder bien les instructions complètes pour une référence future.
6. "Avertissement : Seulement pour l'utilisation domestique et extérieure."
7. Vérifiez tous les écrous et vis pour une bonne fixation et les serrez si nécessaire.
8. Vérifiez les bordures aiguës de toutes les couvertures et les vis et les remplacez si nécessaire.
9. Posez cet équipement sur un plan horizontal au minimum 2 mètres à aucune structure ou obstruction. Par exemple, une clôture, garage, maison, branches en surplomb, ligne de linge ou câbles électriques.
10. Aucune personne n'est permise d'être debout dans l'étendue d'action de l'équipement lors de l'utilisation.
11. NE PAS installer cet équipement sur la surface dure telle qu'en béton, asphalte, etc.
12. Laissez tous les raccords serrés jusqu'à ce que l'assemblage soit terminé (pour faciliter la construction) - et puis les serrez fermement.
13. Supervisez toujours les enfants quand ils jouent jusqu'à ce qu'ils soient physiquement compétents et confiants.
14. Cet équipement n'est pas conçu pour les adultes ou le poids combiné de 5 enfants dont le poids maximal ne dépasse pas à un 175kgs. (35 kgs pour chaque élément)
15. NE PAS permettre aux enfants d'être debout sur la balancelle ou sièges et d'être surchargé dans une élément.
16. NE PAS permettre aux enfants de quitter la balancelle ou sièges jusqu'à ce que l'équipement ait stoppé.
17. NE PAS permettre aux enfants de porter les vêtements lâches, larges (ou à capuchon), parce que les enfants peuvent être piégés et incapables de se libérer.
18. NE PAS permettre aux enfants de monter sur les parties de cet équipement qui n'est pas destiné à ce but.
19. Vérifiez régulièrement le problème d l'usure et du dommage de l'équipement. Déplacez l'équipement pour ne pas être utilisé si nécessaire jusqu'à ce que les parties de remplacement soient montées.
20. Veuillez retirer tous les emballages, y compris le film rétréci, le sac plastique, le carton, la palette, etc. avant de donner à un enfant.
21. Le produit n'est destiné qu'à une usage domestique et n'a pas été conçu pour un usage commercial dans les folies, crèches, etc.
22. La défaillance de l'assemblage de cet équipement conformément à l'instruction peut causer un préjudice à l'utilisateur.
23. Veuillez garder les instructions dans une place sécuritaire pour une référence future.
24. Age applicable: 3-10 ans.
25. Ne pas mettre votre main près de pièces mobiles.



Instructions d'assemblage

LISTE DES PIECES

1293_100129			
Ref	Description	Qty	Illustration
A	M6 50mm bolt	6	
B	M6 55mm bolt	4	
C	M6 35mm bolt	14	
E	M6 65mm bolt	4	
F	M8 88mm bolt	2	
G	M8 60mm bolt	9	
H	M8 45mm bolt	6	
I	M8 65mm bolt	4	
J	M6 washer	58	
K	M8 washer	39	
L	M6 spring washer	28	
M	M8 spring washer	29	

Ref	Description	Qty	Illustraion
N	Wave waher	4	
O	M6 Domenut	28	
P	M8 Domenut	29	
Q	M8 nut for U-bolt	8	
R	Ground anchor	4	
S	Top bar	2	
T	Top leg	4	
U	Bottom leg	4	
V	Glider handle tube	2	
W	Side stay bar	2	
X	Lower glider leg	2	
Y	Glider seat tube	2	
Z	Glider bracket	3	
AA	Glider seat	2	
BB	Glider footrest	2	

Ref	Description	Qty	Illustraion
CC	Swing seat	2	
DD	Plastic bearing	16	
EE	U bolt	4	
FF	Sexy bolt for footrest / lawn swing seat panel	26	
GG	Clamp	2	
II	Spanner	1	
JJ	Spanner	1	
KK	Lawn swing seat panel	6	
LL	Hand rail tube	4	
MM1	Plastic cap for 50.8mm pole	2	
MM2	Plastic cap for 45mm pole	2	
MM	Floor support tube with V-Clip	2	
NN	Middle tube	4	

Ref	Description	Qty	Illustraion
NN1	Seat back tube	4	
NN2	Seat tube	4	

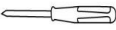
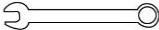
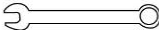
- Tools required :
1. "A-Frame" Ladder
 2. Philips head screw driver 
 3. Combination Wrench 10 
 4. Combination Wrench 13 

Étapes d'assemblage :

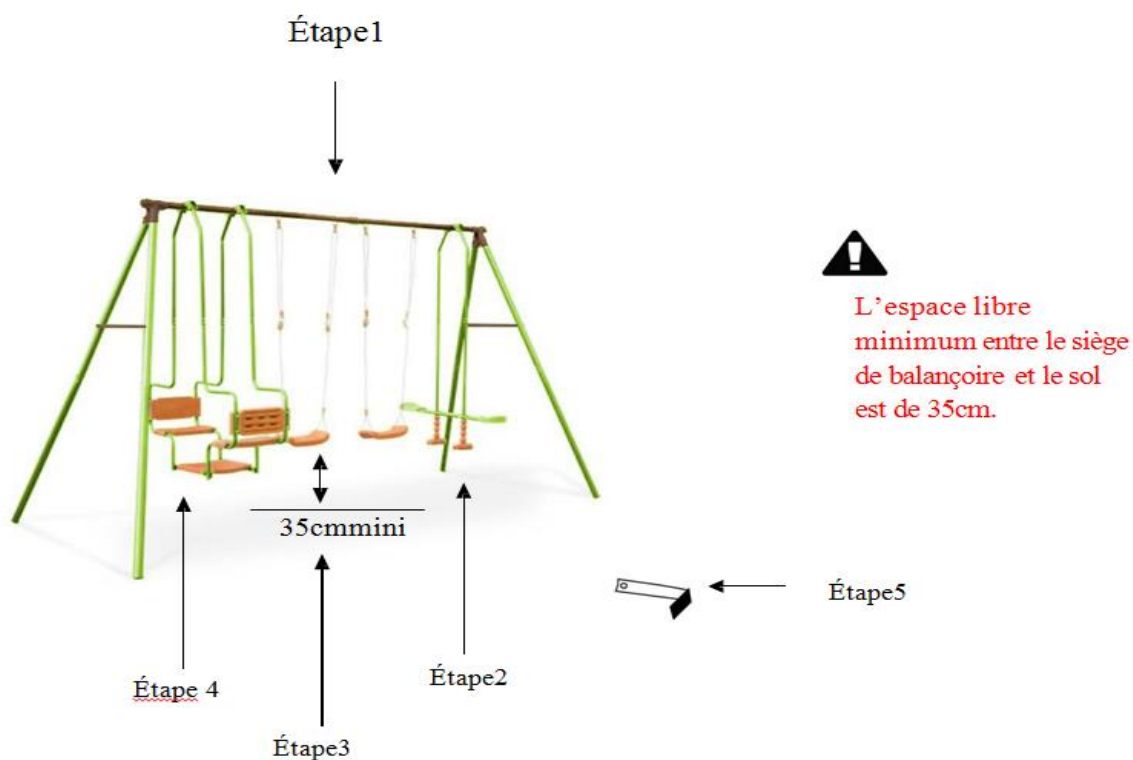

Étape1 Assemblage du cadre

- 1.-1 Connecter les 2 barres en haut (S), en utilisant un kit de boulons (boulon Gx1 + rondelle Kx1 + rondelle élastique Mx1 + écrou à dôme Px1).
- 1.-2 Connecter la barre en haut (S), le pilier en haut (T) et le serre (GG) à l'aide d'un kit de boulons (boulon lx2 + rondelle Kx2 + rondelle élastique Mx2 + écrou à dôme Px2) sur la barre en haut et (boulon Gx4 + rondelle Kx4 + rondelle élastique Mx4 + écrou à dôme Px4) sur le pilier en haut.
- 1.-3 Fixer la barre de côté W aux piliers (T & U) à l'aide d'un kit de boulons (boulon Ex2 + rondelle Jx2 + rondelle ondulée Nx2, rondelle élastique Lx2 + écrou à dôme Ox2).

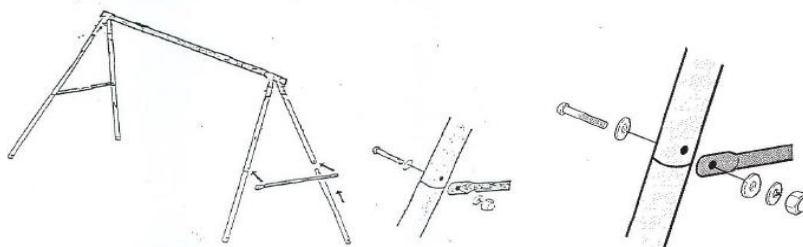

- 1.-4 Insérer le capuchon en plastique (MM1) dans les deux extrémités de la barre en haut (S) et insérer le capuchon en plastique (MM2) aux piliers (T).

Étape2 Assemblage de la balancelle

- 2.-1 Combiner le support de balancelle Z à la barre en haut S, à l'aide d'un kit de boulons (boulon Ax1 + rondelle Jx2 + rondelle élastique Lx1 + écrou à dôme O x1).

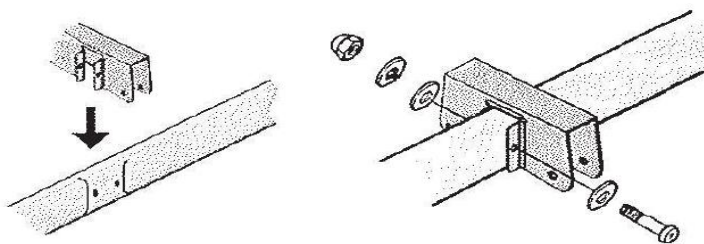

2.-2 Insérer le palier en plastique (DD) dans les deux extrémités du tube de poignée (V) et les fixer sur le support de balancelle (Z) à l'aide d'un kit de boulons (boulon Hx1 + rondelle Kx1 + rondelle élastique Mx1 + écrou à dôme Px1).

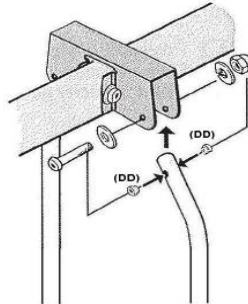

2.-3 Fixer le palier de balancelle inférieur (X) au tube de poignée de balancelle (V) à l'aide d'un kit de boulons (boulon Cx1 + rondelle Jx1 + rondelle élastique Lx1 + écrou à dôme Ox1).

2.-4 Insérer le roulement en plastique (DD) dans les deux extrémités du palier de balancelle inférieur (X) et fixer le tube de siège de balancelle (Y) à l'aide d'un kit de boulons (boulon Fx1 + rondelle Kx2 + rondelle élastique Mx1 + écrou à dôme Px1). Il faut assurer le côté concave de tube de siège de balancelle vers le bas comme indiqué ci-dessous.

2.-5 Fixer le siège de balancelle (AA) au tube de siège de balancelle (Y) à l'aide d'un kit de boulons (boulon Cx1 + rondelle Jx1 + rondelle élastique Lx1 + écrou à dôme Ox1.)

2.-6 Fixer le repose-pied de balancelle (BB) au tube de palier de balancelle inférieur (X) à l'aide d'un kit de boulons (boulon FFx1).

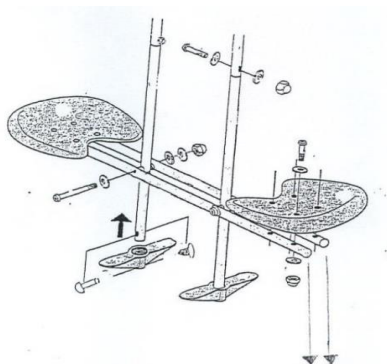

Le côté concave de tube de siège de balancelle vers le bas

Étape3 Assemblage des sièges de balançoires X 2

- 3.-1 Fixer le siège de balançoire (CC) à la barre en haut (S) à l'aide d'un kit de boulons en U (boulon en U EE_{x1} + rondelle K_{x4} + rondelle élastique M_{x2} + écrou Q_{x2} + écrou à dôme P_{x2}).

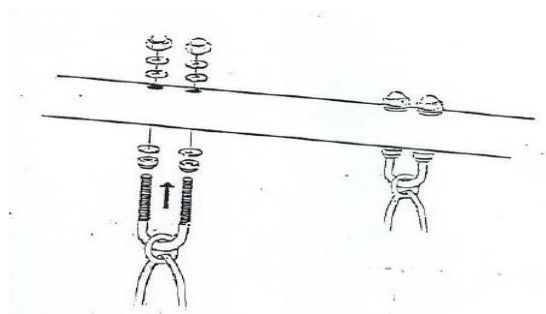

- 3.-2 Fixer un autre siège de balançoire (CC) à la barre en haut (S) à l'aide d'un kit de boulons en U (boulon en U EE_{x1} + rondelle K_{x4} + rondelle élastique M_{x2} + écrou Q_{x2} + écrou à dôme P_{x2}).

Étape4 Assemblage de la balançoire de pelouse

- 4.-1 Combiner le support de balancelle Z à la barre en haut S, à l'aide d'un kit de boulons (boulon A_{x1} + rondelle J_{x2} + rondelle élastique L_{x1} + écrou à dôme O_{x1}). Insérer le roulement en plastique (DD) dans les deux côtés du tube de main courante (LL) et les fixer au support de balancelle (Z) à l'aide d'un kit de boulons (boulon H_{x1} + rondelle K_{x1} + rondelle élastique M_{x1} + écrou à dôme P_{x1}).
- 4.-2 Insérer le tube de support au sol avec clip en V (MM) dans le tube de siège (NN2)
- 4.-3 Fixer le panneau du siège de balançoire (KK) au tube intermédiaire (NN), au tube du dos du siège (NN1) et au tube de siège (NN2) à l'aide d'un kit de boulons (boulon mâle et femelle FF + rondelle J_{x4}).
- 4.-4 Placer le tube de support au sol (MM) sous le panneau de siège de balançoire (KK), et les fixer à l'aide d'un kit de boulons (boulon mâle et femelle FF + rondelle J_{x4}).
- 4.-5 Fixer le tube intermédiaire (NN) au tube de main courante (LL) à l'aide d'un kit de boulons (boulon C_{x1} + rondelle J_{x1} + rondelle élastique L_{x1} + écrou à dôme O_{x1}).

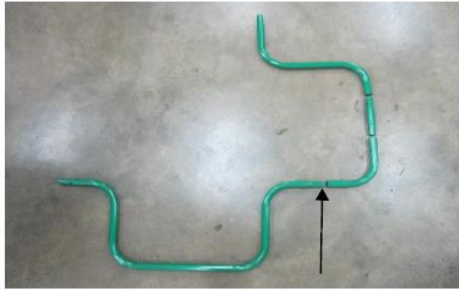

4.-2

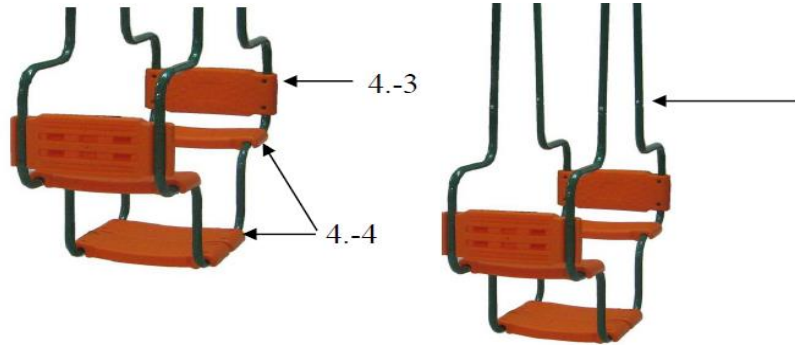

Étape5 Assemblage de l'ancre de terre

- 5.-1 Fixer l'ancre de terre R dans le trou en bas de chaque pilier en utilisant un kit de boulons (boulon Bx1 + rondelle Jx1 + rondelle élastique Lx1 + écrou à dôme Ox1).
- 5.-2 Creuser une grotte d'une profondeur de 40 cm et y mettre du ciment au format de 35x35x30cm (LxWxH). Prendre l'ancre de terre R dans le ciment lorsque celui-ci est mou.
- 5.-3 Il faut assurer que l'ancre de terre R est bien fixé dans le ciment pour empêcher ce produit de se renverser. Lorsque le ciment est pris, il faut recouvrir la grotte de sol.
- 5.-4 Lorsque vous choisissez un emplacement pour installer l'équipement, il faut tenir compte de l'espace requis pour l'activité de formation qui permet une marge au moins de 2 m de tous les côtés. Pour cette raison, il faut éviter de positionner l'équipement à proximité d'éléments en saillie, de murs, d'arbres, etc.
- 5.-5 Une fois que l'équipement est assemblé, il faut assurer qu'il est placé correctement et en toute sécurité, et jamais sur un tapis (il doit être parfaitement stable, surtout aux conditions de charge maximum).
- 5.-6 Ne pas installer l'équipement dans le sauna ou aucun endroit humide.

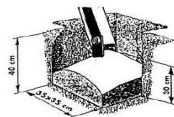

Entretien et Maintenance









1. Cet équipement doit être assemblé et examiné par un adulte.
2. Vérifiez régulièrement tous les écrous et vis pour une bonne fixation avant l'utilisation et remplacez les parties usées, défectueuses ou manquantes. NE PAS essayer de réparer les parties détériorées.
3. Vérifiez régulièrement si les sièges, cordes, balancelles, tubes d'acier, ancrages du sol et d'autres parties sont complètement serrés et remplacez les parties usées & détériorées si nécessaire. Si ces contrôles ne sont pas effectués, cet équipement pourra renverser ou devenir un danger.
4. Déplacez les parties usées et détériorées jusqu'à ce que les parties de remplacement soient montées.
5. Remplacez les parties défectueuses conformément aux instructions du fabricant.
6. Au début de chaque saison, veuillez lubrifier toutes les parties métalliques mobiles si nécessaire et lubrifier régulièrement pendant l'utilisation de saison.
7. Pose de la série de balançoire et balancelle:
 - (a) Posez cet équipement sur un plan horizontal au minimum 2 mètres à aucune structure ou obstruction. Par exemple, une clôture, garage, maison, branches en surplomb, ligne de linge ou câbles électriques.
 - (b) NE PAS installer cet équipement sur la surface dure telle qu'en béton, asphalte, etc.
 - (c) Posez cet équipement dans un endroit bien éclairé.
 - (d) Ne pas l'utiliser à l'intérieur.
8. Condition du climat:
 - (a) Le siège de la balancelle, la repose - pieds et le siège de la balançoire devraient être gardés secs - ne pas utiliser lorsque ces parties sont mouillées.
 - (b) Le mouvement du vent et de l'air devrait être calme et doux.
 - (c) Veuillez ne pas utiliser le produit en face du soleil direct pour éviter l'influence de la visibilité ou de changer l'orientation pour laisser le soleil derrière.
9. Cet équipement n'est pas conçu pour les adultes ou le poids combiné de 5 enfants dont le poids maximal ne dépasse pas à un 175kgs. (35 kgs pour chaque élément)
10. Veuillez garder les instructions dans une place sécuritaire pour une référence future.
11. Gardez propre de cet équipement.

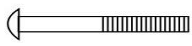
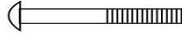

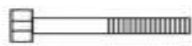











Sicherheitshinweise











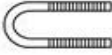
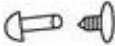

Um Schäden und Unfälle an Personen und/der Sachwerten zu vermeiden, müssen die folgenden Anweisungen und Hinweise befolgt werden:



1. Lesen Sie alle Teile dieses Handbuchs sorgfältig durch und befolgen Sie die Anweisungen vor der Verwendung.
2. Verwenden Sie kein anderes Zubehör als das mitgelieferte und/oder angegebene vom Hersteller.
3. Nicht für Kinder unter 3 Jahren geeignet.
4. Dieses Gerät muss von einem Erwachsenen zusammengebaut und geprüft werden.
5. Bitte bewahren Sie die vollständige Anleitung für spätere Nutzung auf.
6. "Warnung. Nur für den Hausgebrauch und Außenbereich."
7. Überprüfen Sie alle Muttern und Schrauben auf Festigkeit, ziehen Sie sie gegebenenfalls fest.
8. Überprüfen Sie alle Abdeckungen und Schrauben auf scharfe Kanten und ersetzen Sie sie bei Bedarf.
9. Stellen Sie dieses Gerät mindestens 2 Meter von Gebäuden oder Hindernissen entfernt auf eine ebenen Fläche. Als Hinderniss gehört auch ein Zaun, eine Garage, ein Haus, überhängende Äste, Wäscheleine oder elektrische Leitungen dazu.
10. Andere Personen dürfen sich während des Betriebs niemals innerhalb des Nutzungsbereichs des Geräts aufhalten.
11. Installieren Sie dieses Gerät nicht auf Beton, Asphalt oder anderen harten Oberflächen.
12. Lassen Sie alle Anschlüsse locker, bis die Montage abgeschlossen ist (zur Vereinfachung der Konstruktion). Ziehen Sie sie dann fest.
13. Beaufsichtigen Sie immer kleine Kinder beim spielen, bis sie körperlich bereit und selbstsicher sind.
14. Dieses Gerät ist nicht für Erwachsene oder ein Gesamtgewicht von 5 Kindern vorgesehen, Höchstgewicht beträgt 175 kg. (35 kg einzelnes Gewicht)
15. Lassen Sie Kinder nicht auf der Schaukel stehen und lassen Sie nicht zu viele Kinder auf die Schaukel gleichzeitig.
16. Lassen Sie Kinder nicht von der Schaukel absteigen, wenn Sie noch in Bewegung ist.
17. Lassen Sie keine Baggy(oder Hoodie) Kleidung zu weil die Kinder sich möglicherweise nicht mehr selbst befreien können.
18. Lassen Sie Kinder nicht auf der Schaukel klettern.
19. Überprüfen Sie die Schaukel regelmäßig auf Abnutzung und Beschädigungen, entfernen Sie die Schaukel gegebenenfalls, bis Ersatzteile eingesetzt werden.
20. Entfernen Sie bitte alle Verpackungen einschließlich Schrumpffolie, Polybeutel, Karton, Palette usw. bevor Sie ein Kind ranlassen.
21. Dieses Produkt ist nur für den Hausgebrauch bestimmt und ist nicht für den kommerziellen Gebrauch in Fitnesscentern, Kindergärten usw. konzipiert.
22. Wenn dieses Gerät nicht gemäß den Anweisungen montiert wird, kann dies zu Verletzungen des Benutzers führen.
23. Bitte bewahren Sie dieses Handbuch an einem sicheren Ort auf.
24. Passendes Alter: 3-10 Jahre.
25. Halten Sie Ihre Hand nicht in der Nähe der beweglichen Teilen.

Bauanleitung **Bauteile-Liste**

Ref	Description	Qty	Illustration
A	M6 50mm bolt	6	
B	M6 55mm bolt	4	
C	M6 35mm bolt	14	
E	M6 65mm bolt	4	
F	M8 88mm bolt	2	
G	M8 60mm bolt	9	
H	M8 45mm bolt	6	
I	M8 65mm bolt	4	
J	M6 washer	58	
K	M8 washer	39	
L	M6 spring washer	28	
M	M8 spring washer	29	

Ref	Description	Qty	Illustraion
N	Wave waher	4	
O	M6 Domenut	28	
P	M8 Domenut	29	
Q	M8 nut for U-bolt	8	
R	Ground anchor	4	
S	Top bar	2	
T	Top leg	4	
U	Bottom leg	4	
V	Glider handle tube	2	
W	Side stay bar	2	
X	Lower glider leg	2	
Y	Glider seat tube	2	
Z	Glider bracket	3	
AA	Glider seat	2	
BB	Glider footrest	2	

Ref	Description	Qty	Illustraion
CC	Swing seat	2	
DD	Plastic bearing	16	
EE	U bolt	4	
FF	Sexy bolt for footrest / lawn swing seat panel	26	
GG	Clamp	2	
II	Spanner	1	
JJ	Spanner	1	
KK	Lawn swing seat panel	6	
LL	Hand rail tube	4	
MM1	Plastic cap for 50.8mm pole	2	
MM2	Plastic cap for 45mm pole	2	
MM	Floor support tube with V-Clip	2	
NN	Middle tube	4	

Ref	Description	Qty	Illustraion
NN1	Seat back tube	4	
NN2	Seat tube	4	

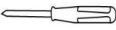
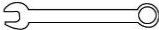
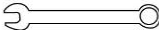
- Tools required :
1. "A-Frame" Ladder
 2. Philips head screw driver 
 3. Combination Wrench 10 
 4. Combination Wrench 13 

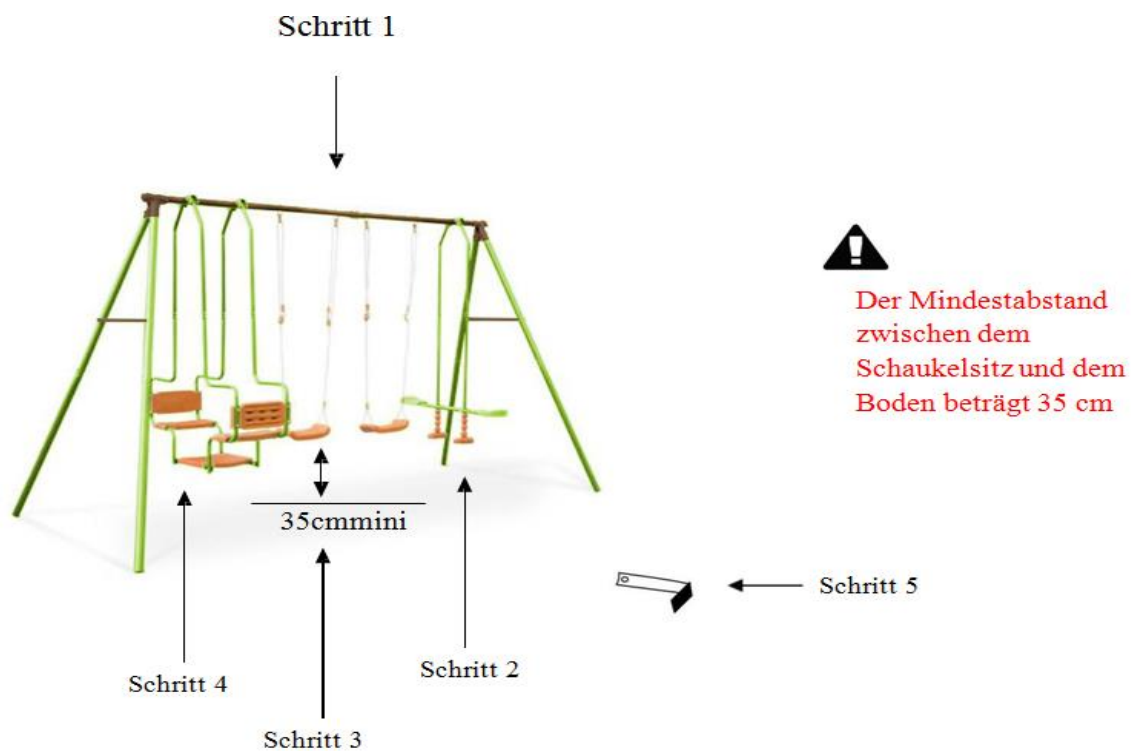

Schritt 1 Den Rahmen montieren

- 1.-1 Verbinden Sie die 2-teilige obere Balken S mit dem Schraubensatz (Schraube Gx1 + Scheibe Kx1 + Federscheibe Mx1 + Fuß Px1).
- 1.-2 Verbinden Sie den oberen Balken S, das obere Bein T und die Klemme (GG) mit dem Schraubensatz (Schraube lx2 + Scheibe Kx2 + Federscheibe Mx2 + Domenut Px2) am oberen Balken und (Schraube Gx4 + Scheibe Kx4 + Federscheibe Mx4 + Domenut Px4) am oberen Bein....
- 1.-3 Befestigen Sie die Seitenbalken W am Bein (T & U) mit einem Schraubensatz (Schraube Ex2 + Scheibe Jx2 + Wellenscheibe Nx2, Federscheibe Lx2 + Domenut Ox2).

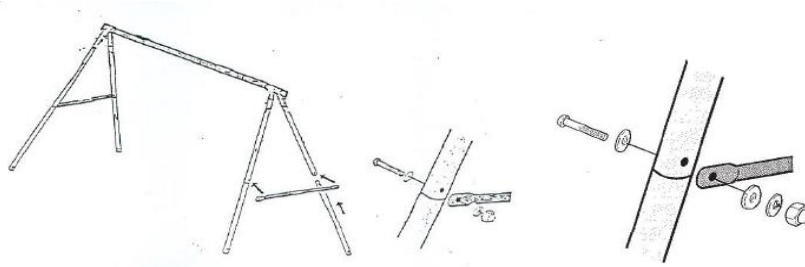

- 1.-4 Kunststoffkappe (MM1) in beide Seiten der oberen Balken (S) und Kunststoffkappe (MM2) in Bein (T) einführen

Schritt 2 Schaukel zusammenbauen

- 2.-1 Verbinden Sie die Schaukelhalterung Z mit den oberen Balken S. mit dem Schraubensatz (Schraube Ax1 + Scheibe Jx2 + Federscheibe Lx1 + Domenut Ox1).

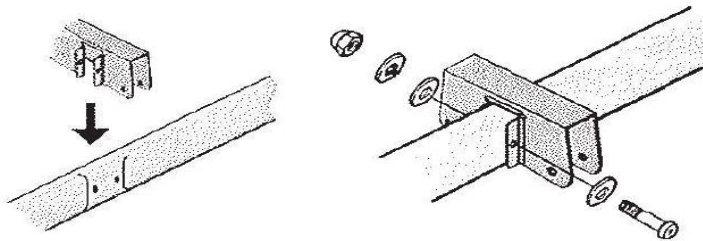

- 2.-2 Setzen Sie die Kunststoff Halterung(DD) in beide Seiten des Griffrohrs (V) ein und befestigen Sie es mit dem Schraubensatz (Schraube Hx1 + Unterlegscheibe Kx1 + Federscheibe Mx1 + Domenut Px1) an der Schaukelhalterung (Z).

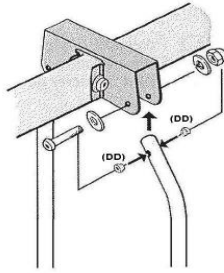

2.-3 Befestigen Sie das untere Schaukelbeinrohr X mit dem Schraubensatz (Schaukel Cx1 + Scheibe Jx1 + Federscheibe Lx1 + Domenut Ox1) am Gleitergriffrohr V.

2.-4 Setzen Sie ein Kunststoff Halterung (DD) in beide Seiten des unteren Gleitrohrrohrs (X) ein und befestigen Sie das Schaukelsitzrohr (Y) mit dem Schraubensatz (Schraube Fx1 + Scheibe Kx2 + Federscheibe Mx1 + Domenut Px1).

Um sicherzustellen, dass die Konkavitätsseite des Schaukelrohr wie unten gezeigt nach unten zeigt.

2.-5 Befestigen Sie den Schaukelsitz (AA) mit dem Schraubensatz (Schaukel Cx1 + Scheibe Jx1 + Federscheibe Lx1 + Domenut Ox1) am Schaukel-Sitzrohr (Y).

2.-6 Befestigen Sie die Schaukel Fußstütze (BB) mit dem Schraubensatz (Schraube FFx1) am unteren Schaukelbeinrohr (X).

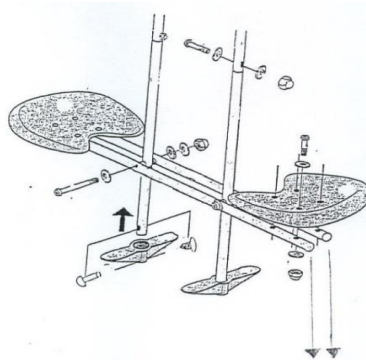

Die Konkavitätsseite des Schaukelrohr (Y) zeigt nach unten.

Schritt 3 Montage des Schaukelsitzes X 2

3.-1 Befestigen Sie den Schaukelsitz (CC) am oberen Balken (S) mit einem U-Schraubensatz (U-Schraube EEx1 + Scheibe Kx4 + Federscheibe Mx2 + Mutter Qx2 + Domenut Px2).

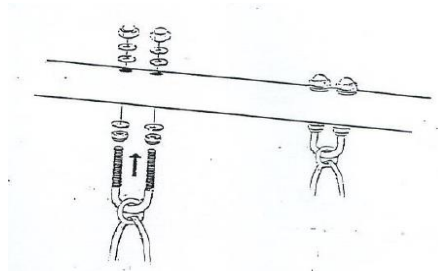

3.-2 Befestigen Sie den anderen Schaukelstuhl (CC) am oberen Balken (S) mit dem U-Schraubensatz (U-Schraube EEx1 + Scheibe Kx4 + Federscheibe Mx2 + Mutter Qx2 + Domenut Px2).

Schritt 4 Montage der Schaukel

4.-1 Verbinden Sie die Schaukelhalterung Z mit dem oberen Blaken S. mit dem Schraubensatz (Schraube Ax1 + Scheibe Jx2 + Federscheibe Lx1 + Domenut Ox1). Setzen Sie die Kunststoff Halterung (DD) in beide Seiten des Handlaufrohrs (LL) ein und befestigen Sie es mit dem Schraubensatz (Schraube Hx1 + Scheibe Kx1 + Federscheibe Mx1 + Domenut Px1) an die Halterung (Z).

4.-2 Bodenstützrohr mit V-Clip (MM) in Sitzrohr (NN2) einsetzen

4.-3 Befestigen Sie die Sitzfläche des Rasensitzes (KK) an das mittleren Rohr (NN), dem Rückenlehnenrohr (NN1) und dem Sitzrohr (NN2) mit einem Schraubensatz (Schraube FF + Scheibe Jx4).

4.-4 Setzen Sie das Bodenstützrohr (MM) unter die Sitzbank (KK) des Rasensitzes und befestigen Sie sie mit einem Schraubensatz (Schraube FF + Scheibe Jx4). Befestigen Sie das Bodenstützrohr (MM) mit der Schraube FF + Scheibe Jx4 am mittleren Rohr (NN)

4.-5 Befestigen Sie das mittlere Rohr (NN) mit dem Schraubensatz (Handschraube Cx1 + Scheibe Jx1 + Federscheibe Lx1 + Domenut Ox1) am Handlaufrohr (LL).

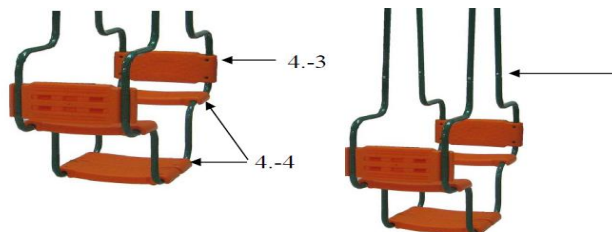
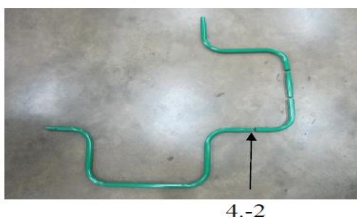

Schritt 5 Montage des Bodenanker

5.-1 Befestigen Sie den Bodenanker R in der unteren Bohrung jeder vier Beine mit einem Schraubensatz (Schraube Bx1 + Scheibe Jx1 + Federscheibe Lx1 + Domenut O_x1).

5.-2 Graben Sie eine 40cm tiefes Loch und setzen Sie Zement in der Größe 35x35x30cm (LxBxH) ein. Stellen Sie den Bodenanker R in den Zement, wenn der Zement weich ist.

5.-3 Stellen Sie sicher, dass der Erdanker R gut in Zement befestigt ist, um ein Umkippen des Produkts zu verhindern. Wenn Zement hart ist, bedecken Sie das Loch mit Erde.

5.-4 Berücksichtigen Sie bei der Auswahl eines Aufstellungsortes für die Schaukel erforderlichen Platz. Auf allen Seiten einen Abstand von mindestens 2 Meter. Vermeiden Sie es daher, die Schaukel in der Nähe von hervorstehenden Elementen, Wänden, Bäumen usw. zu positionieren..

5.-5 Wenn die Schaukel zusammengebaut ist, stellen Sie sicher, dass es sicher und absolut stabil aufgestellt ist, niemals auf dem Teppich (muss perfekt stabil sein, nicht zuletzt bei maximaler Belastung).

5.-6 Installieren Sie die Schaukel nicht in der Sauna oder in einem feuchten Bereich. Die Schaukel kann rosten.

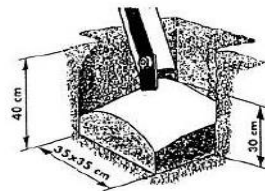

Pflege und Wartung

1. Dieses Gerät muss von einem Erwachsenen zusammengebaut und geprüft werden.
2. Überprüfen Sie vor dem benutzen regelmäßig alle Muttern und Schrauben auf festen Sitz und ersetzen Sie verschlissene, defekte oder fehlende Teile.
Versuchen Sie nicht, defekte Teile zu reparieren.
3. Regelmäßig prüfen, dass Schaukelsitz, Seile, Schirm, Stahlrohr, Bodenanker und andere Teile vollständig festgezogen sind, bei Bedarf abgenutzte und beschädigte Teile ersetzen.
Wenn diese Überprüfungen nicht durchgeführt wird, kann das Gerät umstürzen oder auf andere Weise eine Gefahr darstellen.
4. Entfernen Sie abgenutzte und beschädigte Teile, wenn dies erforderlich ist, bis Ersatzteile montiert sind.
5. Ersetzen Sie defekte Teile gemäß den Anweisungen des Herstellers.
6. Zu Beginn jeder Jahreszeit sollten Sie alle metallischen Teile einölen und regelmäßig warten.
7. Schaukel und Schaukelsitz Platzierung:
 - (a) Stellen Sie dieses Gerät mindestens 2 Meter von Gebäuden oder Hindernissen entfernt auf eine ebenen Fläche. Als Hinderniss gehört auch ein Zaun, eine Garage, ein Haus, überhängende Äste, Wäscheleine oder elektrische Leitungen dazu.
 - (b) Installieren Sie dieses Gerät nicht auf Beton, Asphalt oder anderen harten Oberflächen.
 - (c) Stellen Sie dieses Gerät an einem gut beleuchteten Ort auf.
 - (d) Verwenden Sie das Gerät nicht in Innenräumen.
8. Wetterlage:
 - (a) Sitz, Fußstütze und Schaukelsitz sollten trocken gehalten werden
- nicht bei Nässe verwenden.
 - (b) Wind oder Luftbewegung sollte ruhig und sanft sein.
 - (c) Verwenden Sie dieses Gerät nicht bei direkter Sonneneinstrahlung, dass die Sicht beeinträchtigen oder die Ausrichtung zu ändern kann.
9. Dieses Gerät ist nicht für Erwachsene oder ein Gesamtgewicht von 5 Kindern vorgesehen, Höchstgewicht beträgt 175 kg. (35 kg einzelnes Gewicht)
10. Bitte bewahren Sie dieses Handbuch an einem sicheren Ort auf.
11. Bitte halte Sie dieses Gerät sauber.

NOTAS DE SEGURIDAD









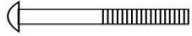

Para evitar daños y accidentes a personas y/o bienes, se deben seguir las siguientes instrucciones y consejos:



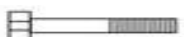











1. Lea detenidamente todas las partes de este manual y siga estrictamente las instrucciones antes de usarla.
2. No utilice accesorios que no sean los suministrados y/o especificados por el fabricante.
3. No apto para niños menores de 3 años.
4. Este equipo debe ser montado y revisado por un adulto.
5. Conserve las instrucciones completas para futuras consultas.
- 6." Advertencia. Sólo para uso doméstico y exterior."
7. Compruebe que todas las tuercas y pernos estén apretados y apriéte los cuando sea necesario.
8. Revise todos los revestimientos y pernos para obtener bordes afilados y reemplácelos cuando sea necesario.
9. Coloque este equipo en una superficie nivelada al menos a 2 metros de cualquier estructura u obstrucción. Como una valla, garaje, casa, ramas colgantes, línea de lavandería o cables eléctricos.
10. Otras personas nunca deben permitirse estar dentro del rango de acción del equipo cuando están en uso.
11. No instale este equipo sobre hormigón, asfalto o cualquier otra superficie dura.
12. Deje todos los accesorios apretados con el dedo hasta que el ensamblaje esté completo (para facilitar la construcción) y luego apriete firmemente.
13. Supervise siempre a los niños pequeños en el juego, hasta que sean físicamente competentes y seguros.
14. Este artículo no está diseñado para adultos o peso combinado de 5 niños que no excedan un peso máximo de 175Kgs. (35 kgs para cada elemento)
15. No permita que los niños se levanten sobre el planeador o asientos y sobre la carga en un elemento de juego.
16. No permita que los niños se bajen del planeador o de los asientos hasta que haya dejado de moverse.
17. No permita que la ropa suelta, holgada (o encapuchada) sea un gusano, ya que los niños pueden quedar atrapados y no pueden liberarse.
18. No permita que los niños suban en partes de este equipo que no están destinados a este propósito.
19. Revise periódicamente el artículo para ver si hay desgaste y daños, quitando el artículo del uso cuando sea necesario hasta que se hayan colocado piezas de repuesto.
20. Quite por favor todo el empaquetado incluyendo la película encogido-en, el polybag, el cartón, la plataforma,... ect. antes de dar a un niño.
21. Este producto es para uso doméstico solamente y no se ha diseñado para el uso comercial en centros de aptitud del juego, viveros, etc.
22. El no ensamblar este artículo según la instrucción puede causar lesión al usuario.
23. Por favor, conserve estas instrucciones en un lugar seguro para futuras consultas.
24. Idoneidad de la edad: 3-10 años.
25. No coloque la mano cerca de las partes móviles.











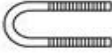
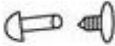

Instrucciones de montage



LISTA DE PIEZAS

1293_100129

Ref	Description	Qty	Illustration
A	M6 50mm bolt	6	
B	M6 55mm bolt	4	
C	M6 35mm bolt	14	
E	M6 65mm bolt	4	
F	M8 88mm bolt	2	
G	M8 60mm bolt	9	
H	M8 45mm bolt	6	
I	M8 65mm bolt	4	
J	M6 washer	58	
K	M8 washer	39	
L	M6 spring washer	28	
M	M8 spring washer	29	

Ref	Description	Qty	Illustraion
N	Wave waher	4	
O	M6 Domenut	28	
P	M8 Domenut	29	
Q	M8 nut for U-bolt	8	
R	Ground anchor	4	
S	Top bar	2	
T	Top leg	4	
U	Bottom leg	4	
V	Glider handle tube	2	
W	Side stay bar	2	
X	Lower glider leg	2	
Y	Glider seat tube	2	
Z	Glider bracket	3	
AA	Glider seat	2	
BB	Glider footrest	2	

Ref	Description	Qty	Illustraion
CC	Swing seat	2	
DD	Plastic bearing	16	
EE	U bolt	4	
FF	Sexy bolt for footrest / lawn swing seat panel	26	
GG	Clamp	2	
II	Spanner	1	
JJ	Spanner	1	
KK	Lawn swing seat panel	6	
LL	Hand rail tube	4	
MM1	Plastic cap for 50.8mm pole	2	
MM2	Plastic cap for 45mm pole	2	
MM	Floor support tube with V-Clip	2	
NN	Middle tube	4	

Ref	Description	Qty	Illustraion
NN1	Seat back tube	4	
NN2	Seat tube	4	

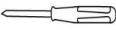
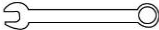
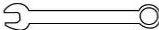
- Tools required :
1. "A-Frame" Ladder
 2. Philips head screw driver 
 3. Combination Wrench 10 
 4. Combination Wrench 13 

Pasos de ensamblaje:

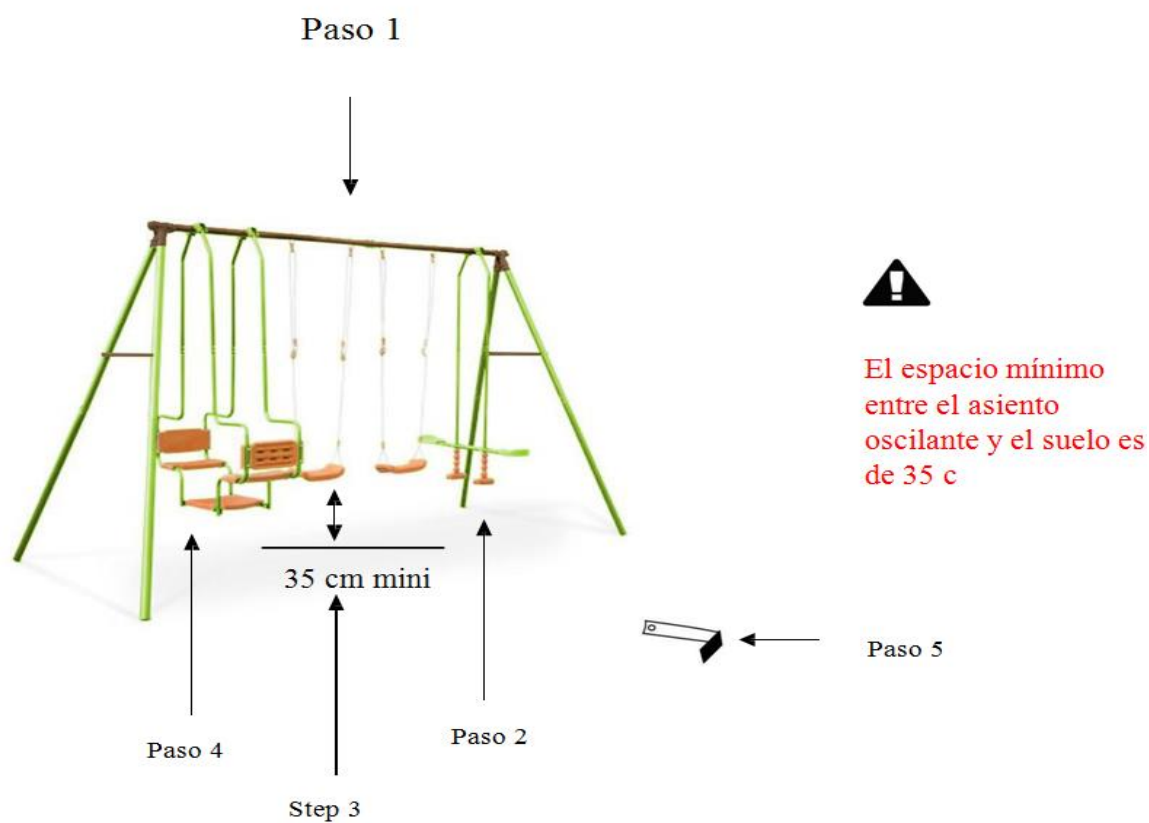

Paso 1 Montaje del marco

1.-1 Conecte la barra superior S 2pcs, usando el perno fijado (perno Gx1 + arandela Kx1 + arandela del resorte MX1 + tuerca de domo Px1).

1.-2 Conecte la barra superior S, la pata superior T y la abrazadera (GG), utilizando el juego de pernos (perno lx2 + arandela Kx2 + arandela de resorte Mx2 + tuerca de domo Px2) en la barra superior y (perno Gx4 + arandela Kx4 + arandela de resorte MX4 + tuerca de domo PX4) en la pierna superior.

1.-3 Fije la barra lateral de la estancia W a la pierna (T & U), usando el juego de perno (perno Ex2 + arandela Jx2 + arandela de onda Nx2, arandela de resorte Lx2 + tuerca de domo Ox2)

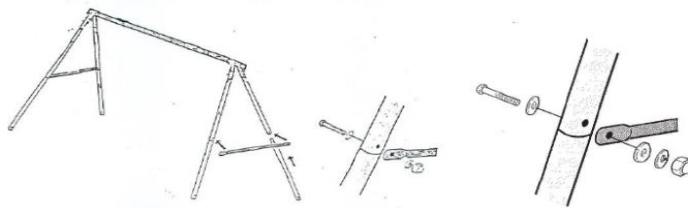

1.-4 Inserte la tapa plástica (MM1) en ambos lados de la barra superior (S) y la tapa plástica (MM2) en la pierna (T)

Paso 2 Montaje del planeador

2.-1 Combine el soporte del planeador Z con la barra superior S. usando el juego de pernos (perno Ax1 + arandela Jx2 + arandela de resorte Lx1 + tuerca de domo Ox1).

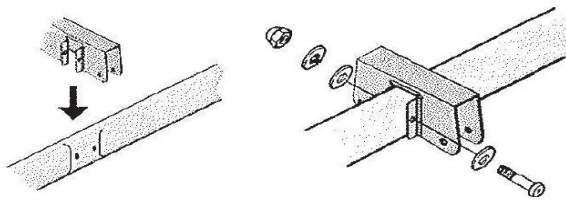

2.-2 Inserte el cojinete de plástico (DD) en ambos lados del tubo de la manija (V) y fije al soporte del planeador (Z), usando el perno fijado (perno Hx1 + arandela Kx1 + arandela del resorte Mx1 + tuerca de domo Px1)

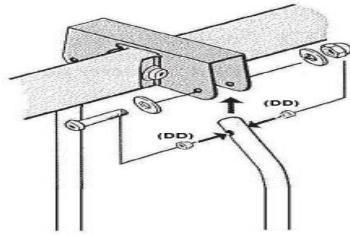

2.-3 Fije el tubo de la pata del planeador más bajo X al tubo de la manija del planeador V usando el perno fijado (perno Cx1 + arandela Jx1 + arandela del resorte Lx1 + tuerca de domo Ox1).

2.-4 Inserte el cojinete de plástico (DD) en ambos lados del tubo de la pata del planeador inferior (X) y fije el tubo del asiento del planeador (Y), usando el juego de pernos (perno Fx1 + arandela Kx2 + arandela de resorte Mx1 + tuerca de domo Px1). Para asegurar el lado de la concavidad del tubo del sistema del planeador boca abajo como abajo.

2.-5 Fije el asiento del planeador (AA) al tubo del asiento del planeador (Y) usando el perno fijado (perno Cx1 + arandela Jx1 + arandela del resorte Lx1 + tuerca de domo Ox1.)

2.-6 Fije el reposapiés del planeador (BB) al tubo inferior de la pata del planeador (X) usando el juego de pernos (perno FFx1).

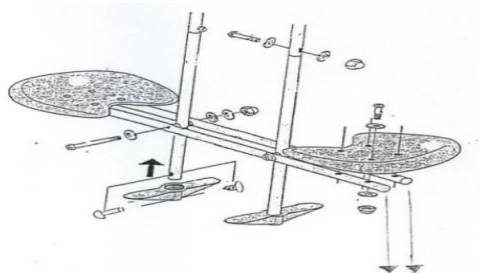

El lado de la concavidad del tubo del asiento del planeador (Y) boca abajo.

Paso 3 Montaje del asiento giratorio X 2

3.-1 Fije el asiento giratorio (CC) a la barra superior (S) usando el conjunto de pernos U (perno U EEx1 + arandela Kx4+ arandela de resorte Mx2 + tuerca Qx2 + tuerca de domo Px2).

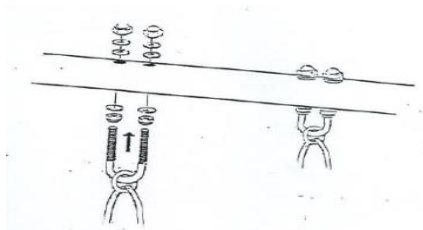

3.-2 Fije el otro asiento giratorio (CC) a la barra (S) superior usando el conjunto de pernos U (perno U EEx1+ arandela Kx4 + arandela de resorte Mx2 + tuerca Qx2 + tuerca de domo Px2).

Paso 4 Montaje del columpio de césped

4-1 Combine el soporte del planeador Z con la barra superior S.usando el juego de pernos (perno Ax1 + arandela Jx2 + arandela de resorte Lx1 + tuerca de domo Ox1).
 Inserte el cojinete de plástico (DD) en ambos lados del tubo de la barandilla (LL) y fíjese al soporte (Z), usando el conjunto de pernos (perno Hx1 + arandela Kx1 + arandela de resorte Mx1 + tuerca de domo Px1)

4-2 Inserte el tubo de soporte del piso con el V-clip (milímetro) en el tubo del asiento NN2

4.-3 Fije el panel del asiento del oscilación del césped (KK) al tubo medio (NN), tubo trasero del asiento (NN1) y el tubo del asiento (NN2) usando el perno fijado (perno atractivo FF + arandela Jx4).

4.-4 Ponga el tubo de soporte del piso (milímetro) debajo del panel del asiento del oscilación del césped (KK), fijándolos usando el sistema del perno (perno atractivo FF + arandela Jx4).
 Fije el tubo de soporte del piso (MM) al tubo medio (NN) utilizando perno atractivo FF + arandela Jx4

4.-5 Fije el tubo medio (NN) al tubo de la barandilla (LL), usando el perno fijado (perno Cx1 + arandela Jx1 + arandela del resorte Lx1 + tuerca de domo Ox1).

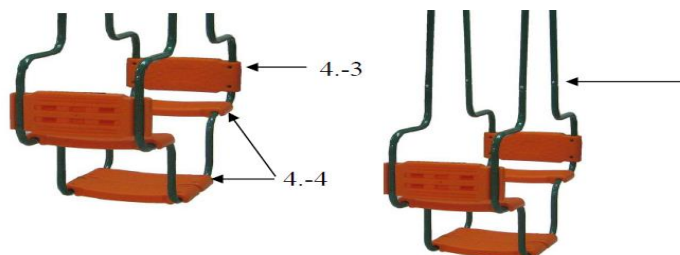
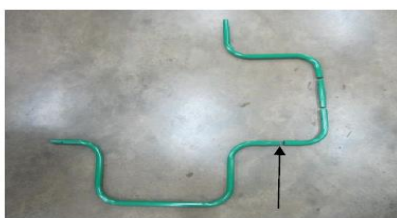

Paso 5 Montaje de los anclajes gound

5.-1 Fije el anclaje de tierra R en el orificio inferior de cada 4 patas, utilizando el conjunto de pernos (perno Bx1 + arandela Jx1 + arandela de resorte Lx1 + tuerca de domo Ox1).

5.-2 Cavar 40cm profundidad cueva y poner cemento en tamaño 35x35x30cm (LxWxH). Tome el anclaje de tierra R en el cemento cuando el cemento esté blando.

5.-3 Asegúrese de que el anclaje de tierra R esté bien fijado en el cemento para evitar que este producto se vuelque. Cuando el cemento es duro, cubra la cueva con el suelo.

5.-4 Al seleccionar un lugar para instalar el equipo, tenga en cuenta el espacio necesario para la actividad de entrenamiento. Permitiendo un margen de al menos 2 m en todos los lados. Por esta razón, evite posicionar el equipo cerca de elementos salientes, paredes, treescape, etc.

5.-5 Una vez que el equipo ha sido montado, asegúrese de que se coloca de forma segura y completamente estable, nunca en la alfombra (que debe ser perfectamente estables, no menos en condiciones de carga máxima).

5.-6 No instale el equipo dentro de la sauna ni en ninguna zona húmeda. Porque puede causar oxidado.

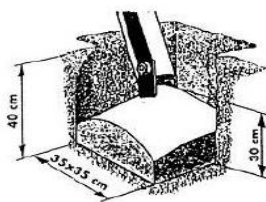

Cuidado y mantenimiento

1. Este equipo debe ser montado y revisado por un adulto.
2. Compruebe periódicamente que todas las tuercas y pernos estén apretados antes de usarlo y Reemplace cualquier pieza desgastada, defectuosa o faltante.
No intente repaire piezas rotas.
3. Compruebe regularmente el asiento del columpio, cuerdas, planeador, tubo de acero, anclaje de tierra y otras partes se aprietan completamente y reemplace las piezas desgastadas y dañadas cuando sea necesario. Si no se llevan a cabo estos controles, este equipo podría derredar o convertirse en un peligro.
4. Quite las piezas desgastadas y deterioradas del uso cuando sea necesario hasta que se hayan colocado piezas de repuesto.
5. Reemplace las piezas defectuosas de acuerdo con las instrucciones del fabricante.
6. Al principio de cada estación, por favor aceitar todas las piezas metálicas de movimiento para mantener y regularmente aceite cuando sea necesario durante la temporada de uso.
7. Colocación del oscilación y del planeador:
 - (a) Coloque este equipo en una superficie nivelada al menos a 2 metros de cualquier estructura u obstrucción. Como una valla, garaje, casa, ramas colgantes, línea de lavandería o cables eléctricos.
 - (b) No instale este equipo sobre hormigón, asfalto o cualquier otra superficie dura.
 - (c) Coloque este equipo en un área bien iluminada.
 - (d) No utilice el interior.
8. Condiciones meteorológicas:
 - (a) El asiento del planeador, el reposapiés y el asiento del columpio deben mantenerse secos--no usar cuando estas piezas están mojadas.
 - (b) El movimiento del viento o del aire debe ser tranquilo y suave.
 - (c) Por favor, no utilice cuando el sol de la cara directamente para afectar la visibilidad o cambiar la orientación para dejar atrás el sol.
9. Este artículo no está diseñado para adultos o peso combinado de 5 niños que no exceda un Maximumweight de 175Kgs. (35 kgs para cada elemento)
10. Por favor, conserve estas instrucciones en un lugar seguro para futuras consultas.
11. Para mantener limpio este equipo.

NOTE DI SICUREZZA









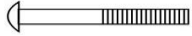

Per prevenire il danno e gli incidenti agli uomini e/o beni, le seguenti istruzioni e consigli vengono rispettati:



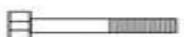











1. Leggere attentamente tutte le parti di questo manuale e seguire rigorosamente le istruzioni prima dell'uso.
2. Non usare nessun accessorio diverso da quelli forniti e/o specificati dal produttore.
3. Non idoneo per bambini sotto 3 anni.
4. L'attrezzatura viene assemblata e controllata da un adulto.
5. Per favore conservare integre le istruzioni per futuro riferimento.
6. "Avvertenza. Per uso domestico e al coperto solo."
7. Controllare tutti i dadi e bulloni per strettezza e stringere quando necessario.
8. Controllare tutte le coperture e bulloni per margini acuti e sostituirle quando necessario.
9. Posizionare l'attrezzatura alla superficie livellata distante almeno 2 metri da qualsiasi struttura o ostacolo. Come un recinto, garage, casa, rami sporgenti, il bucato o i fili elettrici.
10. Altri uomini non sono permessi mai di stare nel raggio d'azione dell'attrezzatura quando in uso.
11. NON installare l'attrezzatura sul calcestruzzo, asfalto o qualsiasi altra superficie dura.
12. Tenere strettamente tutti gli accessori affinché l'assemblaggio sia completato(per semplicità della costruzione) - poi stringerli fermamente.
13. Vigilare sempre i tuoi bambini che giocano, a meno che siano competenti e fiduciosi fisicamente.
14. L'articolo non è progettato per adulti né sostiene il peso totale di 5 bambini che supera il massimo di 175 kg. (35 kg per ogni elemento)
15. NON permettere ai bambini di stare sull'aliante o sedili e sovraccaricare un elemento da gioco.
16. NON permettere ai bambini di scendere dall'aliante o dal sedile affinché l'ultimo cessi di spostarsi.
17. NON vestire di capi sciolti, larghi(o incappucciati), perché i bambini possono essere intrappolati e sarebbero incapaci di liberarsi.
18. NON permettere ai bambini di scalare sulle parti di questa attrezzatura non progettate per questo scopo.
19. Controllare regolarmente l'articolo per usura e danno, rimuovendo l'articolo dall'uso quando necessario affinché le parti di ricambio siano montati.
20. Per favore rimuovere tutti gli imballaggi, inclusi la pellicola rimpicciolita, il sacchetto poli, il cartone, il pallet...ecc prima di darlo al bambino.
21. Questo prodotto serve meramente l'uso domestico e non è progettato per uso commerciale nelle balestre, asili nido ecc.
22. Fallisce ad assemblare l'articolo secondo l'istruzione causerebbe il danno all'utente.
23. Per favore conservare tali istruzioni al luogo sicuro per futuro riferimento.
24. Idoneità dell'età: 3-10 anni.
25. Non inserire la Sua mano alle vicinanze delle parti mobili.











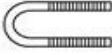
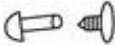

Istruzioni dell'assemblaggio



LISTA DELLE PARTI

1293_100129

Ref	Description	Qty	Illustration
A	M6 50mm bolt	6	
B	M6 55mm bolt	4	
C	M6 35mm bolt	14	
E	M6 65mm bolt	4	
F	M8 88mm bolt	2	
G	M8 60mm bolt	9	
H	M8 45mm bolt	6	
I	M8 65mm bolt	4	
J	M6 washer	58	
K	M8 washer	39	
L	M6 spring washer	28	
M	M8 spring washer	29	

Ref	Description	Qty	Illustraion
N	Wave waher	4	
O	M6 Domenut	28	
P	M8 Domenut	29	
Q	M8 nut for U-bolt	8	
R	Ground anchor	4	
S	Top bar	2	
T	Top leg	4	
U	Bottom leg	4	
V	Glider handle tube	2	
W	Side stay bar	2	
X	Lower glider leg	2	
Y	Glider seat tube	2	
Z	Glider bracket	3	
AA	Glider seat	2	
BB	Glider footrest	2	

Ref	Description	Qty	Illustraion
CC	Swing seat	2	
DD	Plastic bearing	16	
EE	U bolt	4	
FF	Sexy bolt for footrest / lawn swing seat panel	26	
GG	Clamp	2	
II	Spanner	1	
JJ	Spanner	1	
KK	Lawn swing seat panel	6	
LL	Hand rail tube	4	
MM1	Plastic cap for 50.8mm pole	2	
MM2	Plastic cap for 45mm pole	2	
MM	Floor support tube with V-Clip	2	
NN	Middle tube	4	

Ref	Description	Qty	Illustraion
NN1	Seat back tube	4	
NN2	Seat tube	4	

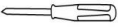
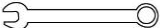
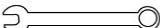
- Tools required :
1. "A-Frame" Ladder
 2. Philips head screw driver 
 3. Combination Wrench 10 
 4. Combination Wrench 13 

Passi d'Assemblaggio

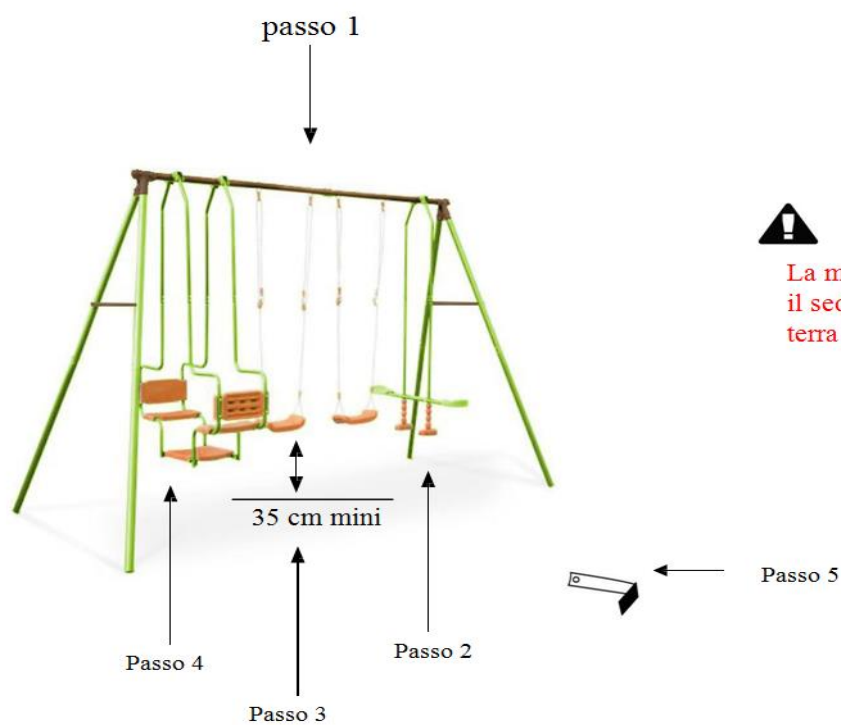

Passo 1 Assemblare il Telaio

1.-1 Connettere 2 pezzi di barra superiore S usando il set di bullone (bullone Gx1 + rondella Kx1 + rondella a molla Mx1 + Dado a cupola Px1).

1.-2 Connettere la barra superiore S, la gamba superiore T e il morsetto(GG) usando il set di bullone (bullone lx2 + rondella Kx2 + rondella a molla Mx2 + dado a cupola Px2) sulla barra superiore e (bullone Gx4 + rondella Kx4 + rondella a molla Mx4 + dado a cupola Px4) sulla gamba superiore.

1.-3 Attaccare la barra supporto laterale W alla gamba (T e U) usando il set di bullone (bullone Ex2 + rondella Jx2 + rondella a onda Nx2, rondella a molla Lx2 + dado a cupola Ox2)

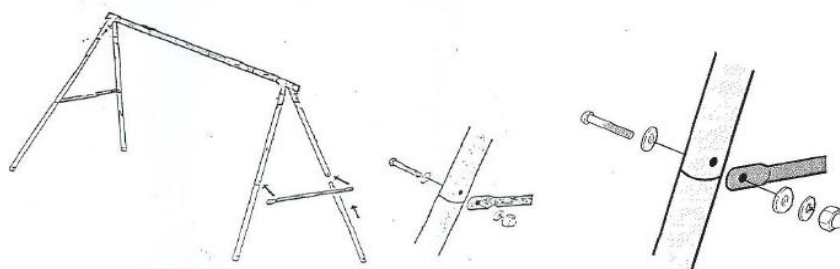

1.-4 Inserire il coperchio plastico (MM1) in entrambi i lati della barra superiore (S) ed il coperchio plastico (MM2) nella gamba (T)

Passo 2 Assemblare l'aliante

2.-1 Combinare il supporto aliante Z con la barra superiore S usando il set di bullone (bullone Ax1 + rondella Jx2 + rondella a molla Lx1 + dado a cupola Ox1).

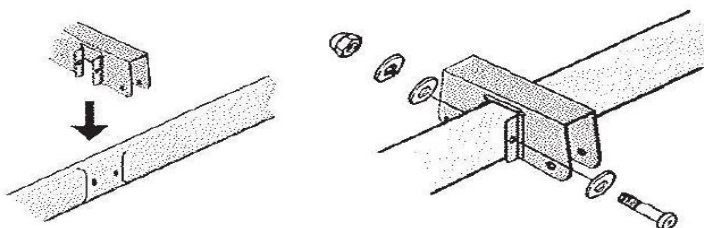

2.-2 Inserire il cuscinetto plastico (DD) in entrambi i lati del tubo maniglia (V) e attaccare al supporto aliante (Z) usando il set di bullone (bullone Hx1 + rondella Kx1 + rondella a molla Mx1 + dado a cupola Px1)

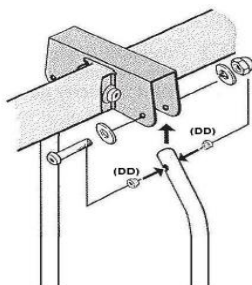

2.-3 Attaccare il tubo gamba aliante inferiore X al tubo maniglia aliante V usando il set di bullone (bullone Cx1 + rondella Jx1 + rondella a molla Lx1 + dado a cupola Ox1).

2.-4 Inserire il cuscinetto plastico (DD) in entrambi i lati del tubo gamba aliante inferiore (X) e fissare il tubo sedile aliante (Y) usando il set di bullone (bullone Fx1 + rondella Kx2 + rondella a molla Mx1 + dado a cupola Px1).
Per assicurare il lato concavo dell'aliante, volgere il tubo verso il basso come seguente.

2.-5 Fissare il sedile aliante (AA) al tubo sedile aliante (Y) usando il set di bullone (bullone Cx1 + rondella Jx1 + rondella a molla Lx1 + dado a cupola Ox1.)

2.-6 Attaccare il poggiapiedi aliante (BB) al tubo gamba aliante inferiore (X) usando il set di bullone (bullone FFx1).

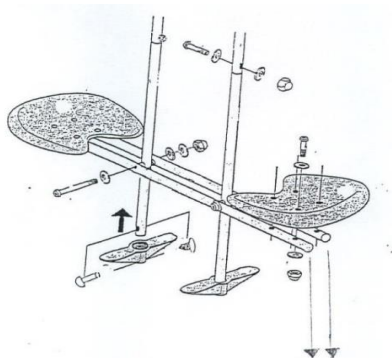

Il lato concavo del tubo sedile aliante(Y) viene volto verso il basso.

Passo 3 Assemblare il Sedile Aliante X 2

3.-1 Attaccare il sedile aliante (CC) alla barra superiore (S) usando il set di bullone U (bullone U EEx1 + rondella Kx4+ rondella a molla Mx2 + dado Qx2 + dado a cupola Px2).

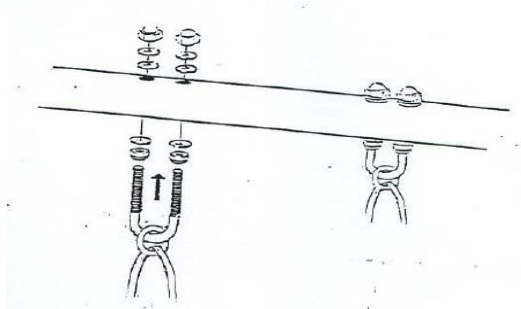

3.-2 Attaccare l'altro sedile aliante(CC) alla barra superiore (S) usando il set di bullone U (bullone U EEx1+ rondella Kx4 + rondella a molla Mx2 + dado Qx2 + dado a cupola Px2).

Passo 4 Assemblare l'Aliante da Giardino

4.-1 Combinare il supporto aliante Z con la barra superiore S usando il set di bullone (bullone Ax1 + rondella Jx2 + rondella a molla Lx1 + dado a cupola Ox1).
Inserire il cuscinetto plastico (DD) in entrambi i lati del tubo corrimano (LL) ed attaccare al supporto (Z) usando il set di bullone (bullone Hx1 + rondella Kx1 + rondella a molla Mx1 + dado a cupola Px1)

4.-2 Inserire il tubo supporto pavimento con Morsetto V(MM) nel tubo Sedile (NN2)

4.-3 Attaccare il pannello sedile aliante da giardino (KK) nel tubo medio (NN), Tubo schienale (NN1) e Tubo sedile (NN2) usando il set di bullone (bullone sessuale FF + rondella Jx4).

4.-4 Mettere il tubo supporto pavimento (MM) sotto il pannello sedile aliante da giardino (KK), fissandoli mediante il set di bullone (bullone sessuale FF + rondella Jx4).
Fissare il tubo supporto pavimento (MM) al tubo medio (NN) mediante bullone sessuale FF + rondella Jx4

4.-5 Attaccare il tubo medio (NN) al tubo corrimano (LL), usando il set di bullone (bullone Cx1 + rondella Jx1 + rondella a molla Lx1 + dado a cupola Ox1).

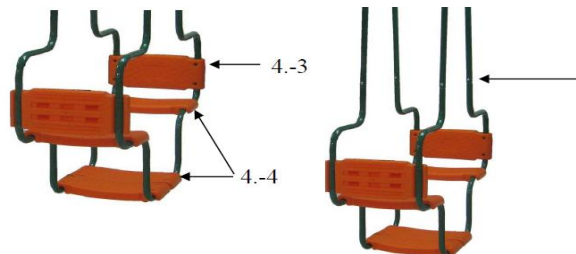
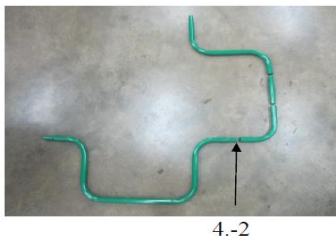

Passo 5 Assemblare le Ancore di Terra

5.-1 Fissare l'ancora di terra R nel foro di fondo di ogni 4 gambe, usando il set di bullone (bullone Bx1 + rondella Jx1 + rondella a molla Lx1 + dado a cupola Ox1).

5.-2 Scavare la grotta profonda 40cm e mettere il calcestruzzo nella dimensione di 35x35x30cm (LxPxA).
Inserire l'ancora di terra R nel calcestruzzo quando il calcestruzzo è morbido.

5.-3 Assicurare che l'ancora di terra R è fissata bene nel calcestruzzo per prevenire il ribaltamento del prodotto. Quando il calcestruzzo è rigido, coprire la grotta con il suolo.

5.-4 Nel selezionare un luogo per installare l'attrezzatura, prendere in considerazione lo spazio richiesto per l'attività di allenamento. Lasciare un margine di almeno 2 m ad entrambi i lati. Per questo motivo, evitare di posizionare l'attrezzatura vicina agli elementi sporgenti, mura, alberi ecc.

5.-5 Appena l'attrezzatura è stata assemblata, assicurare che è posizionata in sicurezza e completamente stabile, non sul tappeto mai (deve essere stabile perfettamente, almeno sotto le condizioni del massimo carico).

5.-6 Non installare l'attrezzatura dentro la sauna p qualsiasi area umida. Perché causerebbe la ruggine.

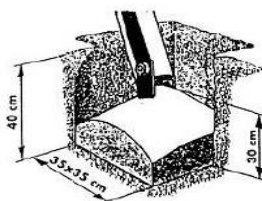

Cura e manutenzione

1. L'attrezzatura viene assemblata e controllata da un adulto.
2. Controllare regolarmente i dadi e bulloni per strettezza prima di utilizzare e sostituire qualsiasi parte usurata, difettiva o persa. **NON** cercare di riparare le parti guaste.
3. Controllare regolarmente che il sedile aliante, le corde, l'aliante, il tubo d'acciaio, l'ancora di terra e altre parti sono ristretti completamente e sostituire le parti usurate e danneggiate quando necessario. Se tali controlli non sono eseguiti, l'attrezzatura può ribaltare o diventare un pericolo.
4. Rimuovere le parti usurate e danneggiate dall'uso quando necessario affinché le parti di ricambio siano montate.
5. Sostituire le parti difettose ai sensi delle istruzioni del produttore.
6. All'inizio di ogni stagione, per favore oliare tutte le parti mobili per manutenzione e oliare regolarmente quando necessario durante la stagione d'uso.
7. Posizionamento del set di Altalena e Aliante:
 - (a) Posizionare l'attrezzatura alla superficie livellata distante almeno 2 metri da qualsiasi struttura o ostacolo. Come un recinto, garage, casa, rami sporgenti, il bucato o i fili elettrici.
 - (b) **NON** installare l'attrezzatura sul calcestruzzo, asfalto o qualsiasi altra superficie dura.
 - (c) Posizionare l'attrezzatura nell'area ben illuminata.
 - (d) Non usare all'aperto.
8. Condizione meteorologica:
 - (a) Sedile aliante, sedile poggiatesta e altalena vengono conservati secchi--non usare quando queste parti sono umide.
 - (b) Movimento del vento o dell'aria deve essere calmo e gentile.
 - (c) Per favore non usare al sole diretto che compromette la visibilità e cambiare l'orientamento per lasciare il sole all'indietro.
9. L'articolo non è progettato per adulti né sostiene il peso totale di 5 bambini che supera il massimo di 175 kg. (35 kg per ogni elemento)
10. Per favore conservare tali istruzioni al luogo sicuro per futuro riferimento.
11. Per mantenere l'attrezzatura pulita.