

# JUMPER

1210\_134631/134632/134633/134634

## 8/10/12/14FT USER MANUAL

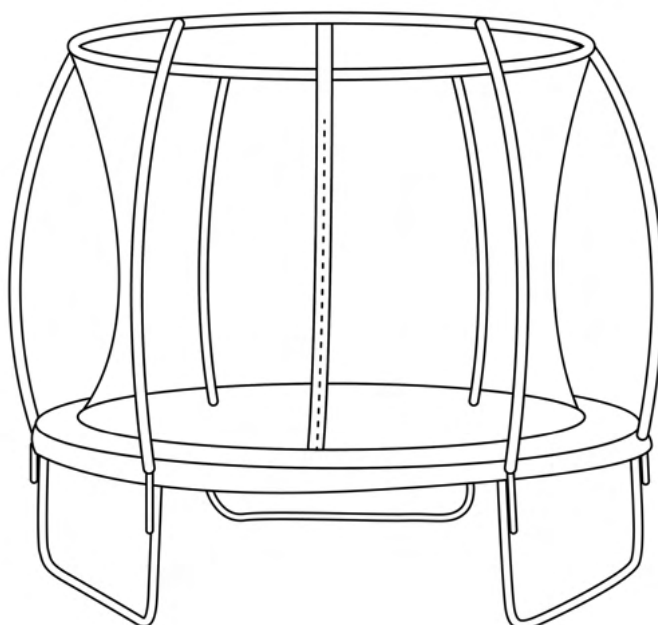

**h&j** Habitat  
et Jardin

2023-2024

## FR

L'utilisation de ce trampoline se fait à vos risques et périls ! Vous êtes responsable du maintien de sa bonne condition.

### INTRODUCTION

Avant utilisation du trampoline, veuillez lire attentivement la notice.

Comme toutes activités physiques, le trampoline comporte des risques. Afin de réduire ce risque il est indispensable que les instructions suivantes soient observées.

- Cette notice fait partie intégrante du produit. Veuillez la conserver car elle vous servira de référence en cas de besoin. Dans le cas où vous céderiez votre trampoline, n'oubliez pas de la joindre.
- Une mauvaise utilisation du trampoline peut causer des accidents graves où mortels.
- Le trampoline est un objet capable de vous faire rebondir à des hauteurs impressionnantes. De ce fait nous vous recommandons une attention particulière lors de l'utilisation de celui-ci.
- Veuillez vérifier la stabilité du tapis de saut avant chaque utilisation et assurez-vous qu'il n'y est pas de pièces manquantes.
- Vous trouverez ci-dessous des instructions concernant le montage et le démontage du trampoline, des indications de sécurité et des indications sur les techniques de sauts appropriées. N'utilisez que des techniques de saut dont vous avez la maîtrise et prenez en compte vos limites physiques.

Avant de commencer l'utilisation d'un trampoline consulter un médecin pour savoir si votre état de santé le permet.

Commencer par habituer votre corps aux sauts et aux rebondissements du trampoline. Concentrez-vous sur la position de votre corps. Pratiquez les sauts les plus simples avant de vous essayer aux plus difficiles. Ne vous laissez pas rebondir hasardeusement sur le trampoline, il s'agit plutôt d'avoir une maîtrise complète de votre corps et des différentes techniques de saut.



Il ne pas y avoir plus d'une personne à la fois sur ce trampoline !  
La présence de plus de deux personnes augmenterait le risque d'accident et de collision.



Des sauts périlleux peuvent causer des blessures sérieuses et paralysantes de la nuque ainsi que de la colonne vertébrale. **NE JAMAIS EXERCER** de sauts périlleux, salto...

2023-2024

## GUIDE DU TRAMPOLINE

### 1. INDICATIONS GENERALES

#### Emploi prévu

Ce produit est conçu pour une utilisation domestique uniquement. Il ne peut être utilisé à des fins professionnelles ou médicales.

Capacité maximale de poids sont: 80kg pour 2,44M; 150kg pour 3,05M / 3,66M / 4,27M. Le poids de l'utilisateur ne doit pas dépasser cette limite. Sinon, la garantie est automatiquement annulée.

Modèle	Hauteur du cadre	Hauteur du filet de sécurité	Diamètre total	Hauteur total (y compris la hauteur du filet de sécurité)
2,44m	60 cm	180 cm	244 cm	240 cm
3,05m	76 cm	180 cm	305 cm	256 cm
3,65m	80 cm	180 cm	366 cm	260 cm
4,25m	80 cm	180 cm	426 cm	260 cm

#### Danger pour les enfants

- Le trampoline est un jouet. Ne JAMAIS laisser des enfants à proximité sans surveillance. Veillez à ce que les consignes de sécurité soient respectées et contrôlez toute activité à proximité du trampoline.
- Veillez à ce que tout matériau d'emballage soit complètement retiré. Les sacs en plastique présentent en effet un danger d'asphyxie.
- Les trampolines dont la hauteur excède 51 cm ne sont pas adaptés pour les enfants de moins de 6 ans.
- Gardez le trampoline hors de portée des enfants et des animaux. En effet ils n'ont pas la mesure du danger potentiel que représente un trampoline.

#### Attention- En cas de dommage

- N'effectuez pas de modifications sur le produit. N'utilisez que les pièces de rechange d'origine. Les réparations ne doivent être effectuées que par des personnes qualifiées. Des réparations mal réalisées peuvent compromettre la sécurité du trampoline. N'utiliser ce produit que de la manière indiquée dans ce manuel. Protégez le trampoline de l'humidité et des températures trop élevées. Notez que l'entretien rigoureux du trampoline est essentiel à la sécurité des utilisateurs. Vérifiez toujours la viabilité des pièces dommageables.

#### Pièces dommageables :

- Tour de protection
- Barrière de sécurité
- Tapis de saut

2023-2024

- Filet de sécurité
- Notez que les propriétés anti-dérapiage du tapis de saut s'estompent avec le temps

**CONSEILS DE MONTAGE :**

- Le trampoline doit être soigneusement monté par deux personnes adultes. Pour des renseignements supplémentaires veuillez avoir recours aux services d'un technicien qualifié.
- Avant de procéder au montage lire attentivement la notice.
- Éliminez tout matériau d'emballage et étalez les pièces sur le sol. Cela vous permet d'avoir une vue d'ensemble sur toutes les pièces dont vous disposez.
- Assurez-vous que vous avez toutes les pièces nécessaires au montage
- Tout ouvrage manuel est potentiellement dangereux et peut présenter certains risques d'accident. Nous vous recommandons d'être prudent lors de ce montage.
- Ne pas laisser traîner vos outils. Tenez tous les matériaux d'emballage hors de portée des enfants (Danger d'asphyxie!). Disposez de cet emballage de manière appropriée.
- Après avoir installé le trampoline veuillez vérifier que toutes les vis et tous les écrous ont été placés correctement.
- Un espace d'au moins 8 m est nécessaire tout autour du trampoline. Il doit en effet y avoir une grande distance entre le trampoline et toute source potentielle de danger (câbles électriques ; branches d'arbres ; terrains de jeu ; piscines et clôtures...)
- Veuillez à ce que le trampoline soit correctement assemblé avant utilisation.
- Veuillez faire attention aux conditions météorologiques avant chaque utilisation du trampoline. Un tapis de saut humide et donc glissant peut causer des accidents. Utiliser votre trampoline en période de vent fort peut vous faire perdre le contrôle.
- La structure en métal peut conduire l'électricité. Aucun équipement électrique ne doit rentrer en contact avec le trampoline.
- Le trampoline doit être utilisé sur une surface plane.
- Ne placer aucun objet sous le trampoline.
- Au moment de l'assemblage et du rangement de votre trampoline nous vous recommandons l'usage de gants de protection

Informations complémentaires

**ATTENTION**

1. Assurez vous que la fermeture à glissière soit complètement fermée et que les trois clips de fixation aient été correctement fixés
2. Ne pas sauter sur le filet de protection de manière délibérée. Il est uniquement conçu pour empêcher les utilisateurs de tomber du trampoline. Sauter intentionnellement sur le filet de sécurité peut faire en sorte que le trampoline se renverse et peut l'endommager. Ce type de dommages du filet de sécurité est considéré comme de la négligence et ne donne pas lieu à l'application de la garantie

**CONSEILS DE SECURITE :**

- Attention : L'usage de ce trampoline requiert la surveillance de l'utilisateur par une personne tierce. De préférence un adulte.
- Attention : Ne convient pas aux enfants de moins de 3 ans. Ce trampoline comporte de petites pièces qui doivent être tenues hors de portée des tout petits.

2023-2024

- Attention : Il ne doit y avoir qu'une seule personne sur le trampoline à la fois. Danger de collision.
- Attention : N'effectuez pas de sauts périlleux afin d'éviter des blessures sérieuses, mortelles ou paralysante de la nuque et de la colonne vertébrale.
- Attention : Ce produit convient uniquement à un usage extérieur.
- Attention : Videz vos poches avant d'utiliser votre trampoline.
- Attention : Nous vous recommandons de mettre des vêtements de sport et de porter des baskets ou de sauter pieds nus.
- Attention : Tout vêtement avec des accros ne devrait pas être porté pendant l'usage de votre trampoline.
- Attention : N'utiliser pas le trampoline si le tapis de saut est mouillé
- Attention : Toujours sauter au milieu du tapis de saut ;
- Attention : Ne pas sortir du trampoline par un saut
- Attention : Ne pas manger en sautant
- Le trampoline n'est pas conçu pour être encastré dans le sol.
- Toujours scrupuleusement respecter les instructions de la notice
- Avant chaque utilisation scruter soigneusement votre trampoline pour vous assurer qu'il n'y ait aucune pièce endommagée. Si vous trouvez des pièces endommagées remplacez-les immédiatement et pendant ce temps n'utilisez pas votre trampoline.
- Des vents violents peuvent endommager votre trampoline. Nous recommandons ne le ranger dans un endroit protégé en cas de prévision d'une météo désavantageuse. Vous pouvez également le fixer au sol avec du cordage.
- Evitez de déplacer le trampoline lorsqu'il est complètement monté. Si cela est nécessaire de le déplacer merci de prendre en compte les recommandations suivantes : Quatre personnes au moins doivent déplacer le trampoline ; il doit à tout moment de la manœuvre être maintenu en position horizontale ; Si jamais la structure change de position réajuster la position des quatre personnes pour revenir à un maintien à l'horizontale.
- Les utilisateurs du trampoline doivent absolument prendre connaissance du contenu de manuel avant toute utilisation.
- Il est de la responsabilité du propriétaire de ce trampoline d'informer les utilisateurs des règles de sécurité et de leur application.
- Ne jamais utiliser votre trampoline à proximité d'une source d'eau et gardez un espace suffisant tout autour de lui.
- Faites attention aux pièces mobiles. Vous pourriez vous faire prendre une jambe ou un bras dedans.
- Ne coller aucun objet sur trampoline.
- Ne rien mettre absolument rien ni personne sous votre trampoline.
- Le tapis de saut est flexible et les forces allant vers le bas causées par les sauts d'un utilisateur peuvent blesser une personne qui se trouverait sous le trampoline.
- Familiarisez-vous avec les consignes de sécurité présentes dans le manuel.
- Le trampoline peut être utilisé uniquement si le tapis de saut est propre et sec ; Un tapis de saut usé et endommagé doit immédiatement être remplacé.
- Les objets dangereux doivent être retirés de l'espace réservé à votre trampoline.
- Evitez un usage non autorisé ni non supervisé du trampoline.
- Ne pas utiliser le trampoline lorsque vous êtes sous l'influence de l'alcool ou de la drogue (tout autre médicament entraînant une somnolence, ou diminution des réflexes)
- Commencer par des sauts faciles avant de pratiquer les sauts difficiles.

2023-2024

- Nous vous recommandons fortement de monter dans le trampoline en utilisant l'échelle et non de sauter directement dedans. Ne faire rebondir aucun objet sur le trampoline.
- Pour plus d'information sur les exercices et sauts à pratiquer avec votre trampoline aillez recours au service d'un professeur certifié.
- En période hivernale, L'abondance de neige et les basses températures peuvent endommager votre trampoline. Nous vous recommandons de retirer la neige de dessus votre trampoline et de conserver le tapis de saut et le filet de sécurité à l'intérieur.
- Toujours contrôler votre trampoline avant chaque utilisation.

La visserie doit être changée tous les deux ans. Le filet de sécurité également.

**Les sauts périlleux :** Ils doivent être complètement évités. Un atterrissage raté peut entraîner des accidents graves. Plus particulièrement des dommages au niveau de la colonne vertébrale, de la nuque et de la tête. Ces dommages peuvent conduire à une paralysie ou à la mort.

#### **PREVENTION DES ACCIDENTS :**

##### **Sauts périlleux et culbutes :**

Ne jamais exercer de saut périlleux et des culbutes (en avant et en arrière) afin d'éviter des blessures sérieuses, mortelles ou paralysantes de la nuque et de la colonne vertébrale.

##### **Plusieurs personnes :**

Le risque d'accident est plus élevé si plusieurs personnes utilisent simultanément le trampoline. Surtout sans contrôler leurs sauts. Les utilisateurs peuvent entrer en collision, ou tomber du trampoline. C'est généralement la personne la plus menue qui se fait le plus mal.

##### **Monter et descendre :**

Toujours monter et descendre du trampoline avec prudence. En montant sur le trampoline EVITEZ de tirer sur le filet de protection, ne marchez pas sur les ressorts et ne sautez pas sur le trampoline à partir d'autres objets en hauteur afin d'éviter les blessures. Eventuellement il est nécessaire d'aider les petits enfants à monter et à descendre du trampoline. Toujours s'appuyer à la structure en descendant du trampoline. Lorsque vous descendez du trampoline baissez vous et accrochez-vous au rebord de la structure. Et ensuite descendez en utilisant l'échelle.

##### **Structure et ressorts :**

Quand vous rebondissez sur votre trampoline visez le centre du tapis de rebond afin de ne toucher ni la structure ni les ressorts. Les ressorts et la structure doivent toujours être complètement couverts par le tapis de protection. Evitez de marcher sur le tapis de protection car il n'est pas conçu à cet effet.

##### **Perte de contrôle :**

La perte de contrôle sur un trampoline peut entraîner une mauvaise réception sur le tapis de saut, la structure ou les ressorts. Un saut contrôlé est caractérisé par le fait que la personne atterrit à l'endroit d'où elle a sauté. Apprendre les sauts fondamentaux avant de s'essayer à des sauts plus compliqués. Le risque d'accidents est accru par les signes de fatigue des utilisateurs du trampoline.

**Drogues et alcool :**

Le produit ne doit pas être utilisé par des personnes sous l'influence des drogues ou d'alcool. Ces substances peuvent en effet impacter la vision, le jugement, le temps de réaction, la coordination et les réflexes moteurs de l'individu.

Les objets étrangers au kit :

Ne pas utiliser le trampoline s'il y a un chien ou des personnes en dessous. Ne tenir aucun objet pendant les sauts et ne placer aucun objet sur le trampoline pendant vos sauts. Retirer tout câble ou branchement se trouvant au-dessus du trampoline.

**Mauvaise maintenance :**

Une mauvaise maintenance du trampoline augmente le risque d'accidents. Vérifiez que votre tapis de saut est en bon état avant chaque utilisation. Vérifiez qu'il n'y ait aucun ressort manquant ou cassé ainsi que la stabilité générale du trampoline. Si vous constatez un dommage remplacez immédiatement la pièce endommagée. Le trampoline ne doit pas être utilisé s'il est endommagé.

**Mauvaises conditions météorologiques :**

Utilisez votre trampoline uniquement dans des conditions météorologiques favorables. Un tapis de saut mouillé est forcément glissant. Par des vents violents l'utilisateur peut perdre le contrôle.

Un accès illimité au trampoline :

Conservez votre échelle dans un endroit sécurisé quand le trampoline est hors d'usage. Ceci permettra d'empêcher les enfants de l'utiliser sans la surveillance d'un adulte.

Prévention des accidents :

Le rôle de l'utilisateur :

Un minimum de connaissance du trampoline est nécessaire pour l'utiliser. Tout utilisateur doit être familiarisé avec les bases de l'exécution des sauts.

Le rôle du superviseur :

Le superviseur doit être au courant des instructions de sécurité et veiller à leur respect. Si la supervision des activités autour du trampoline n'est pas possible, alors il doit être démonté et conservé dans un endroit sécurisé. Il doit être couvert par un tarpaulin sécurisé par une chaîne scellée par un cadenas. Le superviseur doit également veiller au respect des règles de sécurité sur le trampoline.

Conseil d'utilisation :

Le trampoline doit uniquement être utilisé sous supervision quelles que soient les aptitudes des utilisateurs. La personne utilisant le trampoline doit maîtriser les techniques de saut de base. Vous devez maîtriser vos sauts. Ne rebondissez pas trop longtemps. Les sensations de fatigue accroissent le risque d'accidents. Nous recommandons au débutant de porter des vêtements à manches longues afin d'éviter les abrasions.

Montage du trampoline :

Un espace libre d'au moins 8 mètres doit être disponible tout autour du trampoline. Une distance appropriée doit être maintenue entre le trampoline et toute autre source de danger (câbles électriques, branches d'arbres, accessoires de jeu, piscine et clôtures.)

Le trampoline ne doit pas être placé sur des surfaces dures telles que le bitume, etc...

Assurez vous s'il vous plait que :

1. Le trampoline soit placé sur une surface plane et solide.
2. Qu'il soit placé dans un endroit bien éclairé
3. Aucun objet ne soit à proximité du trampoline.

**Maintenance :**

Le trampoline doit être contrôlé régulièrement et toute pièce défectueuse doit être remplacée immédiatement. Le trampoline ne doit pas être utilisé avant sa réparation complète.

Votre trampoline a été traité contre la rouille néanmoins elle peut apparaître au niveau des points de connexion ou sous les couvertures de protection. Pour les éviter lubrifiez régulièrement la structure du trampoline ainsi que les pièces de raccords avec de la vaseline ou tout autre lubrifiant. Ceci augmentera la durée de vie de la structure.

Un maintien régulier est nécessaire. Négliger cette information met en danger les utilisateurs. Les instructions de maintenance sont à appliquer au début de chaque saison d'utilisation et tout au long de celle-ci.

Contrôlez le serrage de chaque boulon et chaque écrou. Resserrez si nécessaire.

Contrôlez que les extrémités de tous les ressorts sont intactes et ne peuvent pas se détendre durant l'usage du trampoline.

Contrôlez le revêtement de chaque boulon et des rebords tranchants. Les remplacer si nécessaire.

Ne pratiquez aucune modification du trampoline. Utilisez uniquement les pièces d'origine. Les réparations se doivent d'être exécutées par une personne qualifiée. Des réparations de fortune peuvent vous mettre en danger. Respectez l'utilisation des pièces décrites dans le manuel. Un mauvais entretien de votre trampoline peut entraîner des accidents. Contrôlez la présence de dommage.

**Nettoyage :**

Essuyez le trampoline avec un chiffon doux. Ne pas utiliser de solution abrasive ou des détergents chimiques

**Emballage :**

Un emballage approprié protège votre trampoline des dommages occasionnés par le transport. L'emballage est recyclable. En disposé de manière appropriée.



Pour démonter votre trampoline, s'il vous plait faites l'inverse des instructions de votre notice.

#### **TESTEZ VOTRE TRAMPOLINE**

Après avoir monté votre trampoline, il est impératif de procéder aux vérifications suivantes :

##### **Vérification du trampoline**

- A l'aide d'un tournevis, vérifiez que les vis soient correctement serrées.
- Regardez sous le trampoline pour vous assurer que tous les ressorts de la structure soient
- correctement raccordés au tapis de saut.
  
- Remuez le trampoline pour contrôler la stabilité de la structure. Le sol doit être aplani.
- Assurez vous que les ressorts et la structure soient complètement recouverts par le tour de protection et que ce dernier soit sécurisé par les ceintures de sécurités.

##### **Vérification du filet de sécurité**

- Assurez vous que les barres supérieures et inférieures soient fixes.
- Contrôlez l'état du matériel et des coutures du filet ainsi que les clamps de fixation. Ils doivent être irréprochables.
  
- Contrôlez le fonctionnement de la fermeture éclair.
- Contrôlez l'état des œillets triangulaires.
  
- Contrôlez si les crochets sont bien placés à l'intérieure des œillets triangulaires

## TECHNIQUES DE SAUT

Le risque d'accident étant vraiment élevé pour les débutants il est essentiel qu'ils apprennent les techniques de saut de base.

Nous recommandons à tous les utilisateurs de parfaire la maîtrise de ces sauts fondamentaux.

### LE SAUT DE BASE:

- Commencez en vous tenant debout. Tenez vos pieds à une distance correspondant à la largeur de vos épaules et la tête en direction du tapis de saut.
- Faites basculer vos bras en avant et vers le haut
- Sautez les pieds joints et en pointe.
- Atterrissez avec les pieds à une distance correspondant à la largeur de vos épaules.

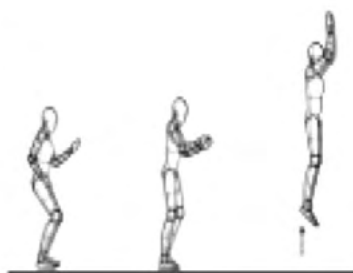

### INTERRUPTION DE SAUTS :

Il peut arriver que l'utilisateur du trampoline perde le contrôle durant un saut. Pour reprendre le contrôle et l'équilibre procédez comme suit:  
Au moment de l'atterrissage, pliez les genoux à fond. Ceci vous permettra d'interrompre votre saut.



### SAUT DE MAIN ET GENOUX:

Commencez par un saut de base bas et contrôlé  
Atterrissez sur vos mains et genoux et tenez votre dos en position droite.  
Une attention particulière doit être mise sur une excellente réception au niveau des 4 points d'appui.



**SAUT DE GENOUX:**

Commencez par un saut de base bas.  
Atterrissez sur vos genoux et tenez votre dos en position droite. Ensuite tenez vous debout et gardez l'équilibre en utilisant vos bras.

Revenez à votre position initiale en faisant basculer vos bras.

**SAUT SUR LE SIEGE :**







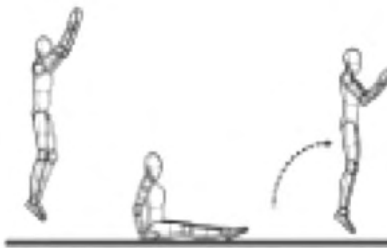









Atterrissez en position assise avec les pieds tendus vers l'avant.

Pendant votre atterrissage placez les mains à plat de part et d'autre de votre corps à la hauteur de vos hanches.

Revenez à une position verticale (debout) en vous appuyant sur vos mains.



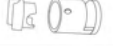















## LISTE DES PIÈCES DU TRAMPOLINE 8FT

1210_134631					
A1		Support du châssis supérieur	1220mm	x6	1/2
B1		Tour de protection		X1	1/2
C1		Tapis de saut	2010 mm	X1	1/2
D		Ressorts	145mm	X48	1/2
E		Rallonge des	/	/	
F1		Pieds	1200mm	X3	1/2
G		Clip	45mm	/	
H		Outil pour le montage		X1	1/2
I		Connecteur en t		X6	1/2
J1		Filet de sécurité	1800mm	X1	1/2
K		Pôle supérieur	1070mm	X6	2/2
L		Pôle inférieur	1070mm	X6	2/2
M		Clip	75mm	X12	1/2
N		Outil de montage		X1	1/2
O		Casquette		X6	1/2
P1		Corde	7,7 m	X1	1/2
Q1		Tige en fibre	104 cm	X6	1/2

















2023-2024

## LISTE DES PIÈCES DU TRAMPOLINE 10 FT

1210_134632					
A2		Support du châssis supérieur	1500 mm	x6	1/2
B2		Tour de protection		X1	2/2
C2		Tapis de saut	2610mm	X1	1/2
D		Ressorts	145mm	X60	2/2
E		Rallonge des	510 mm	X6	2/2
F2		Pieds	150 0 mm	X3	1/2
G		Clip	45mm	X6	1/2
H		Outil pour le montage		X1	1/2
I		Connecteur en t		X6	1/2
J2		Filet de sécurité	1800mm	X1	1/2
K		Pôle supérieur	1070mm	X6	2/2
L		Pôle inférieur	1070mm	X6	2/2
M		Clip	75mm	X12	1/2
N		Outil de montage		X1	1/2
O		Casquette		X6	1/2
P2		Corde	9,5 m	X1	1/2
Q2		Tige en fibre	101,5 cm	X8	1/2

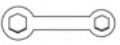















2023-2024

## LISTE DES PIÈCES DU TRAMPOLINE 12 FT

1210_134633					
A3		Support du châssis supérieur	1400mm	X8	1/3
B3		Tour de protection		X1	1/3
C3		Tapis de saut	3230mm	X1	2/3
D		Ressorts	145mm	X72	2/3
E		Rallonge des	510 mm	X8	3/3
F3		Pieds	1400mm	X4	1/3
G		Clip	45mm	X8	1/3
H		Outil pour le		X1	1/3
I		Connecteur en t		X8	2/3
J3		Filet de sécurité	1800mm	X1	2/3
K		Pôle supérieur	1070mm	X8	2/3
L		Pôle inférieur	1070mm	X8	2/3
M		Clip	75mm	X16	1/3
N		Outil de montage		X1	1/3
O		Casquette		X8	2/3
P3		Corde	11,5 m	X1	2/3
Q3		Tige en fibre	101 cm	X10	2/3

2023-2024

## LISTE DES PIÈCES DU TRAMPOLINE 14FT

1210_134634					
A4		Support du châssis supérieur	1620 mm	X8	1/3
B4		Tour de protection		X1	2/3
C4		Tapis de saut	3830mm	X1	1/3
D		Ressorts	145mm	X80	2/3
E		Rallonge des	510 mm	X8	3/3
F4		Pieds	1620 mm	X4	2/3
G		Clip	45mm	X8	2/3
H		Outil pour le montage		X1	2/3
I		Connecteur en t		X8	2/3
J4		Filet de sécurité	1800mm	X1	2/3
K		Pôle supérieur	1070mm	X8	3/3
L		Pôle inférieur	1070mm	X8	3/3
M		Clip	75mm	X16	2/3
N		Outil de montage		X1	2/3
O		Casquette		X8	2/3
P4		Corde	13,5 m	X1	2/3
Q4		Tige en fibre	100 cm	X12	2/3

2023-2024

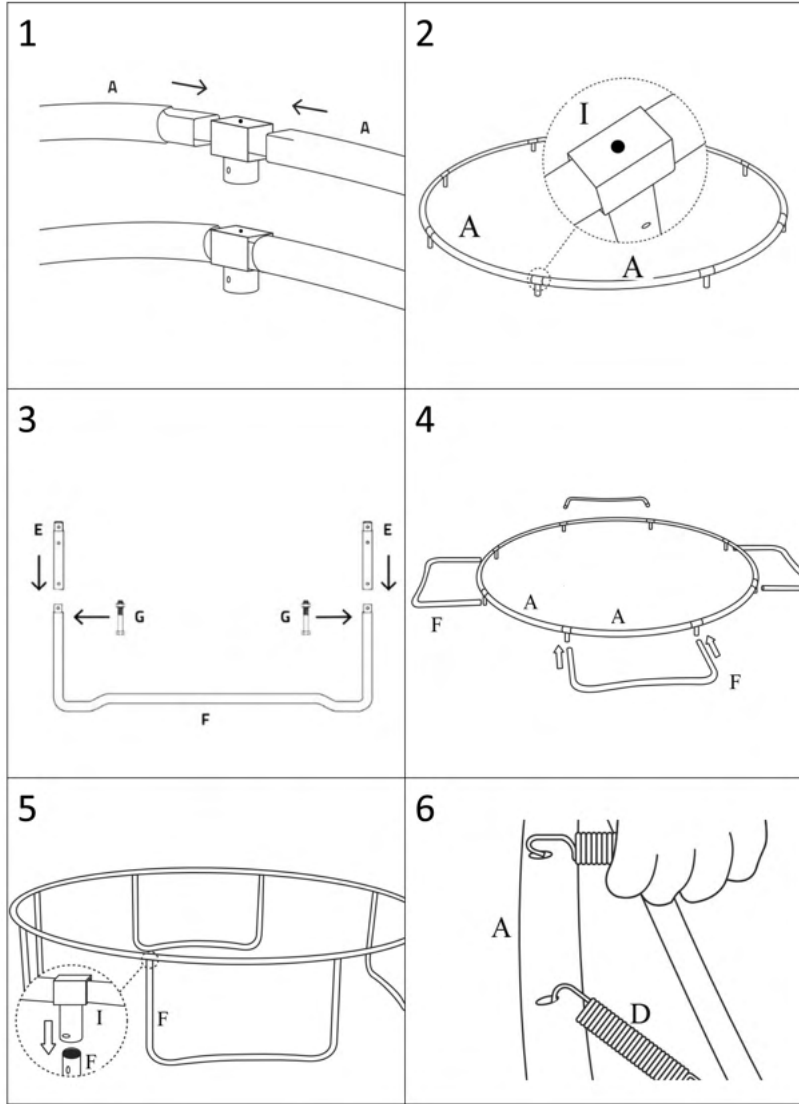



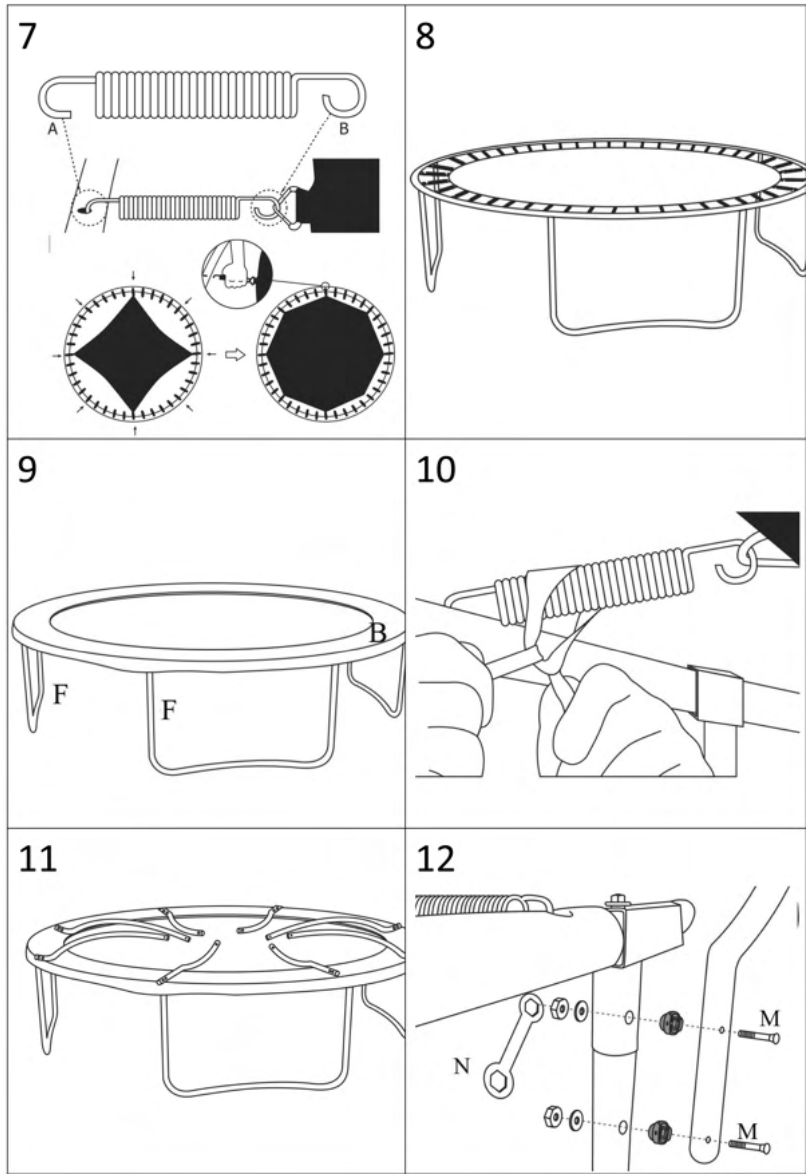

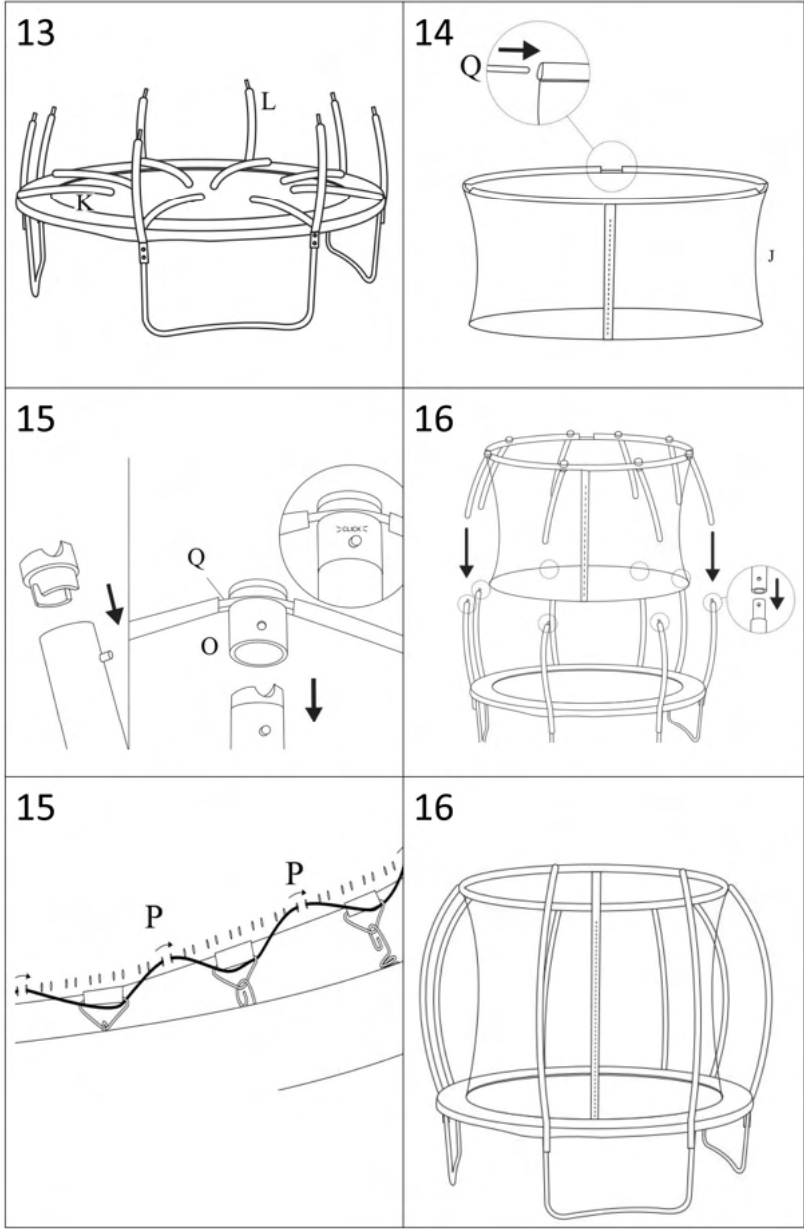

EN

**The use of trampoline is taken at your own risk! The operator is responsible only to the good condition of the trampoline!**

## INTRODUCTION

Before you begin to use this trampoline, you must read all the information in this manual. Just like any other type of physical recreational activities, participants can be injured. To reduce the risk of injury, make sure to follow the appropriate safety rules and tips.

- This manual is a part of the product. Therefore, keep this manual for future reference. In case you want to give the product to another person, please always give this manual.
- Misuse and abuse of this trampoline is dangerous and can cause serious injury or death!
- Trampolines are rebounding devices which propel the performer to unaccustomed heights through a variety of movements. So always use caution when playing on a trampoline.
- Always inspect the trampoline for stability before each use. Make sure no part is lost.
- Proper assembly, care and maintenance of product, safety tips, warnings, and proper techniques in jumping and bouncing are all included in this manual. All users and supervisors must read and familiarize themselves with these instructions. Anybody who chooses to use this trampoline must be aware of their own physical limitations and only perform jumps and bounces corresponding to their own abilities.

**Before the start of the training seek doctor advice if trampoline jumping is suitable for you.**

Initially, you should get accustomed to the feel and bounce of the trampoline. The focus must be on your body position and you should practice each fundamental bounce until you can do each skill with bounce before moving on to more difficult and advanced bounces. Do not bounce recklessly on the trampoline, emphasis must be made on good control and the mastering of various bounce techniques.

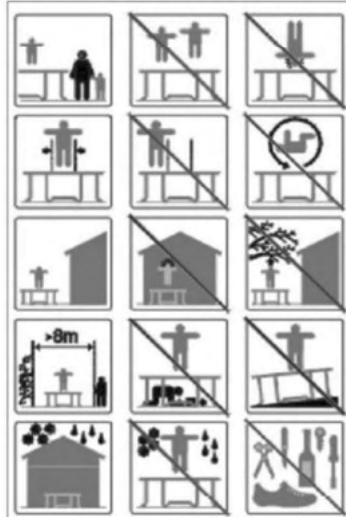

No more than one person is allowed on the trampoline! Multiple jumpers increase the risk of injury resulting from mid-air collisions.



Do not perform somersaults (flops) as this will increase the chances of landing on your head or neck. Paralysis or even death can result.

**TRAMPOLINE**

2023-2024

# ***GUIDELINES***

## **1. GENERAL INSTRUCTIONS**

### **1.1 PURPOSE**

- The product is intended for home/domestic use only and is not suitable for professional or medical uses.
- Maximum of weight capacity are: 80kg for 2.44M; 150 kg for 3,05M/ 3,66M/ 4,27M. The user's weight mustn't be over this limit. Otherwise, the warranty automatically cancels.

Model	Frame height	Safety net height	Total diameter	Total height including stand safety net
8FT	60cm	180cm	244cm	240cm
10FT	76cm	180cm	305cm	256cm
12FT	80cm	180cm	366cm	260cm
14FT	80cm	180cm	426cm	260cm

### **1.2 DANGER FOR CHILDREN**

- This trampoline is a toy. Do not let unsupervised children near this product. Carry out the necessary safety precautions and supervise all trampoline activities.
- Be aware that the packaging material is not suitable for children and ensure the packaging material is disposed properly. There is a danger of suffocation.
- Trampolines over 51cm (20inches) in height are not recommended for children under 6 years of age. Children cannot recognize potential dangers from this product. Keep children away from this product. The product has to be stored out of reach of children and pets.

### **1.3 ATTENTION – PRODUCT DAMAGES**

- Do not alter the product. Only use original spare parts. Repairs should only be carried out by qualified technicians. Improper repairs can compromise the safety of your trampoline. Use this product only as described in this manual.
- Protect the product against humidity and high temperatures.
- Note, always check the suitability for use of this product, for example checking for the parts that can be damaged.

#### **Parts can be damaged are:**

- Edge cover
- Fenders
- Jumping mat
- Safety-net
- Please note that the anti-slip properties of the jumping mat will reduce over time.

### **1.4 ADVICE FOR THE ASSEMBLY**

- The assembly of the product must be done carefully by at least two able-bodied adults. If in any doubt, ask a technically qualified person.
- Before you start assembling the trampoline, read all the instructions in this manual.

2023-2024

- Remove all packaging materials and lay down all parts on a free space. This gives you an overview and simplifies the assembly procedure.
- Check with the parts list that no parts are missing. Dispose of the packaging material when the assembly is completed.
- Beware that when using tools or doing technical work, there is always a risk of injury.
- Therefore assemble the product carefully.
- Create a danger free environment, for example: do not let tools lie around the work space.
- Store the packaging material in a way that cannot cause any danger. Foils and plastic bags are dangerous for children (danger of suffocation)!
- After installing the product according to the instruction manual, please make sure that all screws, bolts and nuts are correctly installed and tightened and that all joints are tightly fixed.
- A clearance space of at least 8m is necessary around the trampoline. An appropriated clearance must be kept between the trampoline and possible sources of danger, such as electric cables, tree branched, playing devices, swimming pools and fences.
- The trampoline must be set up properly before use.
- Never set up the trampoline in rainy, windy or stormy conditions, especially lightning conditions. It is recommended that the trampoline be taken apart and stored in bad weather.
- The metal frame of the trampoline will conduct electricity. Lightning, extension cords and all electrical equipment must never be allowed to come in contact with the trampoline.
- The trampoline must always be used in a well-lit area.
- Do not place any objects under the trampoline.
- Do not place the trampoline in the vicinity of other leisure devices.
- When assembling or disassembling, please use gloves to protect your hands.

**Additional notes**

**WARNING**

1. Please ensure that the safety enclosure net zipper is 100% closed and all three entrance hooks are re-hooked before jumping.
2. Do not intentionally jump into the safety net, it is only designed to stop persons from falling off the trampoline. Intentional jumping into the safety net may cause the trampoline to top over, or may damage your net. Abuse of the safety net is considered negligent use which is not covered by the warranty, please refer to the disclaimer.

**2. SAFETY INSTRUCTIONS FOR TRAMPOLINES**

- Warning: Require supervision by an adult!
- Warning: Not suitable for children under 3 years old. Choking hazard, small parts, sharp points and edges.
- Warning: Only one user at a time. Danger of collision!
- No somersaults or other difficult jumps
- Warning: Trampoline only for outside use, not suitable for indoor use!
- Warning: Empty your bags before boarding.



2023-2024

- Warning: Take off your shoes; or gym shoes with a thin sole are possible.
- Warning: Do not use if the jumping mat is wet.
- Warning: Always jump in the middle of the jump mat.
- Warning: Do not exit by a jump.
- Warning: Make a rest after 20min.
- Warning: Do not eat while jumping
- The trampoline is not intended to be buried into the ground
- All user of the trampoline need a supervisor. Regardless of the age and the experience of the user.
- The safety instructions of the trampoline should always be considered and obeyed.
- Somersaults must be avoided. Incorrect landings on the trampoline can lead to injuries, particularly to the back, neck or head. Injured may include paralysis. Or even death.
- Only one person should use the trampoline at a time. Multiple users on the trampoline will increase the risk of collision.
- The trampoline has to be examined for damaged, wearing or defective part before each usage, as it can impair the overall safety of the trampoline. The damaged wearing or defective parts should be replaced immediately. In the meantime the trampoline must be restricted from access.
- No clothes with hooks or parts may be carried when jumping on the trampoline, in order to avoid hooks getting caught.
- The trampoline must be set up only on a flat ground and non-slippery surfaces/
- Strong wind can blow the trampoline away. If strong winds are predicted. The trampoline must be moved to a protected place, and taken apart. Or fastened to the ground with cords and herrings. At least three anchorages are necessary. It is not enough to anchor the pennants in the ground since the can tear out of the patch cords.
- Try to avoid the moving the assembled trampoline, because it could bend during transportation. Should it be necessary to move the trampoline, please consider the following: at least four people must be evenly spaced around the frame to lift the trampoline off the ground. The trampoline must be carried horizontally, and if the frame shifts position use four people to draw the trampoline in shape.
- Trampoline are jumping devices, enabling the user to jump to unusual heights as well as into a multiplicity of body movements. Jumping into the trampoline. Hitting the frame, cover pads or incorrect landing on the trampoline can lead to injury.
- Users should be familiar with the user manual. This manual contains assembly instructions selected precautionary measures as well as recommendations for servicing and maintenance of the trampoline. In order to ensure a secured and fun use of the trampoline.
- It is the responsibility of the owner of the supervisor to guarantee that all users of the trampoline are informed sufficient space around it as a safety precaution.
- Never use it near water and keep sufficient space around it as a safety precaution.
- Beware of moving parts. Which could catch your arms and legs.
- Do not stick any foreign objects in to the trampoline,
- Do not allow anyone or any object to go under the trampoline whilst someone is jumping on the mat. The jumping mat is flexible and downwards force create by someone jumping can cause serious injury to a person.

- Implement all safety rules and make yourselves familiar with the information in the user manual
- The trampoline can be only used, if the jumping mat is clean and dry. Worn or damaged jumping mats should immediately be replaced.
- Object, which could be dangerous to the used, should be vacated from the area
- Avoid unauthorized and unsupervised use of the trampoline.
- Do not use the trampoline under influence of alcohol or drugs(inch medicines)
- Learn the fundamental jumping techniques thoroughly. Before trying difficult jumps. For more information. See section-fundamental bounce techniques.
- Climb on the trampoline. Do not jump on it directly. Do not use the trampoline as jump board for other articles. For more information, see section-accident categories: mounting and dismounting
- For further information or exercise documents, you can turn to a trained trampoline teacher.
- In winter, the snow load and the very low temperature can damage the trampoline. It is recommended to remove the snow and store the mat and the enclosure indoor. Always check the trampoline before each use !!

Nuts and bolts self-locking, must be replaced after 2 years!!

The safety net should also be replaced after 2 years !!

**Causes of accidents somersaults:** Somersaults must be avoided. Incorrect landings on the trampoline can lead to injuries, particularly to the back, neck or head. Injured may include paralysis. Or even death.

## **Possible accident causes**

### **Somersaults:**

Somersaults must be avoided. Incorrect landings on the trampoline can lead to injuries, particularly to the back, neck or head, including paralysis or even death. The user can also be injured by landing on the trampoline in an uncontrolled manner.

### **Multiple users:**

The risk of injuries is raised if several persons jump on the trampoline simultaneously and lose control of their bounces. The jumper can collide with each other, land improperly or fall off the trampoline. Usually, the smallest or lightest person is injured rather than a taller or heavier person.

### **Ascending and descending:**

Always ascend and descend carefully. Do not pull yourselves at the protection mat, do not march on the springs and do not jump on the trampoline from any higher place such as ladder, roof or terrace. Do not jump off the trampoline regardless of the nature of the ground around the trampoline. Small children possibly need help with ascending and descending the trampoline. Always hold on the frame when descending from the trampoline. Do not stand on the protection mat. When descending the trampoline move to the rim of the bounce mat, bend forward and hold on the frame. Then step on the ground or ladder.

### **Frame and springs:**

When bouncing on the trampoline keep to the center of the bounce mat in order to reduce the risk to be injured by landing on the frame or the springs. The springs and the frame must always be completely covered by the protection mat. Avoid to step on the protection mat as it is not designed to be stepped on.

### **Loss of control:**

Loosing control of the bounce can result in injuries by a improper landing on the bounce mat, the frame or the springs or by falling off the trampoline. A controlled bounce is characterized by the fact the person lands on the same place as he or she had jumped off. Learn the fundamental jumping techniques thoroughly before trying difficult jumps. The risk of injury is increased by fatigue of the person jumping or by effecting a bounce which is beyond the persons bouncing ability. Control can be regained by pulling the knees completely towards the body while landing.



**Drugs and alcohol:**

The risk of injury is increased under the influence of drugs and alcohol, as these substances will impair the reaction time, the judgment, the stereoscopic vision, the overall coordination and the motor function of a person.

**Foreign objects:**

Do not use the trampoline if there are pets, other persons or objects beneath the trampoline. Do not hold any objects while jumping on the trampoline and do not place any objects on the trampoline while a person is jumping. Remove all branches, cables etc. Which are above the trampoline.

**Poor maintenance:**

A poor maintenance of the trampoline raise the risk of injury. Check the trampoline for torn or worn bounce mats and protection mats, a bent frame or missing parts, loose or broken springs and the overall stability of the trampoline. Check the trampoline before each use and replace all missing parts immediately. The trampoline must not be used before it has been completely repaired.

**Poor weather conditions:**

Only use the trampoline in good weather conditions. A wet bouncing mat is slippery. The person jumping can loose control when jumping with strong winds.

**Unlimited access to the trampoline:**

Please store the ladder at a secure place when the trampoline is out of use in order to prevent children from an unsupervised access to the trampoline.

**Accident prevention:****The user's role with accident prevention:**

Basic knowledge of the trampoline is indispensable for security. All users of the trampoline must have been familiarized with the basic bounce and landing techniques before passing over to more sophisticated bounces. The user effects a controlled bounce when he jumps off and lands at the same place. For further details see paragraph "Basic bouncing techniques". For further information please contact a skilled trampoline coach.

**The supervisor's role:**

The supervising person must know all safety instructions and is responsible for their observance. If no appropriate supervision is possible the trampoline has to be dismantled and to be stored at a secure place. It has to be covered by a tarpaulin which is secured by a chain and a lock. The supervising person has to make sure that the users observe the safety instructions and the information sign is placed on the trampoline.

### **3.Important instruction for use**

The trampoline must only be used supervised, regardless of the bouncing abilities and the age of the user.

The person jumping has to master all basic bouncing techniques(see paragraph “basic bouncing techniques”).

The emphasis must be put on a controlled bouncing. The person jumping must not try to outdo another person.

Do not bounce too long. Fatigue can increase the risk of injury.

The user should wear appropriate clothing such as T-shirts, trunks and trainers with soft soles or jump barefoot.

We recommend that beginners wear long trunks and tops with long sleeves in order to prevent abrasions.

Please refer to the paragraph “ascending and descending” in paragraph “accident prevention”. Do not exert difficult bounces without being supervised by a skilled trampoline coach. Begin with easy bounces putting an emphasis on the bouncing technique rather than on the bouncing height. Never jump on the trampoline alone and unattended. See paragraph “basic bouncing techniques”.

### **4.Assembling the trampoline**

A clearance space of at least 8m is necessary above the trampoline. An appropriated clearance must be kept between the trampoline and possible sources of danger, such as electric cables, tree branches, playing devices, swimming pools and fences.

The trampoline must not be placed on hard surfaces such as asphalt, concrete, etc..

Please make sure that:

- 1.The trampoline has been placed on an even, solid and non-skid surface.
- 2.The place is well lit.
- 3.No disturbing objects are next to the trampoline.

### **5.Maintenance**

In order to maintain the safety standard of the trampoline it has to be checked regularly.

Defective parts such as connecting devices have to be replaced immediately. The trampoline must not be used before it has been completely repaired.

The trampolines are galvanized. Despite the galvanization there might be rust-streaked place at the connector points or under the protection covers. In order to avoid rust please lubricate the frame holes and the connecting devices regularly with petroleum jelly or another appropriate lubricant. This will increase the durability of the frame.

Regular maintenance is required. A neglect of regular maintenance can endanger the user. Observe the following instructions. It is particularly important that you follow the beginning of each season and periodically during the use season, the maintenance instructions. Check all nuts and bolts for tightness and tighten if necessary after this. Check that the ends of all springs are still intact and cannot come loose during use. Check all coverings for bolts and sharp edges. Replace them if necessary please. Do not make any changes on the trampoline. Use only original spare parts. Repairs should be performed only by qualified persons. Improper repairs may put the safety of the trampoline. Use this product only as described in this manual. A poorly maintained trampoline increases the risk of injury. Please check for torn or worn mats and cover mats, frame bent or missing parts, loose or broken springs, and overall stability of the trampoline. Before each use, the trampoline should be inspected. Worn or damaged parts must be replaced immediately. The trampoline must not be used until full recovery. If self-locking nuts or bolts are used, make sure that they are suitable only for single use and must be replaced

#### **6.Cleaning**

Wipe the trampoline with a soft cloth. Do not use an abrasive or other chemical detergents.

#### **7.Packing**

This trampoline is protected against transport damaged by an appropriate package. Most of the packing material is recyclable. Please dispose of it in an appropriate way.

**For dis-assembly, please follow the assembly instructions in reverse order.**

## Try the trampoline

After assembling the trampoline, it is imperative that they have the following safety checks:

### Checking the trampoline

- check with a screwdriver, to ensure that all screws are tightened
- check under the trampoline to make sure that all springs of the frame are hooked up to the jumping mat
- wiggle the trampoline and check the stability of the frame. The floor must be level.
- make sure that the springs and the frame are completely covered by cover mats and the and cover mat is secured with belts securely

### Checking the safety net

- check the support rods are fixed
- check the material and seams of the net and the inserted poles carefully. They must be impeccable.
- check the zipper for proper function.
- check suspended below the trampoline in the triangular-eyelets
- check whether all hooks are in the triangular-eyelets of the trampoline

## FUNDAMENTAL BOUNCES TECHNIQUES

Since the danger of injury is very high for inexperienced jumpers, it is important that they learn the basic jumping techniques.

All trampoline users are recommended to understand and perfect these fundamental bounces.

### THE BASE BOUNCE

- Start from a standing position, feet shoulder width apart with head and eyes on the mat.
- Swing your arms forward and up and around in a circular motion.
- Bring feet together while in mid-air and point toes downward.
- Keeping feet shoulder width apart when landing on mat.

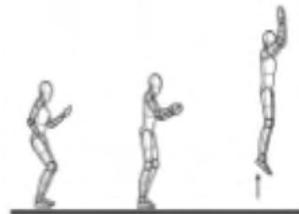

#### THE BRAKING MANOEUVRE

- Occasionally they may lose control of their jump and bounce wildly. Performing the braking maneuver will allow the user to regain control of the jump and their balance.
- Start with a basic bounce.
- As you land bend your knees sharply and this will allow you to stop your jump.



#### THE HANDS AND KNEES BOUNCE

- Start with a low controlled basic bounce.
- Land on your hands and knees keeping your back straight.
- Emphasis should be directed at a good four-point landing. And not on jumping height.



#### KNEE BOUNCE

- Start with a low controlled basic bounce.
- Land on your knees keeping back straight. Body erect and use your arms to maintain balance.
- Bounce back to the basic bounce position by swing your arm up.



















#### SEAT BOUNCE

- Land in a flat sitting position.
- Place hands on mat beside your hips.
- Return to erect by pushing with your hands.



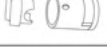















## 8FT TRAMPOLINE PARTS LIST

1210_134631					
A1		TOP RAIL	1220mm	x6	1/2
B1		COVER PAD		X1	1/2
C1		JUMPING MAT	2010mm	X1	1/2
D		SPRINGS	145mm	X48	1/2
E		LEG EXTENSION	/	/	
F1		LEG BASE	1200mmmm	X3	1/2
G		QUICK CLAMP	45mm	/	
H		SPRING FIXING TOOL		X1	1/2
I		T-CONNECTOR		X6	1/2
J1		SAFETY NET	1800mm	X1	1/2
K		UPPER POLE	1070mm	X6	2/2
L		LOWER POLE	1070mm	X6	2/2
M		QUICK CLAMP	75mm	X12	1/2
N		ASSEMBLY TOOL		X1	1/2
O		CAP		X6	1/2
P1		ROPE	7.7m	X1	1/2
Q1		FIBER ROD	104cm	X6	1/2











2023-2024

## 10FT TRAMPOLINE PARTS LIST

1210_134632					
A2		TOP RAIL	1500mm	x6	1/2
B2		COVER PAD		X1	2/2
C2		JUMPING MAT	2610mm	X1	1/2
D		SPRINGS	145mm	X60	2/2
E		LEG EXTENSION	510mm	X6	2/2
F2		LEG BASE	1500mm	X3	1/2
G		QUICK CLAMP	45mm	X6	1/2
H		SPRING FIXING		X1	1/2
I		T-CONNECTOR		X6	1/2
J2		SAFETY NET	1800mm	X1	1/2
K		UPPER POLE	1070mm	X6	2/2
L		LOWER POLE	1070mm	X6	2/2
M		QUICK CLAMP	75mm	X12	1/2
N		ASSEMBLY TOOL		X1	1/2
O		CAP		X6	1/2
P2		ROPE	9.5m	X1	1/2
Q2		FIBER ROD	101.5cm	X8	1/2

2023-2024















## 12FT TRAMPOLINE PARTS LIST

1210_134633					
A3		TOP RAIL	1400mm	X8	1/3
B3		COVER PAD		X1	1/3
C3		JUMPING MAT	3230mm	X1	2/3
D		SPRINGS	145mm	X72	2/3
E		LEG	510mm	X8	3/3
F3		LEG BASE	1400mm	X4	1/3
G		QUICK CLAMP	45mm	X8	1/3
H		SPRING FIXING		X1	1/3
I		T-CONNECTOR		X8	2/3
J3		SAFETY NET	1800mm	X1	2/3
K		UPPER POLE	1070mm	X8	2/3
L		LOWER POLE	1070mm	X8	2/3
M		QUICK CLAMP	75mm	X16	1/3
N		ASSEMBLY		X1	1/3
O		CAP		X8	2/3
P3		ROPE	11.5m	X1	2/3
Q3		FIBER ROD	101cm	X10	2/3

2023-2024

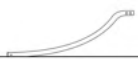

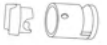
## 14FT TRAMPOLINE PARTS LIST

1210_134634					
A4		TOP RAIL	1620mm	X8	1/3
B4		COVER PAD		X1	2/3
C4		JUMPING MAT	3830mm	X1	1/3
D		SPRINGS	145mm	X80	2/3
E		LEG EXTENSION	510mm	X8	3/3
F4		LEG BASE	1620mm	X4	2/3
G		QUICK CLAMP	45mm	X8	2/3
H		SPRING FIXING		X1	2/3
I		T-CONNECTOR		X8	2/3
J4		SAFETY NET	1800mm	X1	2/3
K		UPPER POLE	1070mm	X8	3/3
L		LOWER POLE	1070mm	X8	3/3
M		QUICK CLAMP	75mm	X16	2/3
N		ASSEMBLY TOOL		X1	2/3
O		CAP		X8	2/3
P4		ROPE	13.5m	X1	2/3
Q4		FIBER ROD	100cm	X12	2/3

2023-2024

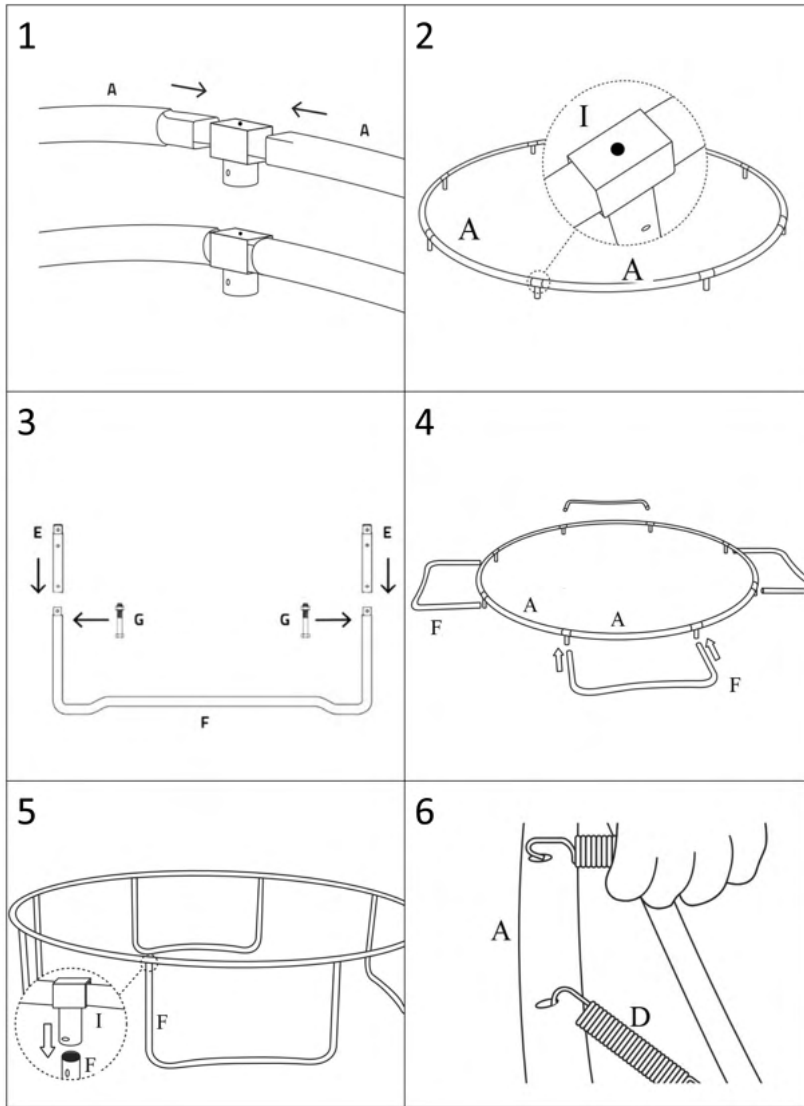

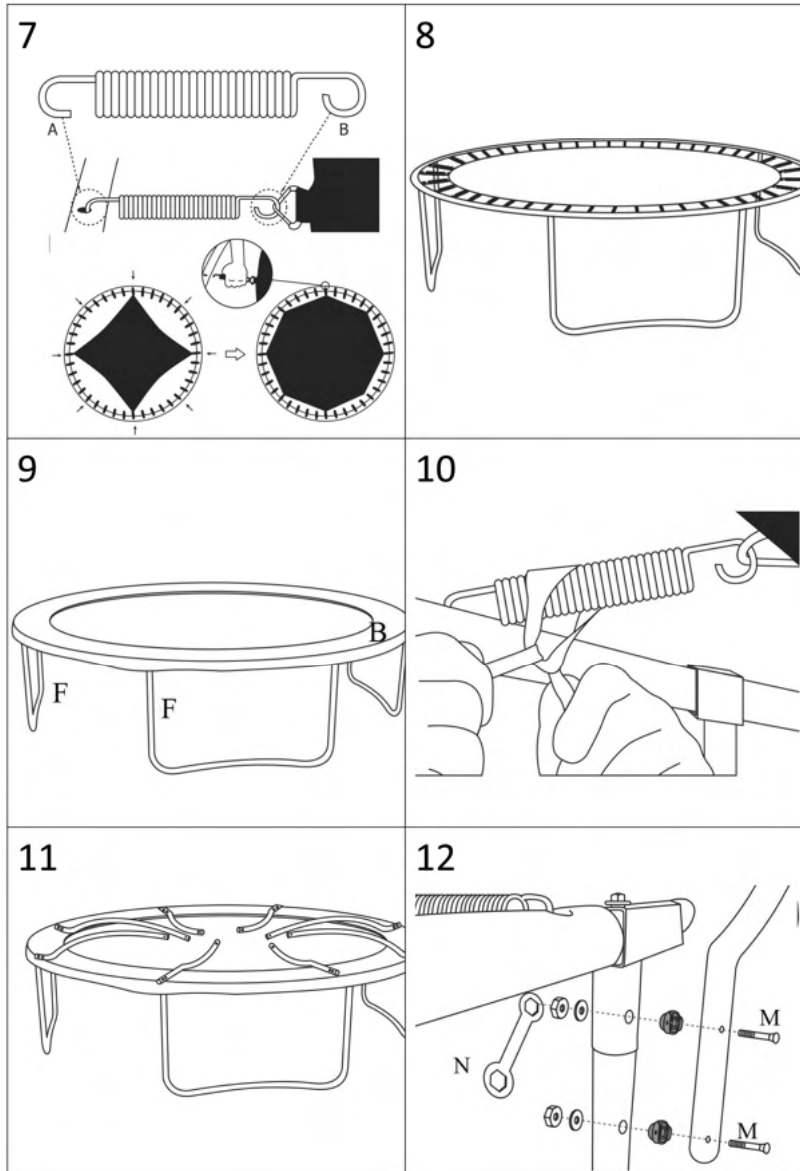

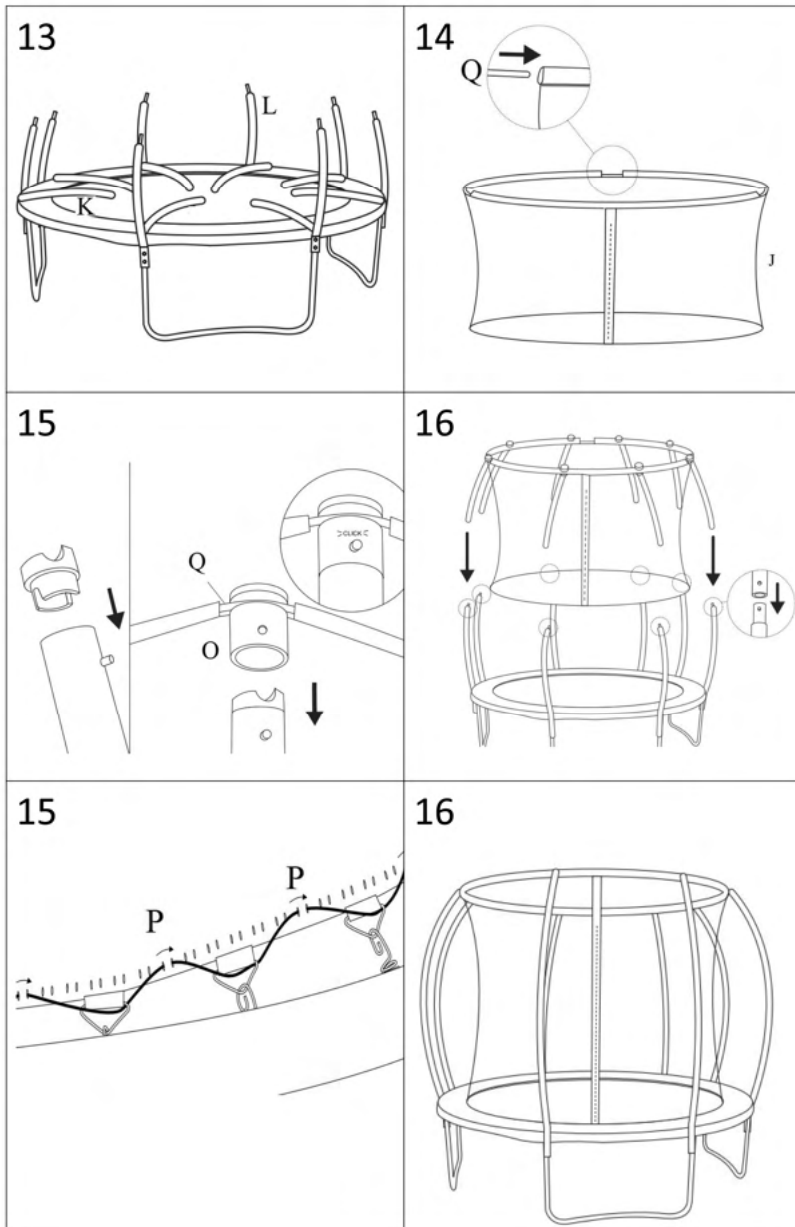

## ES

La utilización de este trampolín se hace bajo su propia responsabilidad. Usted es responsable del mantenimiento de su buena condición.

### INTRODUCCION

Antes de utilizar el trampolín, lea cuidadosamente el manual de usuario.

Como cualquier actividad física, el trampolín comprende ciertos riesgos. Para reducir estos riesgos, es necesario que seguir estas instrucciones.

- Este manual de usuario se considera parte del producto. Tiene que conservarlo ya que es una referencia. En el caso de que usted ceda el producto, no olvide incluir el manual.
- Un mal uso puede causar accidentes graves o mortales.
- El trampolín es un objeto que puede lanzarlo a alturas impresionantes. Es por eso que se recomienda una especial atención cuando lo utilice.
- Por favor, compruebe la estabilidad de la lona de salto antes de cada utilización y asegúrese de que no faltan piezas.
- Más adelante encontrará instrucciones sobre el montaje y el desmontaje del trampolín, indicaciones de seguridad e indicaciones sobre los tipos de saltos adecuados. Utilice solamente saltos que controle totalmente y tome en cuenta sus límites físicos.

Antes de empezar el uso del trampolín, consulte a un médico para saber si su estado de salud se lo permite.

Empiece por acostumbrar su cuerpo a los saltos y a los rebotes sobre el trampolín. Concéntrese en la posición de su cuerpo. Practique los saltos más simples antes de probar los más difíciles. No deje su cuerpo rebotar sin control sobre el trampolín, debe de tener un control perfecto de su cuerpo y de los diferentes tipos de salto.

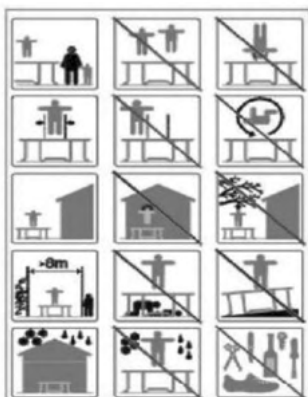

¡ No puede haber más de una persona sobre el trampolín !  
Más de una persona aumenta el riesgo de accidente o colisión.



Los saltos peligrosos pueden causar lesiones graves y parálisis de la nuca y de la columna vertebral. NUNCA haga saltos peligrosos...

2023-2024

## GUIA DEL TRAMPOLIN

### 1. INDICACIONES GENERALES

#### Utilización prevista.

Este producto ha sido diseñado para un uso doméstico. No puede ser utilizado con fines profesionales o terapéuticos.

La capacidad máxima de peso son: 80kg para 2.44M; 150kg para 3,05M / 3,66M / 4,27M. El peso del usuario no debe superar este límite. De lo contrario, la garantía se cancela automáticamente.

Modelo	Altura de la estructura	Altura de la red de seguridad	Diámetro total	Altura total (incluyendo la altura de la red de seguridad)
2,44m	60 cm	180 cm	244 cm	240 cm
3,05m	76 cm	180 cm	305 cm	256 cm
3,65m	80 cm	180 cm	366 cm	260 cm
4,25m	80 cm	180 cm	426 cm	260 cm

#### Peligro para los niños

- El trampolín no es un juguete. NUNCA deje a los niños sin supervisión de un adulto. Respete las reglas de seguridad y supervise cualquier actividad a proximidad del trampolín.
- Asegúrese que todo el embalaje ha sido retirado correctamente. Las bolsas de plástico representan un riesgo de asfixia.
- Los trampolines cuya altura supera 51 cm no están adaptados para niños menores de 6 años.
- Almacene el trampolín fuera del alcance de los niños y de los animales. Estos no miden el peligro que representa un trampolín.

#### Cuidado – En caso de avería

- No haga ninguna modificación al producto. Utilice únicamente piezas de recambio originales. Las reparaciones deben ser efectuadas por una persona calificada. Reparaciones mal realizadas pueden comprometer la seguridad del trampolín. Utilice este producto únicamente siguiendo las indicaciones de este manual. Proteja el trampolín de la humedad y de las temperaturas extremas. El mantenimiento minucioso del trampolín es esencial para la seguridad de los usuarios. Siempre verifique el buen estado de las piezas "consumibles".

#### Piezas "consumibles":

- Protección de resortes
- Postes para red de seguridad
- Lona de salto
- Red de seguridad

- Las propiedades antiderrapantes de la lona de salto se desgastan con el tiempo.

**Consejos de Montaje:**

- El trampolín debe ser cuidadosamente montado por dos adultos. Para más información, diríjase a un técnico calificado.
- Antes de iniciar el montaje lea atentamente el manual.
- Retire todo material de embalaje y disponga las piezas en el suelo. Esto le permitirá tener una mejor vista global de todas las piezas que ha recibido.
- Asegúrese que tiene todas las piezas necesarias para el montaje.
- Toda manipulación manual es potencialmente peligrosa y puede presentar un riesgo de accidente. Le aconsejamos ser prudente al momento del montaje.
- No deje las herramientas en cualquier lado. Ponga todo el material de embalaje fuera del alcance de los niños (peligro de asfixia). Deshágase de estos embalajes de manera apropiada.
- Después de haber instalado el trampolín verifique que todos los tornillos y tuercas han sido instalados correctamente.
- Un espacio de por lo menos 8 m al rededor del trampolín es necesario. Debe de haber una gran distancia entre el trampolín y cualquier fuente de peligro (cables eléctricos, ramas de árboles, áreas de juego, piscinas, vallas, etc.)
- Verifique que el trampolín ha sido ensamblado correctamente antes de utilizarlo.
- Compruebe las condiciones meteorológicas antes de cada utilización del trampolín. Una lona de salto húmeda es resbaladiza y puede causar accidentes. Utilizar el trampolín en tiempos de fuertes vientos puede provocar una pérdida de control.
- La estructura de metal puede conducir la electricidad. Ningún equipo eléctrico no debe estar en contacto con el trampolín.
- El trampolín debe ser utilizado sobre una superficie plana.
- No ponga ningún objeto por debajo del trampolín.
- Al momento del montaje y del almacenamiento del trampolín le aconsejamos usar guantes de protección.

**Informaciones complementarias**

Cuidado
<ol style="list-style-type: none"><li>1. Asegúrese que la cremallera esté bien cerrada y que los tres clips de fijación estén correctamente fijados.</li><li>2. No se lance hacia la red de protección de manera intencional. La red de seguridad está diseñada para evitar que los usuarios caigan del trampolín. Saltar intencionalmente sobre la red de seguridad puede provocar que el trampolín se vuelque y se dañe. Este tipo de daños de la red de seguridad es considerado como una negligencia y anula la garantía.</li></ol>

**Consejos de seguridad:**

- Cuidado: El uso del trampolín necesita la supervisión del usuario por otra persona. De preferencia un adulto.
- Cuidado: No se aconseja para menores de 3 años. Este trampolín tiene piezas pequeñas que estar fuera del alcance de los niños.

- Cuidado: No puede haber más de una persona sobre el trampolín a la vez. Riesgo de colisión.
- Cuidado: No haga saltos peligrosos, con el fin de evitar heridas graves, mortales o parálisis de la nuca y la columna vertebral.
- Cuidado: Este producto está diseñado únicamente para una utilización exterior.
- Cuidado: Vacíe sus bolsillos antes de utilizar el trampolín.
- Cuidado: Le aconsejamos utilizar ropa y zapatillas de deporte o saltar sin zapatos.
- Cuidado: Cualquier prenda con ganchos no debe ser utilizada mientras salta en el trampolín.
- Cuidado: No utilice el trampolín si la lona de salto esta mojada.
- Cuidado: Siempre salte en el centro de la lona.
- Cuidado: No coma mientras salta.
- El trampolín está diseñado para anclarse al suelo.
- Siempre siga escrupulosamente las instrucciones de uso.
- Antes de cada utilización verifique el trampolín para asegurarse que ninguna pieza esta averiada. Si encuentra alguna pieza averiada, replácela inmediatamente y mientras tanto no utilice el trampolín.
- Los vientos violentos pueden dañar el trampolín. Le aconsejamos almacenarlo en un lugar protegido en caso de previsiones meteorológicas desventajosas. También puede anclarlo al suelo.
- Evite desplazar el trampolín cuando está totalmente montado. Si es necesario desplazarlo siga las siguientes recomendaciones: al menos cuatro personas deben desplazar el trampolín; tiene que estar a todo momento en posición horizontal; si la estructura cambia de posición reajuste la posición de las cuatro personas para regresar a una posición horizontal.
- Los usuarios del trampolín deben obligatoriamente leer el manual antes de utilizarlo.
- Es responsabilidad del propietario del trampolín informar a los usuarios de las reglas de seguridad.
- Nunca utilice el trampolín cerca de una fuente de agua y respete un espacio suficiente alrededor.
- Tenga cuidado con las piezas móviles, podría herirse un brazo o una pierna.
- No pegue ningún objeto sobre el trampolín.
- No ponga ningún objeto o persona bajo el trampolín.
- La lona de salto es flexible y la fuerza ejercida hacia el suelo ocasionada por los saltos del usuario pueden herir a la persona que se encuentra por debajo.
- Familiarícese con las consignas de seguridad presentes en este manual.
- El trampolín debe ser utilizado únicamente si la lona de salto está limpia y seca; una lona de salto usada o dañada debe ser cambiada inmediatamente.
- Los objetos peligrosos deben ser retirados del espacio reservado al trampolín.
- Evite un uso del trampolín no autorizado ni sin supervisión.
- No utilice el trampolín bajo las influencias del alcohol o de drogas (o cualquier medicamento que provoque somnolencia o disminución de los reflejos).
- Comience con saltos fáciles antes de practicar los difíciles.
- Le recomendamos insistentemente subir al trampolín con ayuda de la escalera y no saltando directamente sobre la lona. No haga rebotar ningún objeto sobre la lona.
- Para más información sobre los ejercicios y saltos que puede efectuar con su trampolín acérquese a un profesional certificado.
- En época de invierno, la nieve y las bajas temperaturas pueden dañar el trampolín. Le aconsejamos retirar la nieve y almacenar la lona y la red de seguridad en un lugar cerrado.
- Siempre verifique el estado de su trampolín antes de cada utilización.

2023-2024



Los tornillos deben ser cambiados todos los 2 años. La red de seguridad también.

**Los saltos peligrosos:** deben ser completamente evitados. Un aterrizaje fallido puede provocar accidentes graves. Sobre todo al nivel de la columna vertebral, de la nuca y de la cabeza. Estos accidentes pueden provocar una parálisis o la muerte.

**Prevención de accidentes graves:**

**Saltos peligrosos y volteretas :**

Nunca realice saltos peligrosos y volteretas (hacia adelante, hacia atrás) para evitar accidentes graves, mortales o paralizantes de la nuca y de la columna vertebral.

**Varias personas:**

El riesgo de accidente es más grande si varias personas saltan al mismo tiempo sobre el mismo trampolín. Sobre todo sin controlar los saltos. Los usuarios pueden chocar unos con otros o caer del trampolín. Es generalmente la persona más ligera quien se hace más daño.

**Subir y bajar:**

Siempre suba al trampolín con prudencia. Cuando suba al trampolín evite sujetarse de la red de seguridad, no camine sobre los resortes y no salte sobre el trampolín a partir de otros objetos más altos para evitar accidentes. Puede ser necesario ayudar a los niños a subir a bajar del trampolín. Siempre apóyese de la estructura cuando baje del trampolín. Cuando baje del trampolín agáchese y sujétese del borde de la estructura. Y después baje utilizando la escalera.

**Estructura y resortes:**

Cuando salte sobre el trampolín aterrice en el centro de la lona para evitar tocar la estructura y los resortes. Los resortes y la estructura deben siempre estar completamente cubiertos con la protección para resortes. Evite caminar sobre esta protección ya que no está diseñado para este efecto.

**Pérdida de control:**

La pérdida de control sobre un trampolín puede provocar una mala recepción sobre la lona de salto, la estructura o los resortes. Un salto controlado es cuando el usuario aterriza en el mismo punto donde salto. Aprender los saltos fundamentales antes de intentar los saltos más complicados. El riesgo de accidentes es más importante cuando el usuario está cansado.

**Drogas y alcohol:**

El producto no debe ser utilizado por personas bajo la influencia de drogas o alcohol. Estas sustancias pueden distorsionar la visión, la apreciación, el tiempo de reacción, la coordinación y los reflejos motores del usuario.

**Objetos que no pertenecen al kit:**

No utilice el trampolín si hay un perro o personas debajo. No sujete ningún objeto al momento de saltar. Retire todo todos los cables o conexiones que se encuentren bajo el trampolín.

**Mal mantenimiento:**

Un mal mantenimiento del trampolín aumenta los riesgos de accidentes. Verifique que la lona de salto este en buen estado antes de cada utilización. Verifique que ningún resorte esta averiado o ausente así como la estabilidad del trampolín. Si constata una avería remplace inmediatamente la pieza averiada. El trampolín no debe ser utilizado si esta averiado.

**Malas condiciones meteorológicas:**

Utilice el trampolín únicamente si las condiciones meteorológicas son favorables. Una lona de salto mojada será forzosamente resbaladiza. Con vientos fuertes el usuario puede perder el control.

**Acceso limitado al trampolín:**

Conserve la escalera en un lugar seguro cuando el trampolín no está en uso. Esto permitirá evitar que los niños utilicen el trampolín sin supervisión de un adulto.

**Prevención de accidentes:****El papel del usuario:**

Un conocimiento mínimo del trampolín es necesario para utilizarlo. Cualquier usuario deber estar familiarizado con los fundamentos de los saltos.

**El papel del supervisor:**

El supervisor deber estar al corriente de las instrucciones de seguridad y verificar que sean respetadas. Si la supervisión de las actividades con el trampolín no puede efectuarse entonces este tiene que ser desmontado para ser almacenado en un lugar seguro con un acceso limitado por una cerradura o un candado. El supervisor debe también hacer respetar las reglas de seguridad sobre el trampolín.

**Consejos de utilización:**

El trampolín debe ser utilizado únicamente bajo supervisión sin importar las aptitudes del usuario. La persona que utiliza el trampolín debe conocer las técnicas de salto básicas. Debe controlar sus saltos. No salte demasiado tiempo. La sensación de fatiga aumenta el riesgo de accidentes. Recomendamos a los principiantes utilizar mangas largas para evitar las abrasiones.

**Montaje del trampolín:**

Un espacio de al menos 8 metros debe estar disponible alrededor del trampolín. Debe de haber una distancia apropiada entre el trampolín y cualquier fuente de peligro (cables eléctricos, ramas de árboles, accesorios de juegos, piscinas y vallas).

El trampolín debe ser instalado sobre una superficie dura como hormigón, etc.

**Por favor asegúrese que:**

1. El trampolín se encuentra sobre una superficie plana y sólida.
2. Que esté instalado en un lugar bien iluminado.
3. Ningún objeto se encuentra cerca del trampolín.

### Técnicas de salto.

Dado que el riesgo de accidente es muy importante para los principiantes, es primordial que aprendan las técnicas fundamentales.

Aconsejamos a todos los usuarios conocer perfectamente los saltos fundamentales.

#### **Salto Básico:**

- Empiece poniéndose de pie. Separe los pies con una separación igual a la distancia de sus hombros y la cabeza en dirección del salto
- Mueva los brazos hacia adelante y hacia arriba.
- Salte con los pies juntos y de punta.
- Aterrice separando los pies con una separación igual a la distancia de sus hombros



#### **Interrupción de los saltos:**

Puede suceder que el usuario pierda el control durante el salto. Para retomar el control y el equilibrio siga estas instrucciones:

Al momento de aterrizar, doble las rodillas lo máximo posible. Esto le permitirá interrumpir el salto.



#### **Salto de mano y rodilla:**

Empiece con un salto básico bajo y controlado.

Aterrice sobre las manos y rodillas y conserve la espalda recta.

Tenga mucho cuidado en el aterrizaje de estos 4 puntos de apoyo.



**Salto de rodillas:**

Empiece con un salto básico bajo. Aterrice sobre las rodillas y conserve la espalda recta. Después manténgase parado y conserve el equilibrio. Regrese a la posición inicial moviendo los brazos.



















**Salto sentado:**

Aterrice sentado con las piernas extendidas hacia el frente. Durante el aterrizaje coloque las palmas de las manos viendo hacia la lona de cada lado del cuerpo a la altura de la cadera. Regrese a la posición vertical (parado) apoyándose sobre las manos.



## LISTA DE PIEZAS DE TRAMPOLÍN DE 8 PIES

1210_134631					
A1		Soporte del chasis	1220 mm	x6	1/2
B1		Protección de los		X1	1/2
C1		Lona de salto	2010 mm	X1	1/2
D		Resortes	145mm	X48	1/2
E		Extensión de los pies	/	/	
F1		Pies	1200mm	X3	1/2
G		Clip	45mm	/	
H		Gancho		X1	1/2
I		Conector en t		X6	1/2
J1		Red de seguridad	1800 mm	X1	1/2
K		Barra superior	1070 mm	X6	2/2
L		Barra inferior	1070 mm	X6	2/2
M		Clip	75mm	X12	1/2
N		Herramienta de apretar		X1	1/2
O		Gorra		X6	1/2
P1		Soga	7,7m	X1	1/2
Q1		Varilla de fibra	104cm	X6	1/2





2023-2024

**LISTA DE PIEZAS DE TRAMPOLÍN DE 10 PIES**

<b>1210_134632</b>					
<b>A2</b>		Soporte del chasis	1500 mm	x6	1/2
<b>B2</b>		Protección de los		X1	2/2
<b>C2</b>		Lona de salto	2610 mm	X1	1/2
<b>D</b>		Resortes	145mm	X60	2/2
<b>E</b>		Extensión de los	510 mm	X6	2/2
<b>F2</b>		Pies	1500 mm	X3	1/2
<b>G</b>		Clip	45mm	X6	1/2
<b>H</b>		Gancho		X1	1/2
<b>I</b>		Conector en t		X6	1/2
<b>J2</b>		Red de seguridad	1800 mm	X1	1/2
<b>K</b>		Barra superior	1070 mm	X6	2/2
<b>L</b>		Barra inferior	1070 mm	X6	2/2
<b>M</b>		Clip	75mm	X12	1/2
<b>N</b>		Herramienta de apretar		X1	1/2
<b>O</b>		Gorra		X6	1/2
<b>P2</b>		Soga	9,5m	X1	1/2
<b>Q2</b>		Varilla de fibra	101,5 cm	X8	1/2

2023-2024

## LISTA DE PIEZAS DE TRAMPOLÍN DE 12 PIES

1210_134633					
A3		Soporte del	1400 mm	X8	1/3
B3		Protección de		X1	1/3
C3		Lona de salto	3230 mm	X1	2/3
D		Resortes	145mm	X72	2/3
E		Extensión de	510 mm	X8	3/3
F3		Pies	1400 mm	X4	1/3
G		Clip	45mm	X8	1/3
H		Gancho		X1	1/3
I		Conector en t		X8	2/3
J3		Red de	1800 mm	X1	2/3
K		Barra superior	1070 mm	X8	2/3
L		Barra inferior	1070 mm	X8	2/3
M		Clip	75mm	X16	1/3
N		Herramienta de apretar		X1	1/3
O		Gorra		X8	2/3
P3		Soga	11,5m	X1	2/3
Q3		Varilla de fibra	101cm	X10	2/3

2023-2024

**LISTA DE PIEZAS DE TRAMPOLÍN DE 14 PIES**

<b>1210_134634</b>					
<b>A4</b>		Soporte del chasis	1620 mm	X8	1/3
<b>B4</b>		Protección de los		X1	2/3
<b>C4</b>		Lona de salto	3830 mm	X1	1/3
<b>D</b>		Resortes	145mm	X80	2/3
<b>E</b>		Extensión de los	510 mm	X8	3/3
<b>F4</b>		Pies	1620 mm	X4	2/3
<b>G</b>		Clip	45mm	X8	2/3
<b>H</b>		Gancho		X1	2/3
<b>I</b>		Conector en t		X8	2/3
<b>J4</b>		Red de seguridad	1800 mm	X1	2/3
<b>K</b>		Barra superior	1070 mm	X8	3/3
<b>L</b>		Barra inferior	1070 mm	X8	3/3
<b>M</b>		Clip	75mm	X16	2/3
<b>N</b>		Herramienta de apretar		X1	2/3
<b>O</b>		Gorra		X8	2/3
<b>P4</b>		Soga	13,5m	X1	2/3
<b>Q4</b>		Varilla de fibra	100cm	X12	2/3

2023-2024



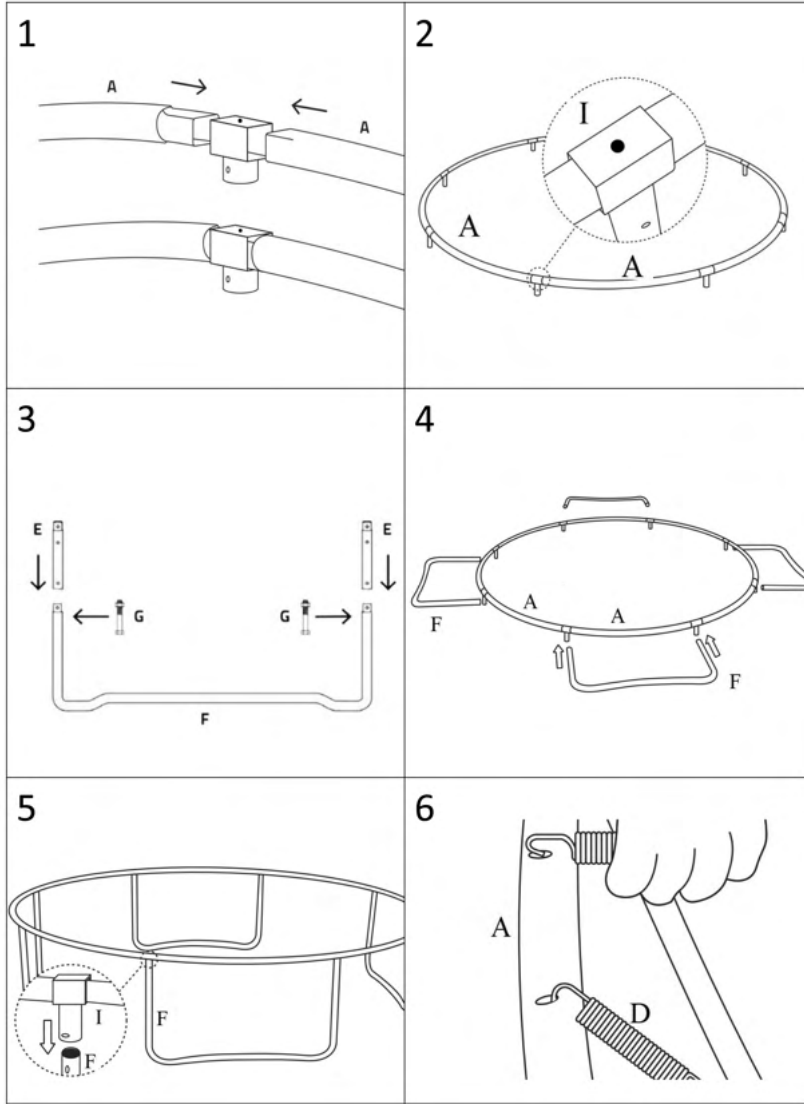

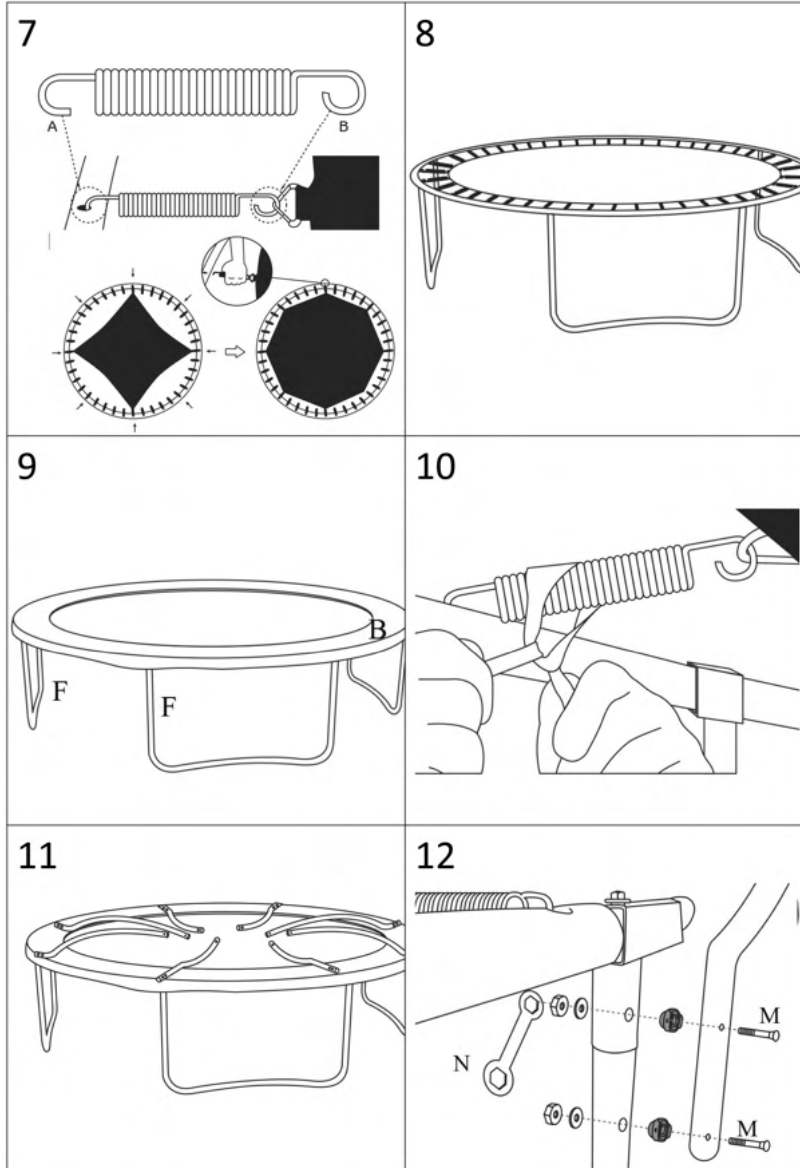

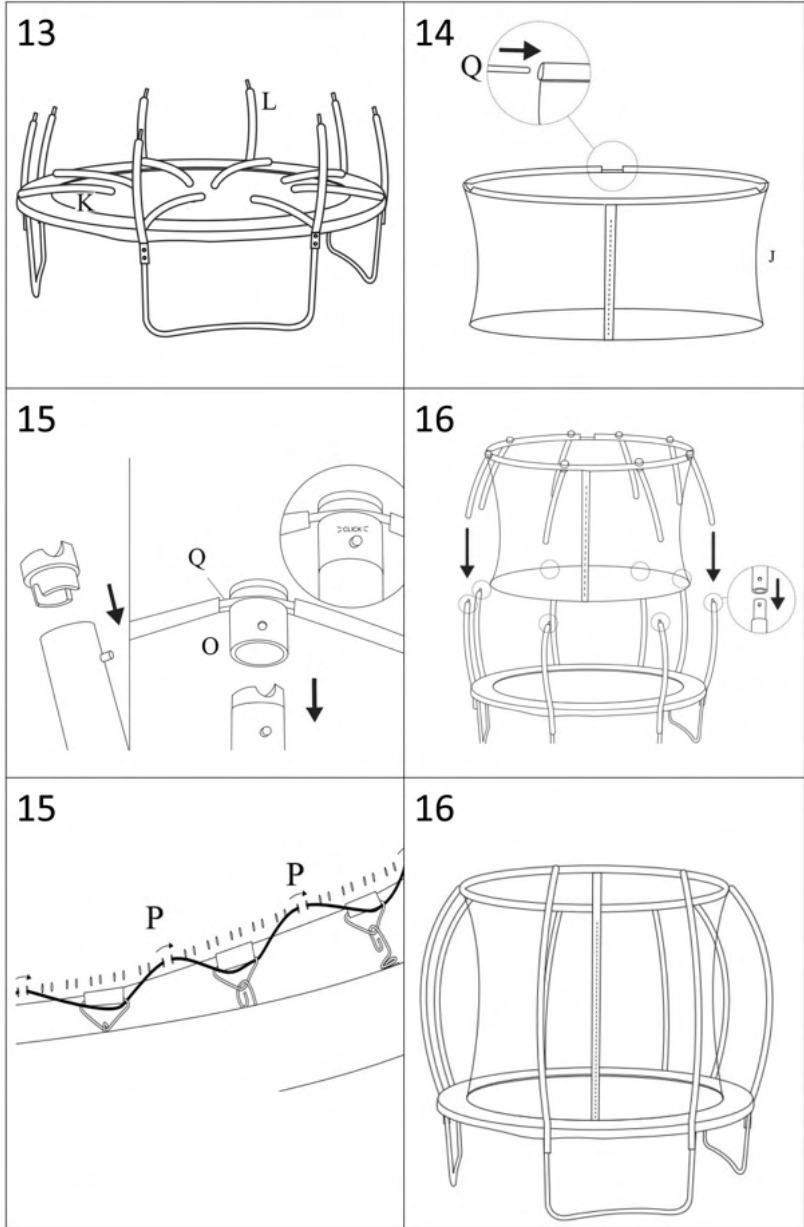

## IT

L'utilizzazione e i rischi che si possono incontrare con questo trampolino sono sotto la vostra responsabilità. Siete responsabili di mantenere la buona condizione del trampolino.

### INTRODUZIONE

Prima di utilizzare il trampolino, leggere attentivamente il preavviso.

Come ogni attività fisica, ci sono dei rischi con il trampolino. Per ridurre questi rischi è indispensabile che le istruzioni seguenti siano osservate.

- Questo preavviso fa parte integrante del prodotto. Dovete conservarlo perché vi serva di riferimento se bisogno. Nel caso dove cedete il trampolino, non dimenticarvi di dare il preavviso.
- Male utilizzare il trampolino può risultare in incidenti gravi o mortali.
- Il trampolino è un oggetto che è in grado di fare rimbalzare una persona a delle altezze impressionanti. Dunque un'attenzione particolare è raccomandata quando si usa il trampolino.
- Dovete verificare la stabilità del tappeto di salto prima ogni utilizzazione e controllare che nessuna parte sia mancante.
- Potete trovare qui sotto le istruzioni di montaggio e di smantellamento del trampolino, le indicazioni di sicurezza e le indicazioni sulle tecniche di salto adatte. Utilizzare solo le tecniche di salto che sapete fare e prendere in considerazione le vostre limitazioni fisiche.

Prima di cominciare ad utilizzare il trampolino bisogna consultare un medico per sapere se il vostro stato di salute lo permette.

Cominciare ad abituare il suo corpo ai salti e al rimbalzo del trampolino. Bisogna concentrarsi sulla posizione del corpo. Allenarsi con i salti più semplici prima di provare quelli più difficili. Non rimbalzare senza avere il controllo, bisogna potere controllare il suo corpo e le varie tecniche di salto.

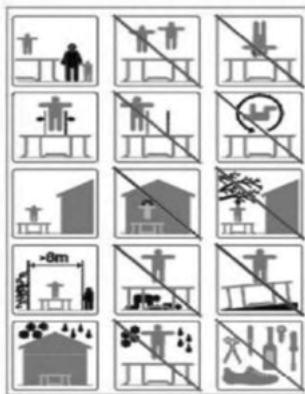

Non ci devono essere più di una persona alla volta sul trampolino! La presenza di più di una persona aumenta il rischio di collisione o d'incidente.



I salti mortali possono causare delle ferite importanti e paralizzanti del collo e della spina dorsale. MAI PROVARE DI FARE UN SALTO MORTALE...

2023-2024

## GUIDA DEL TRAMPOLINO

### 1. INDICAZIONI GENERALI

#### Uso previsto

Questo prodotto è stato concepito solo per l'uso domestico. Non può essere usato per uno scopo professionale o medicale.

La capacità massima di peso è: 80kg per 2,44M; 150kg per 3,05M / 3,66M / 4,27M.

Il peso dell'utente non deve superare questo limite. In caso contrario, la garanzia si annulla automaticamente.

MODELLO	ALTEZZA DEL TELAIO	ALTEZZA DELLA RETE DI SICUREZZA	DIAMETRO TOTALE	ALTEZZA TOTALE (COMPRESO ALTEZZA DELLA RETE DI SICUREZZA)
2,44m	60 cm	180 cm	244 cm	240 cm
3,05m	76 cm	180 cm	305 cm	256 cm
3,65m	80 cm	180 cm	366 cm	260 cm
4,25m	80 cm	180 cm	426 cm	260 cm

#### Pericolo per i bambini

- Il trampolino è un giocattolo. MAI lasciare dei bambini vicino senza controllo. Assicurarsi che le precauzioni di sicurezza siano rispettate e bisogna controllare tutte le attività che si trovano vicino al trampolino.
- Verificare che tutto l'imballaggio sia completamente tolto. I sacchi di plastica presentano un pericolo di asfissia.
- I trampolini di cui l'altezza supera i 51cm non sono adatti per i bambini che hanno meno di 6 anni.
- Tenere il trampolino lontano dai bambini e dagli animali. Infatti non hanno la nozione del pericolo che può rappresentare il trampolino.

#### Attenzione – in caso di danno

- Non modificare il prodotto. Usare solo i pezzi di ricambio originali. Le riparazioni devono essere fatte solo da una persona qualificata. Delle riparazioni fatte male possono compromettere la sicurezza del trampolino. Usare questo prodotto solo come è indicato nel manuale. Proteggere il trampolino dall'umidità e dalle temperature troppo calde. Notate che la manutenzione del trampolino è essenziale per la sicurezza degli utenti. Sempre verificare la viabilità dei pezzi che possono essere dannegianti.

#### **Parti dannegianti**

- Collare di protezione
- Barriera di sicurezza
- Tappeto di salto
- Rete di sicurezza
- Notare che le proprietà antiscivolo del tappeto di salto se ne vanno con il tempo

#### **CONSIGLI DI MONTAGGIO:**

- Il trampolino deve essere montato attentivamente da due persone adulte. Per avere più informazioni bisogna chiedere i servizi di una persona più qualificata.
- Prima di cominciare il montaggio, leggere attentivamente il manuale.
- Togliere tutte le materie d'imballo e presentare tutti i pezzi per terra, per avere una panoramica di tutte le parti che avete.
- Assicuratevi di avere tutti i pezzi per il montaggio.
- Tutta apertura manuale può essere pericolosa e può presentare dei rischi d'incidenti. Vi raccomandiamo di essere prudenti durante il montaggio.
- Non lasciare i vostri attrezzi dappertutto. Mantenere ogni materiale d'imballo lontano dai bambini (pericolo d'asfissia!). Buttare l'imballo in un posto appropriato.
- Dopo avere installato il trampolino bisogna verificare che tutte le viti siano state messe correttamente.
- Uno spazio libero di 8 metri è necessario intorno al trampolino. Infatti ci deve essere una grande distanza tra il trampolino e tutti i pericoli potenziali (cavi elettrici, alberi, piscine, cloture...)
- Verificare che il trampolino sia correttamente assemblato prima di utilizzarlo.
- Bisogna fare attenzione alle condizioni meteorologiche prima ogni utilizzazione del trampolino. Un tappeto di salto umido e che scivola può causare incidenti. Usare il trampolino quando c'è vento forte vi può fare perdere il controllo.
- La struttura di metallo può condurre l'elettricità. Nessun oggetto elettrico deve entrare in contatto con il trampolino.
- Il trampolino deve essere utilizzato su una superficie piatta.
- Non mettere nessun oggetto sotto il trampolino.
- Durante il montaggio e quando si deve sistemare il trampolino è consigliato di portare dei guanti.

Ulteriori informazioni

#### ATTENZIONE

1. Assicurarsi che la chiusura sia completamente chiusa e che i tre clips di chiusura siano correttamente fissati.
2. Non saltare sulla rete di sicurezza volontariamente. È stata concepita per evitare che gli utenti cadano dal trampolino. Saltare sulla rete di sicurezza può rovesciare il trampolino e può danneggiarlo. Questo tipo di danno sulla rete di sicurezza è considerato come una negligenza e non dà diritto alla garanzia.

#### CONSIGLI DI SICUREZZA:

- Attenzione: L'uso di questo trampolino richiede che una persona adulta sia presente per controllare l'utente.
- Attenzione: Non è adatto ai bambini che hanno meno di tre anni. Questo trampolino ha dei piccoli pezzi che devono essere tenuti lontano dai bambini piccoli.
- Attenzione: Ci deve essere solo una persona alla volta sul trampolino. Pericolo di collisione.
- Attenzione: Non fare salti mortali per evitare ferite serie, mortali o paralizzanti del collo e della spina dorsale.
- Attenzione: Questo prodotto è concepito solo per l'uso esterno.
- Attenzione: Svuotare le tasche prima di utilizzare il trampolino.
- Attenzione: Vi raccomandiamo di mettere vestiti di sport e di mettere delle scarpe di sport o di saltare piedi scalzi.
- Attenzione: Tutti i vestiti con ganci non devono essere utilizzati durante l'utilizzazione del trampolino.
- Attenzione: Non usare il trampolino se il tappeto di salto è bagnato.
- Attenzione: Sempre saltare in mezzo al trampolino
- Attenzione: Non uscire dal trampolino con un salto
- Attenzione: Non saltare e mangiare allo stesso tempo.
- Il trampolino non è stato concepito per essere incastrato sotto terra.
- Sempre seguire attentamente le istruzioni del manuale.
- Prima ogni utilizzazione verificare attentamente il trampolino per assicurarsi che nessuna parte sia danneggiata. Se ci sono pezzi danneggiati bisogna cambiarli subito e non usare il trampolino mentre aspettate i pezzi di ricambio.

2023-2024

55

- Il vento forte può danneggiare il trampolino. Vi consigliamo di metterlo al riparo nel caso di previsioni meteorologiche svantaggiose. Potete anche fissarlo al suolo con delle corde.
- Evitare di spostare il trampolino quando è montato. Se è necessario spostarlo, prendere in considerazione i consigli seguenti: almeno quattro persone devono spostare il trampolino; deve sempre essere mantenuto nella posizione orizzontale; se la struttura cambia di posizione bisogna rimpiazzare le persone in modo che la struttura sia orizzontale.
- Gli utenti del trampolino devono assolutamente conoscere il contenuto del manuale prima di utilizzarlo.
- Il proprietario ha la responsabilità d'informare gli utenti sulle regole di sicurezza e controllare che siano rispettate.
- Mai usare il trampolino vicino all'acqua e mantenere libero uno spazio grande intorno al prodotto.
- Fare attenzione alle parti mobili. È possibile di lasciarci un braccio o una gamba.
- Non incollare niente sul trampolino.
- Non mettere assolutamente niente o nessuno sotto il trampolino.
- Il tappeto di salto è flessibile e le forze che vanno verso giù causate dal salto di un utente possono ferire la persona che si troverebbe sotto il trampolino.
- Bisogna conoscere i consigli di sicurezza presenti nel manuale.
- Il trampolino può essere utilizzato solo se il tappeto di salto è pulito e asciutto; un tappeto di salto danneggiato o troppo usato deve essere rimpiazzato subito.
- Gli oggetti pericolosi devono essere tolti dallo spazio riservato al trampolino
- Evitare un uso non autorizzato e non controllato del trampolino.
- Non usare il trampolino quando si è sotto l'impresa di alcol o di droga (tutte medicine che danno sonno, o che diminuiscono i riflessi).
- Cominciare con dei salti facili prima di provare quelli difficili.
- È consigliato di salire sul trampolino usando la scala e di non saltare direttamente sul trampolino. Non fare rimbalzare nessun oggetto sul trampolino.
- Per più informazioni sulle tecniche di salto vi dovete riferire ad un professore dotato di un certificato.
- Durante l'inverno, la neve e le temperature basse possono danneggiare il trampolino. Vi consigliamo di toliere la neve presente sul trampolino e di mantenere il tappeto di salto e la rete di sicurezza al riparo.
- Sempre controllare il suo trampolino prima ogni utilizzazione.



Le viti devono essere cambiate ogni due anni e anche la rete di sicurezza.

**I salti mortali:** Devono essere completamente evitati. Un atterraggio mancato può risultare in ferite gravi. Particolarmente ferite della spina dorsale, del collo e della testa. Queste ferite possono essere mortali oppure paralizzante. **PREVENTION DES ACCIDENTS :**

**Prevenzione degli incidenti:**

**Salto mortali e capriole:**

Mai fare salti mortali o capriole (avanti o indietro) per evitare ferite gravi, mortali o paralizzante del collo o della spina dorsale.

**Tante persone:**

Il rischio d'incidente è più alto se tante persone utilizzano il trampolino allo stesso tempo. Soprattutto senza avere un controllo sui salti. Gli utenti possono entrare in collisione o cadere dal trampolino. In generale, la persona più piccola si fa più male.

**Salire e scendere:**

Sempre salire e scendere dal trampolino con prudenza. Quando si sale non tirare sulla rete di protezione, non camminare sulle molle e non saltare sul trampolino da altri oggetti più alti per evitare le ferite. Eventualmente, è necessario aiutare i bambini per salire e scendere dal trampolino. Sempre tenersi alla struttura quando si scende dal trampolino. Quando si scende bisogna abbassarci e tenersi al bordo della struttura. E dopo scendere utilizzando la scala.

**Struttura e molle:**

Quando rimbalzate sul trampolino bisogna mirare il centro del tappeto di salto per non toccare la struttura e le molle. La struttura e le molle devono sempre essere coperte dal tappeto di protezione. Evitare di camminare sul tappeto di protezione perché non è stato concepito per quello.

**Perdita di controllo:**

La perdita di controllo sul trampolino può provocare un atterraggio pericoloso sul tappeto di salto, le molle o la struttura. Un salto controllato è un salto dove la persona è atterrata allo stesso posto di dove è partito il salto. Bisogna imparare i salti più facili prima di imparare quelli più difficili. Il rischio d'incidente è più alto quando l'utente è stanco.

**Droga e alcol:**

Il prodotto non deve essere utilizzato dalle persone che sono sotto l'influenza di droghe o alcol. Queste sostanze possono avere un impatto sulla visione, sul giudizio, sul tempo di reazione, la coordinazione e i riflessi motori della persona.

**Gli oggetti stranieri al kit:**

Non utilizzare il trampolino se c'è un cane o delle persone sotto. Non tenere nessun oggetto durante i salti e non mettere nessun oggetto sul trampolino mentre sta saltando. Togliere tutti i cavi o collegamenti che si trovano sopra il trampolino.

**Maltrattamento:**

Un maltrattamento del trampolino aumenta il rischio d'incidente. Verificare che il tappeto di salto sia in buona condizione prima ogni utilizzazione. Controllare che ci siano tutte le molle e che non siano rotte, controllare anche la stabilità del trampolino. Se c'è un danno bisogna rimpiazzare la parte danneggiata. Il trampolino non deve essere utilizzato se è danneggiato.

**Condizioni meteorologiche svantaggiose:**

Utilizzare il trampolino solo quando le condizioni meteorologiche sono vantaggiose. Un tappeto da salto bagnato è scivoloso. Con vento violento l'utente può perdere il controllo.

**Un accesso limitato:**

Mantenere la scala in un luogo sicuro quando non si usa il trampolino. Questo potrà evitare ai bambini di accedere al trampolino senza essere controllati da un adulto.

**Prevenire gli incidenti:**

Ruolo dell'utente:

Un minimo di conoscenza sul trampolino è necessario per utilizzarlo. Ogni utente deve avere un minimo di conoscenze delle tecniche di salto.

Ruolo del supervisore:

Il supervisore deve conoscere le istruzioni di sicurezza e controllare che siano applicate. Se il controllo del trampolino non è possibile, allora deve essere smontato e mantenuto in un luogo sicuro. Deve essere coperto da un telone sicuro con una catena chiusa con un lucchetto. Il supervisore deve anche controllare che le regole di sicurezza siano applicate sul trampolino.

**Consigli d'utilizzazione:**

Il trampolino deve solo essere utilizzato, qualsiasi sia il livello dell'utente, se è controllato da un adulto. L'utente del trampolino deve sapere controllare le tecniche di base. Dovete controllare i vostri salti. Non rimbalzare per troppo tempo. La stachezza aumenta il rischio d'incidente. Raccomandiamo ai principianti di mettere vestiti con le maniche lunghe per evitare le abrasioni.

**Montaggio del trampolino:**

Uno spazio libero di almeno 8 metri deve essere disponibile intorno al trampolino. Una distanza di sicurezza deve essere mantenuta tra il trampolino e tutti i pericoli (cavi elettrici, alberi, giochi, piscine, clotura...)

Il trampolino non deve essere messo sopra ad una superficie dura come l'asfalto, etc...

**Per favore assicurarsi che:**

1. Il trampolino sia piazzato su una superficie piatta e resistente.
2. Il trampolino sia piazzato in un luogo chiaro
3. Nessun oggetto sia vicino al trampolino.

**Manutenzione:**

Il trampolino deve essere controllato regolarmente e tutte le parti danneggiate devono essere rimpiazzate immediatamente. Il trampolino non deve essere utilizzato prima della riparazione completa.

Il trampolino è stato trattato contro la ruggine ma può apparire dove ci sono dei punti di collegamento o sotto le coperte di protezione. Per evitare la ruggine bisogna lubrificare regolarmente la struttura del trampolino e anche i pezzi di collegamento con della vaselina o altro lubrificante. Questo aumenterà la durata di vita della struttura.

Una manutenzione regolare è necessaria. Trascurare questa informazione mette gli utenti in pericolo. Le istruzioni di manutenzione devono essere applicate all'inizio di ogni stagione e durante tutto il periodo di utilizzazione.

Verificare il serraggio di ogni bullone e di ogni vite. Stringere se necessario.

Controllare che le estremità di ogni molla siano intatte e che non si possano distendere durante l'utilizzazione del trampolino.

Controllare il rivestimento di ogni bullone e bordo. Cambiarli se è necessario.

Mai modificare il trampolino. Usare solo i pezzi originali. Le riparazioni devono essere fatte da una persona qualificata. Una riparazione di fortuna può mettervi in pericolo.

Rispettate l'utilizzazione dei pezzi come nel manuale. Una manutenzione fatta male può risultare in un incidente. Controllate la presenza di danni.

## TECNICHE DI SALTO

Il rischio d'incidente è molto alto per i principianti, è importantissimo per loro d'imparare le tecniche, di base, di salto.

Consigliamo a tutti gli utenti di sapere controllare questi salti fondamentali.

### SALTO DI BASE :

- Comminciare in piedi. Tenere i piedi ad una larghezza di spalle e la testa che guarda il tappeto di salto
- Ribaltare le braccia in avanti e verso l'alto.
- Saltare con i piedi uniti e in punta.
- Atterrare con i piedi a larghezza di spalle.

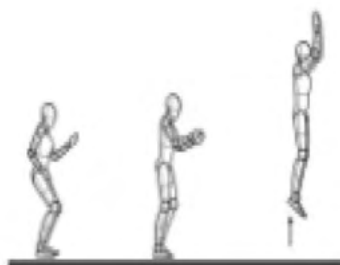

### INTERRUZIONE DI SALTO :

Può succedere che l'utente perda il controllo durante il salto. Per riprendere il controllo e l'equilibrio procedere come sotto :

Al momento dell'atterraggio, piegare le ginocchia al massimo. Questo permetterà d'interrompere il salto



### SALTO DI MANI E GINOCCHIA:

Cominciare con un salto di base basso e controllare.

Atterrare sulle mani e ginocchia e mantenere la schiena dritta.

Un'attenzione particolare deve essere fatta sull'atterraggio dei quattro punti.



**SALTO DI GINOCCHIA:**





Cominciare con un salto di base basso. Atterrare sulle ginocchia e mantenere la schiena dritta. Poi mettersi impiedi e mantenere l'equilibrio usando le braccia. Tornare alla posizione iniziale ribaltando le braccia.

**SALTO SUL SEDILE :**

Atterrare in posizione seduta con le gambe stese verso l'avanti. Durante l'atterraggio piazzare le mani piatte vicino ad ogni lato delle anche. Revenez à une position verticale (debout) en vous appuyant sur vos mains. Tornare ad una posizione verticale (in piedi) spingendo sulle mani.



















## ELENCO PARTI DEL TRAMPOLINO DA 8FT

1210_134631					
A1		Telaio di supporto	1220 mm	x6	1/2
B1		Materasso di		X1	1/2
C1		Tappeto di salto	2010mm	X1	1/2
D		Molle	145mm	X48	1/2
E		Estensione di	/	/	
F1		Piedi	1200mm	X3	1/2
G		Clip	45 mm	/	
H		Tirare il gancio		X1	1/2
I		Connettore		X6	1/2
J1		Rete di sicurezza	1800 mm	X1	1/2
K		Barra superiore	1070 mm	X6	2/2
L		Barra inferiore	1070 mm	X6	2/2
M		Clip	75 mm	X12	1/2
N		Attrezzo di serraggio		X1	1/2
O		Cap		X6	1/2
P1		Corda	7,7 milioni	X1	1/2
Q1		Asta in Fibra	104 cm	X6	1/2

2023-2024

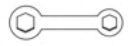















62

## ELENCO PARTI DEL TRAMPOLINO DA 10FT

1210_134632					
A2		Telaio di supporto	1500 mm	x6	1/2
B2		Materasso di		X1	2/2
C2		Tappeto di salto	2610 mm	X1	1/2
D		Molle	145 mm	X60	2/2
E		Estensione di	510 mm	X6	2/2
F2		Piedi	1500 mm	X3	1/2
G		Clip	45 mm	X6	1/2
H		Tirare il gancio		X1	1/2
I		Connettore		X6	1/2
J2		Rete di sicurezza	1800 mm	X1	1/2
K		Barra superiore	1070 mm	X6	2/2
L		Barra inferiore	1070 mm	X6	2/2
M		Clip	75 mm	X12	1/2
N		Attrezzo di		X1	1/2
O		Cap		X6	1/2
P2		Corda	9,5 m	X1	1/2
Q2		Asta in Fibra	101,5 cm	X8	1/2

















2023-2024

**ELENCO PARTI DEL TRAMPOLINO DA 12FT**

<b>1210_134633</b>					
<b>A3</b>		<b>Telaio di</b>	1400 mm	X8	1/3
<b>B3</b>		<b>Materasso di</b>		X1	1/3
<b>C3</b>		<b>Tappeto di</b>	3230 mm	X1	2/3
<b>D</b>		<b>Molle</b>	145mm	X72	2/3
<b>E</b>		<b>Estensione di</b>	510mm	X8	3/3
<b>F3</b>		<b>Piedi</b>	1400 mm	X4	1/3
<b>G</b>		<b>Clip</b>	45 mm	X8	1/3
<b>H</b>		<b>Tirare il gancio</b>		X1	1/3
<b>I</b>		<b>Connettore</b>		X8	2/3
<b>J3</b>		<b>Rete di</b>	1800mm	X1	2/3
<b>K</b>		<b>Barra</b>	1070 mm	X8	2/3
<b>L</b>		<b>Barra inferiore</b>	1070 mm	X8	2/3
<b>M</b>		<b>Clip</b>	75 mm	X16	1/3
<b>N</b>		<b>Attrezzo di</b>		X1	1/3
<b>O</b>		<b>Cap</b>		X8	2/3
<b>P3</b>		<b>Corda</b>	11,5 m	X1	2/3
<b>Q3</b>		<b>Asta in Fibra</b>	101 cm	X10	2/3



## ELENCO PARTI DEL TRAMPOLINO DA 14FT

1210_134634					
A4		Telaio di supporto	1620 mm	X8	1/3
B4		Materasso di		X1	2/3
C4		Tappeto di salto	3830 mm	X1	1/3
D		Molle	145mm	X80	2/3
E		Estensione di	510mm	X8	3/3
F4		Piedi	1620 mm	X4	2/3
G		Clip	45 mm	X8	2/3
H		Tirare il gancio		X1	2/3
I		Connettore		X8	2/3
J4		Rete di sicurezza	1800 mm	X1	2/3
K		Barra superiore	1070 mm	X8	3/3
L		Barra inferiore	1070 mm	X8	3/3
M		Clip	75 mm	X16	2/3
N		Attrezzo di		X1	2/3
O		Cap		X8	2/3
P4		Corda	13,5 m	X1	2/3
Q4		Asta in Fibra	100 cm	X12	2/3

2023-2024

65

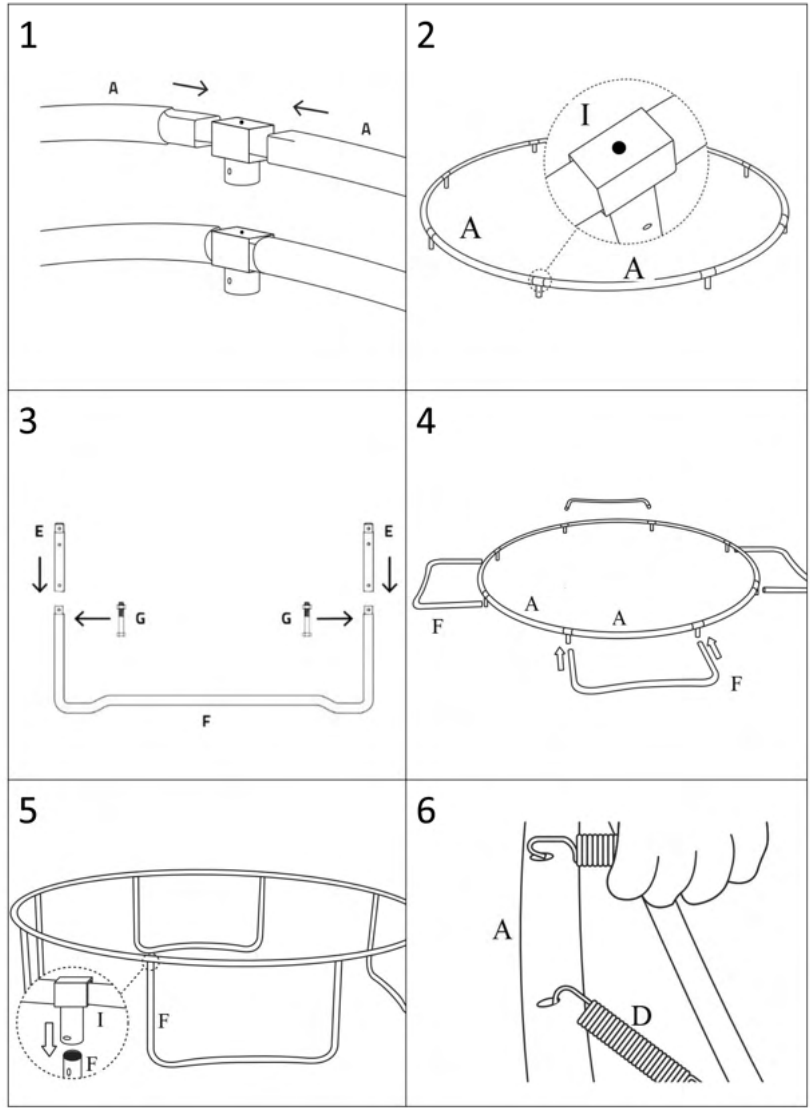

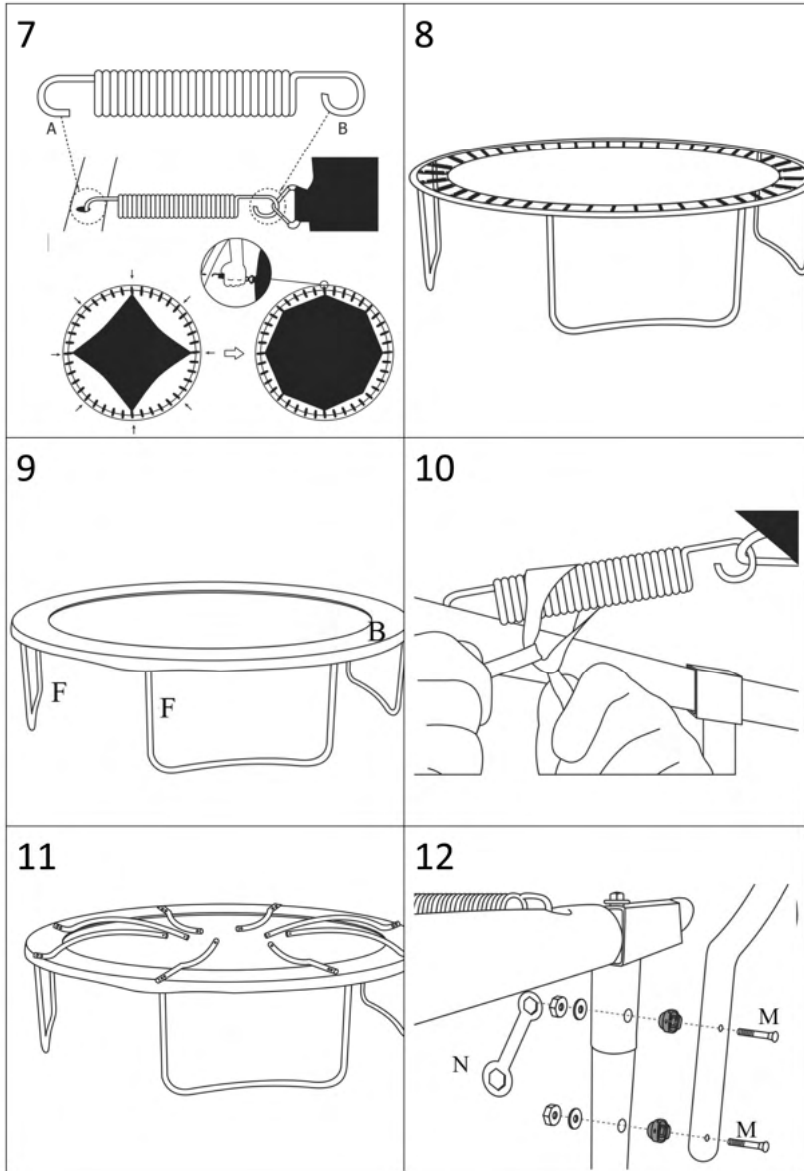

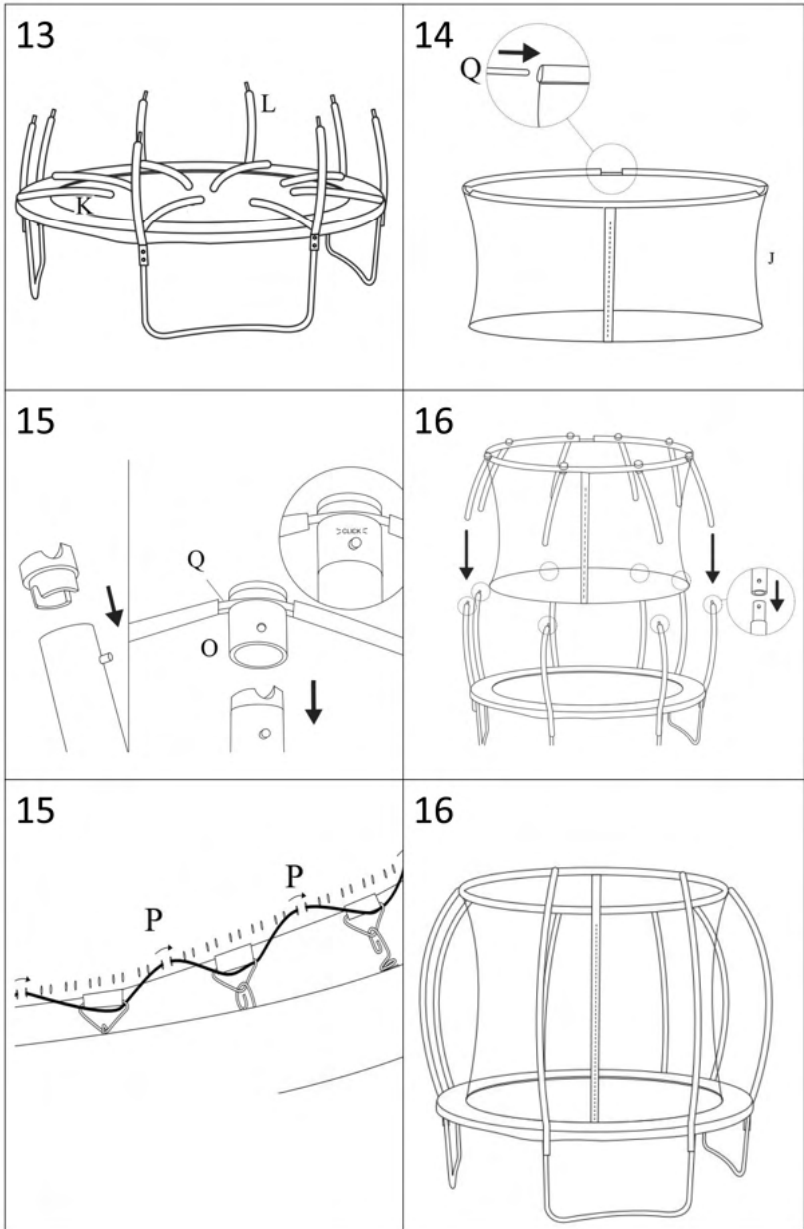

**Responsable de la commercialisation du produit / Company  
in charge of commercializing the product / Responsable de  
la comercialización del producto:**

GECODIS SA  
32, rue de paradis  
75010, Paris, France

**Service commercial/ Commercial service/ Servicio comercial :**

Habitatetjardin.com  
32, rue de paradis  
75010, Paris, France

**Assistance : +33 (0) 1 47 70 33 64**

**Service après-vente/ After sale services/ Servicio post-venta :**

GECODIS SA  
32, rue de paradis  
75010, Paris, France

<http://sav.habitatetjardin.com>

Attention ! Ne convient pas aux enfants de moins 3 ans.  
Petites parties – Danger d'étouffement.  
Présence de cordes – Danger de strangulation.



Warning! Not suitable for kids under 3 years old.  
Tiny pieces – Danger of suffocation.  
Presence of rope – Danger of strangulation.



¡Advertencia! No es adecuado para niños menores de 3 años.  
Piezas pequeñas – Peligro de asfixia.  
Contiene cuerdas – Peligro de estrangulación.



Attenzione! Non adatto per i bambini sotto i 3 anni.  
Piccoli pezzi- Pericolo di soffocamento.  
Presenza di Rope- Pericolo di strangolamento.



FR : SAV/INFORMATION /VIDEO/CONTACT  
EN : AFTER-SALES SERVICE/INFORMATION/VIDEO/CONTACT  
DE : REPARATUR-SERVICE UND ERSATZTEILE /INFORMATIONEN /VIDEO/KONTAKT  
ES : SERVICIO POST-VENTA/INFORMACIÓN/VIDEO/CONTACTO  
IT : SERVIZIO ASSISTENZA/INFORMAZIONI/VIDEO/CONTATTO  
PT : SERVIÇO PÓS-VENDA/INFORMAÇÕES/VIDEO/CONTATO  
PL : SERWIS TECHNICZNY/INFORMACJE/WIDEO/KONTAKT  
NE : AFTER SALES SERVICE/INFORMATIE/VIDEO/CONTACT  
HE: עם תקשר/הווידיאו/ מידע/מכירות שירות לאחר

**SAV.HABITATETJARDIN.**

2023-2024

69

