

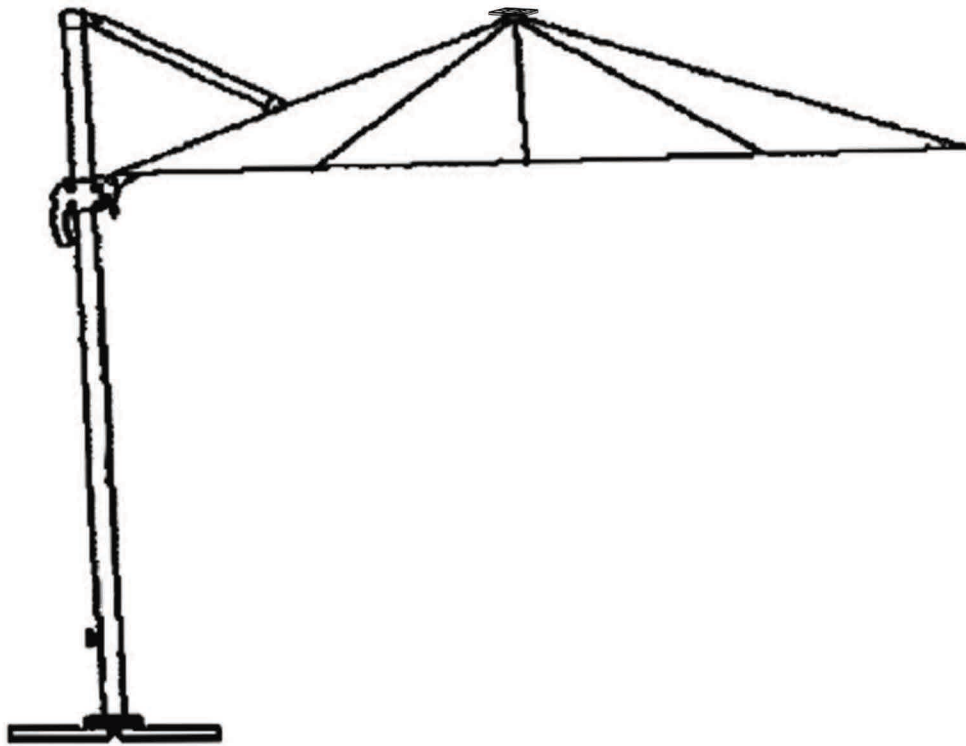

















Sun 4 Luxe

1165_99939/1165_99940/1165_99941/1165_102997



1165_99939/99940/99941/102997

A4		1000mm	X1	1/1
B4		1000mm	X1	1/1
C		400mm	X1	1/1
D		130x50mm	X1	1/1
E		M8x14mm	X8	1/1
F		M8	X8	1/1
G		150x80mm	X1	1/1
HRL4		RIBS	X1	1/1
HD4		Diagonal	X1	1/1
HDT4		Diagonal tie	X1	1/1
HP4		2600mm	X1	1/1
HC4		2600mm	X1	1/1
I		120mm	X1	1/1
J		Ø 30x40mm	X1	1/1
L		140x140mm	X1	1/1
K		M6	X1	1/1
M		USB	X1	1/1

FR : SAV/INFORMATION /VIDEO/CONTACT
 EN: AFTER-SALES SERVICE/INFORMATION/VIDEO/CONTACT
 DE : REPARATUR-SERVICE UND ERSATZTEILE //INFORMATIONEN /VIDEO/KONTAKT
 ES: SERVICIO POST-VENTA/INFORMACIÓN/VIDEO/CONTACTO
 IT: SERVIZIO ASSISTENZA/INFORMAZIONI/VIDEO/CONTATTO
 PT: SERVIÇO PÓS-VENDA/INFORMAÇÕES/VIDEO/CONTATO
 PL: SERWIS TECHNICZNY//INFORMACJE/WIDEO/KONTAKT
 NE: AFTER SALES SERVICE//INFORMATIE/VIDEO/CONTACT
 HE: עם לתקשר/הווידיאו/ מידע/ומכירות שירות לאחר

SAV.HABITATETJARDIN.COM

2019-2020

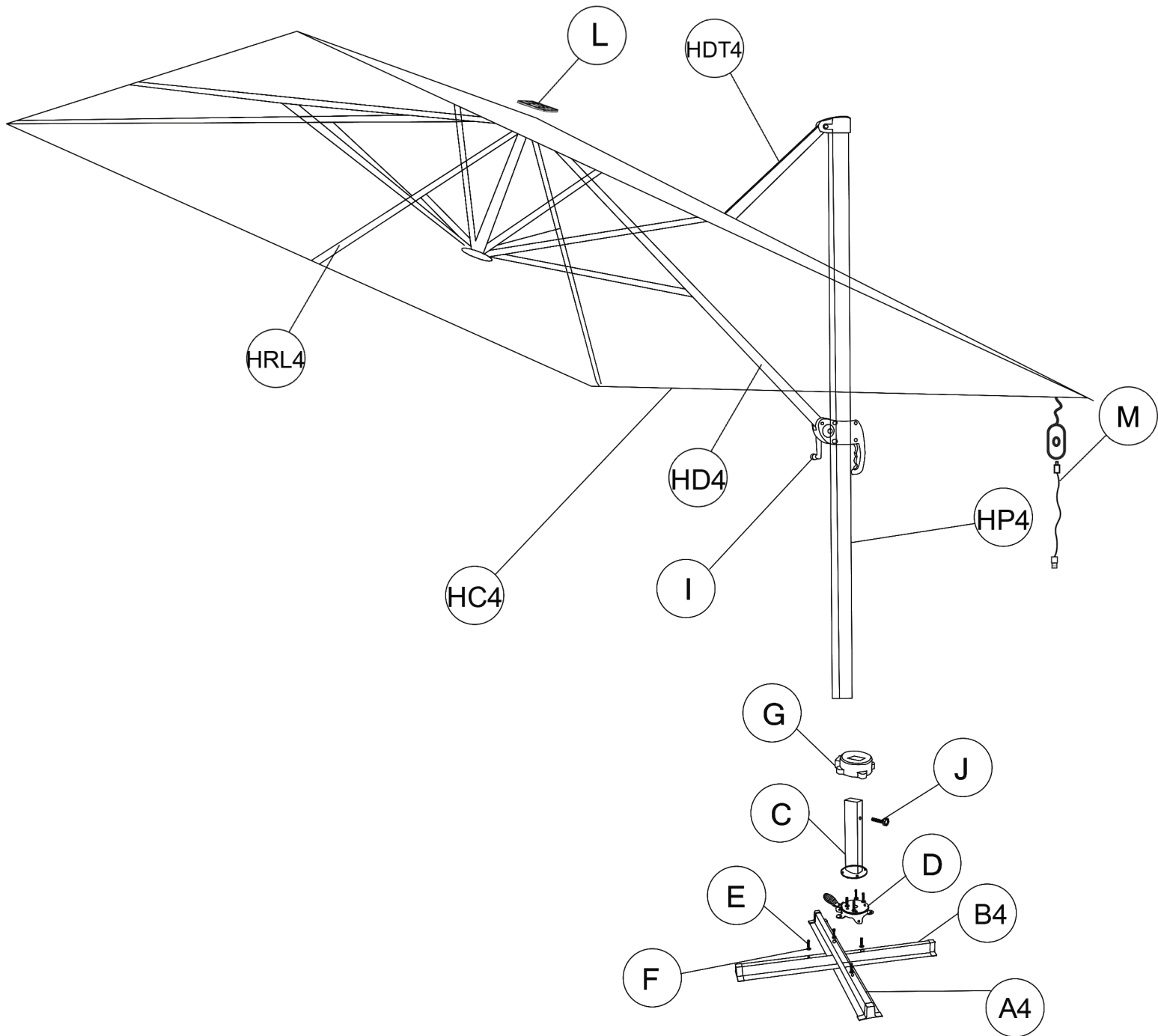

FR

- Il est conseillé d'attendre d'avoir monté entièrement votre produit avant de serrer complètement vos vis.
- Il est conseillé une housse de protection pour éviter des intempéries et poussière
- En hiver, stockez dans un endroit abrité et sec
- Pensez à fermer et à ranger votre parasol à l'abri dans un endroit sec lorsque vous ne l'utilisez pas.
- Pour stabiliser vos parasols, des dalles sont disponibles sur notre site d'internet.

EN

- It is advisable to wait until you have fully assembled your product before tightening your screws completely.
- It is advisable to put your products into cover to protect them from the severe weather and dust.
- In winter, store your products in a dry place.
- Remember to close and store your umbrella in a dry place when not in use.
- To stabilize your parasols, slabs are available on our website.

DE

- Es ist ratsam, für Ihre vollständig montiert zu warten, bevor vollständig Ihre Schrauben festziehen.
- Es wird empfohlen, Ihre Produkte mit einer Schutzabdeckung zum Schutz vor Witterung und Staub zu schützen.
- Im Winter, speichern Sie Ihre Waren an einem trockenen Ort.
- Denken Sie daran, Ihren Regenschirm schließen und zu speichern weg an einem trockenen Ort, wenn sie nicht in Gebrauch ist.
- Ihre Regenschirme zu stabilisieren, Fliesen sind auf unserer Website zur Verfügung.

ES

- Se aconseja montar totalmente el producto antes de apretar completamente todos los tornillos.
- Se aconseja cubrir los productos con una funda para protegerlos de las intemperies y del polvo.
- En invierno, almacene los productos en un lugar seco.
- Cierre y almacene su sombrilla en un lugar seco cuando no lo utilice.
- Para estabilizar su sombrilla tenemos lastres disponibles a la venta en nuestra página web.

IT

- È consigliato di aspettare di avere montato interamente il prodotto prima di stringere completamente le viti.
- È consigliato di proteggere i prodotti con un sacco di protezione per preservarli dal brutto tempo e dalla polvere.
- Durante l'inverno, mettere i prodotti al riparo in un luogo secco.
- Pensare di chiudere e di mettere al riparo l'ombrellone quando non serve.
- Per stabilizzare gli ombrelloni, delle lastre sono disponibili sul nostro sito internet.

①

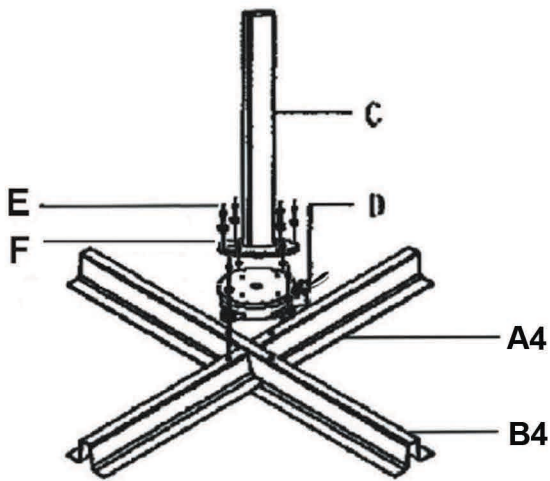

②

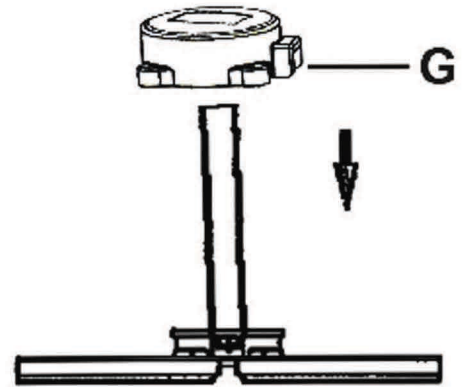

③

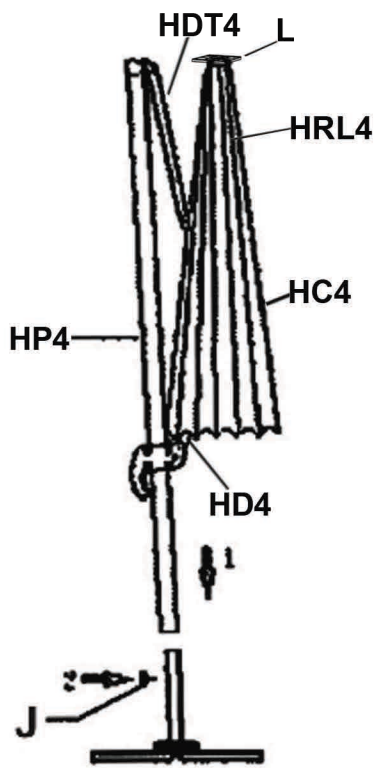

④

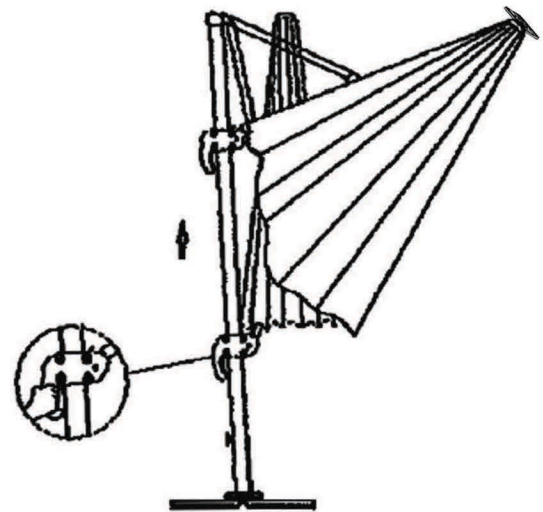

⑤

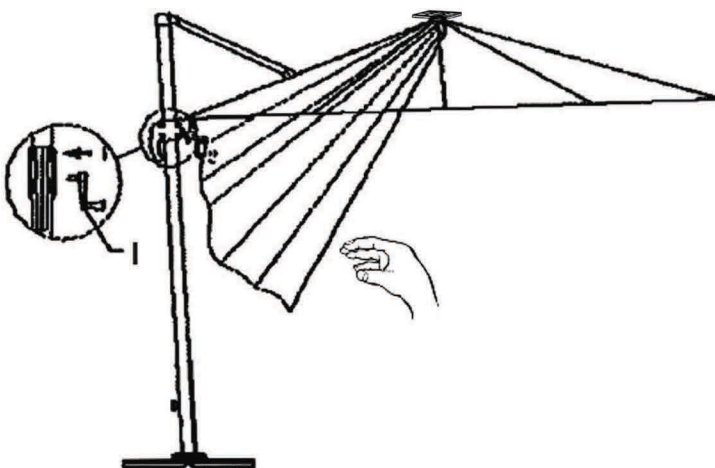

⑥

