

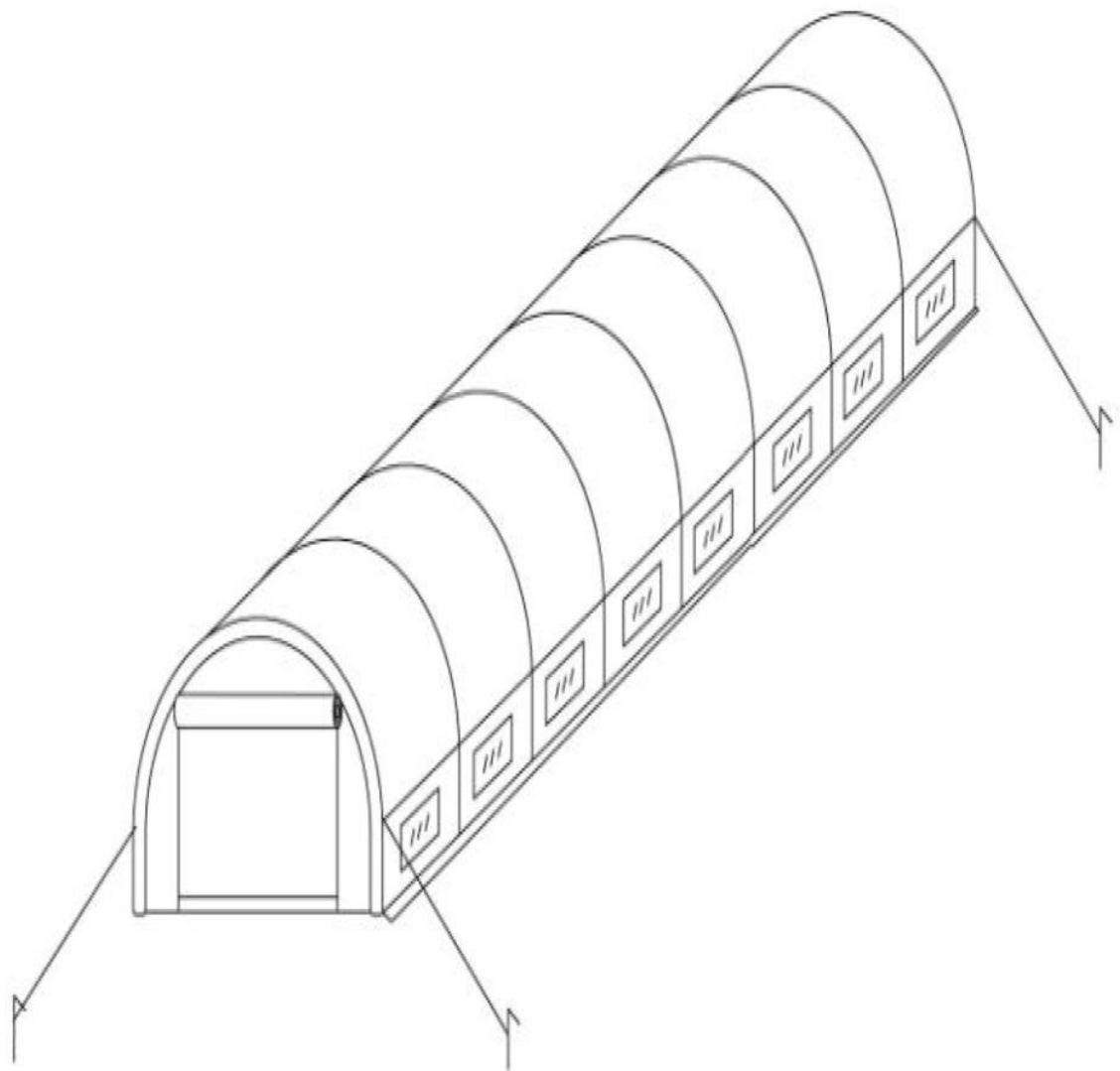











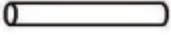
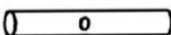

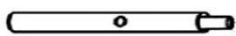
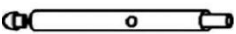



Althea

1257_67274



1257_67274				
1		1200mm	X 36	1/1
2		500mm	X 9	1/1
3		515mm	X 9	1/1
4		970mm	X 5	1/1
4A		970mm	X 2	1/1
5		1040mm	X 25	1/1
6		1040mm	X 10	1/1
7		1040mm	X 10	1/1
8		1040mm	X 4	1/1
9		990mm	X 4	1/1
10		1040mm	X 2	1/1
11		1132 mm	X 4	1/1
12		M6X58mm	X 63	1/1
13		M6X30mm	X 4	1/1
14			X 67	1/1
15		66mm	X 1	1/1
16		73mm	X 1	1/1
17		170mm	X 20	1/1
18		2400mm	X 4	1/1
19			X 1	1/1

FR : SAV/INFORMATION /VIDEO/CONTACT

EN: AFTER-SALES SERVICE/INFORMATION/VIDEO/CONTACT

DE : REPARATUR-SERVICE UND ERSATZTEILE /INFORMATIONEN /VIDEO/KONTAKT

ES: SERVICIO POST-VENTA/INFORMACIÓN/VIDEO/CONTACTO

IT: SERVIZIO ASSISTENZA/INFORMAZIONI/VIDEO/CONTATTO

PT: SERVIÇO PÓS-VENDA/INFORMAÇÕES/VIDEO/CONTATO

PL: SERWIS TECHNICZNY/INFORMACJE/WIDEO/KONTAKT

NE: AFTER SALES SERVICE/INFORMATIE/VIDEO/CONTACT

HE: עם לתקשר/הוידאו/ מידע/ומכירות שיחת לאחר

SAV.HABITATETJARDIN.COM

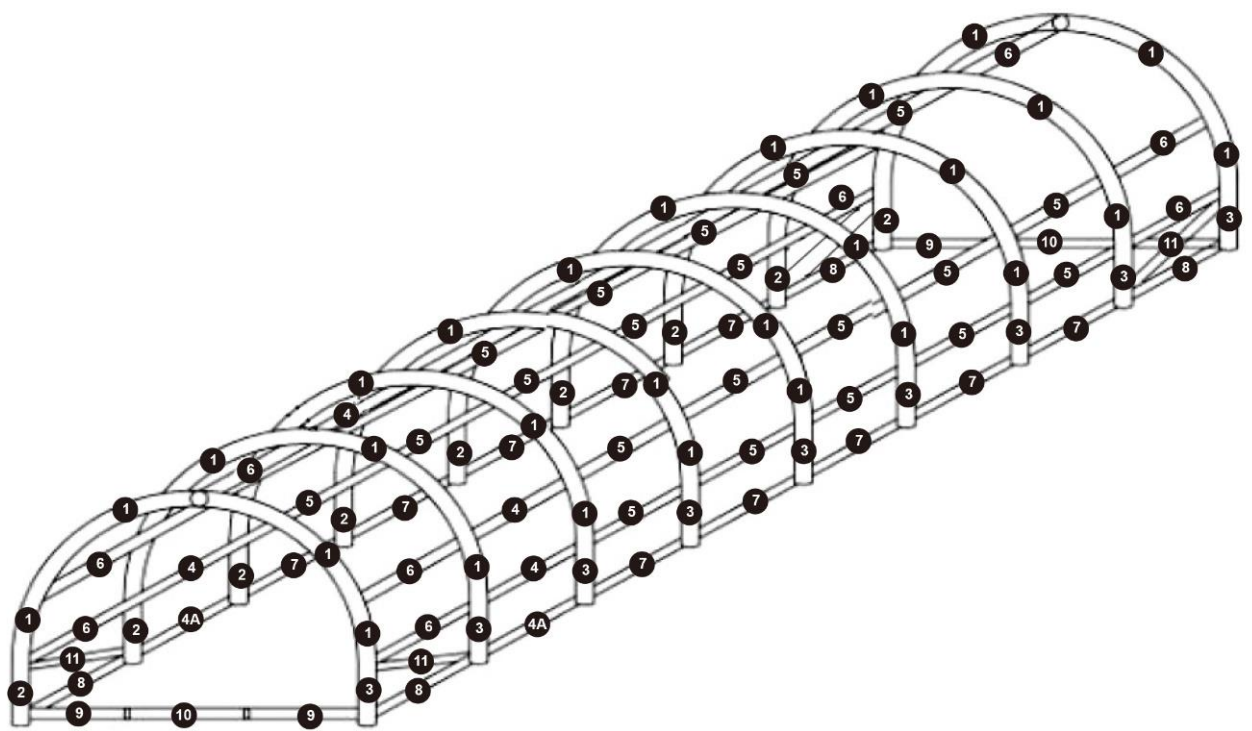

EN:

Read the following instructions carefully, before assembling your greenhouses.

A: Assemble Parts

A1: Assemble the frame exactly as in manual.

A2: Before putting the cover, open all zippers and gently adjust the cover with the frame, close all zippers and double check every detail. Put the cover carefully and

gently. 

A3: Please try to install your greenhouse away from direct wind.

B: Checking

B1: If you find a thread "unsewn", stop using the greenhouse, then sew the seam and stick a transparent adhesive tape on the seam to protect it.

B2: Zippers: Pull gently and use wax polish on the zippers, then use smoothly to be durable.

B3: Please put more soil on the grounded part of the cover and put ground pegs to fix cover.

B4: Please open windows on both sides to keep wind ventilation.

C: Maintenance

C1: When wind speed excess 24 miles/hour, secure your greenhouse with extra ropes and press on top of the cover with unused cloth or film.

C2: Please keep your greenhouse clear of snow and water. 

C3: Maximum Load is 100kgs for polytunnel greenhouses, never overload  

C4: Don't spread chemical fertilizer and pesticides on the covers and tubes. 

C5: If you won't use the greenhouse for a long time, clean and pack it in the original carton, then put it in a protected and cool place.



FR:

Lire attentivement les instructions ci-dessous avant d'assembler la serre.

A: Assemblage

A1 : Assemblez la structure exactement comme indiqué dans la notice.

A2 : Avant de mettre la bâche, ouvrez tous les zips et ajustez la bâche à la structure avec délicatesse. Ensuite, fermez les zips et revérifiez chaque partie de la serre.

Installez la bâche en faisant très attention à celle-ci, ne pas forcer. 

A3 : Ne pas assembler la serre dans un endroit où il y a du vent.

B : Vérification

B1 : Si un fil est décousu, arrêtez d'utiliser la serre. Il faut recoudre la couture et mettre du ruban adhésif pour la protéger.

B2 : Fermetures éclairées : Tirez dessus avec beaucoup de délicatesse et mettez de la cire sur les zips pour avoir un produit durable.

B3 : Mettre de la terre sur les parties de la bâche qui sont au sol et installer un kit d'ancrage.

B4: Laisser les fenêtres ouvertes des deux côtés pour avoir une bonne ventilation.

C: Maintenance

C1: Quand le vent dépasse les 40 km/h, il faut sécuriser la serre avec des cordes supplémentaires et mettre sur la bâche une toile ou un film protecteur.

C2: Il ne doit pas y avoir un excédent d'eau et de neige sur la bâche et dans la serre. 



C3: Le poids maximum pour la serre tunnel est de 100 kgs, ne jamais surcharger.

C4: Il ne faut jamais asperger la bâche et les tuyaux de la serre avec des fertilisants

chimiques et des pesticides. 

C5: Si la serre ne sera pas utilisée pendant quelques mois, il faut la nettoyer à l'eau et la remettre dans son emballage d'origine, puis il faut la stocker dans un lieu protégé et frais.



ES :

Lea cuidadosamente las siguientes instrucciones antes de empezar a montar el invernadero.

A: Ensamblaje de piezas

A1: Ensamblar la estructura exactamente como se indica en el manual de instrucciones.

A2: Antes de incorporar el film, abrir todos los compartimientos (ventanas, puerta) y cuidadosamente ajustar el film a la estructura, cerrar los compartimientos y verificar

nuevamente cada detalle. Fijar el film delicadamente.



A3: Por favor instalar el invernadero apartado del viento directo.

B: Verificación

B1: Si encuentra que el film se ha descocido, deje de usar el invernadero y cocer la parte afectada, enseguida pegue una cinta adhesiva para protegerlo.

B2: Compartimientos: Utilice cuidadosamente las pegatinas de modo que tenga mayor duración.

B3: Incorporar tierra en la parte baja del film y poner las clavijas para fijarlo.

B4: Por favor abrir las ventanas de ambos lados para mantener el producto ventilado.

C: Mantenimiento

C1: Si la velocidad del viento excede los 38 Km/h, asegure el invernadero con cuerdas e incorpore otra cubierta por encima.

C2: Por favor mantener el invernadero limpio de nieve y agua.



C3: Carga máxima 100kgs, no sobrecargarlo.



C4: No esparcir fertilizantes químicos o pesticidas sobre los tubos ni sobre el film.



C5: Si no va a utilizar el invernadero por un largo periodo de tiempo, se recomienda que lo limpie, lo empaque y lo conserve en un lugar seco.



IT :

Leggere le istruzioni di montaggio prima di assemblare la serra.

A: Montaggio

A1: Assemblare la struttura esattamente come indicato nel manuale d'istruzioni.

A2: Prima di mettere il telone, bisogna aprire tutte le cerniere e sistemare con delicatezza il telone sulla struttura, poi chiudere le cerniere e verificare che tutto sia

apposto. 

A3: Non montare la serra dove c'è vento.

B: Verificazioni

B1: Se un filo è scucito, non bisogna più utilizzare la serra, poi si deve cucire il filo di nuovo e incollare con un nastro adesivo la cucitura per proteggerla.

B2: Cerniere: Aprire delicatamente e utilizzare cera sulle cerniere, per assicurare un'utilizzazione durevole.

B3: Mettere terra sulle parti del telone che toccano il suolo e mettere dei picchetti per mantenere il telone.

B4: Aprire le finestre sui due lati per avere una buona ventilazione.

C: Manutenzione

C1: When wind speed excess 24 miles/hour, secure your greenhouse with extra ropes and press on top of the cover with unused cloth or film. Se c'è vento forte (più di 40 km/h), bisogna securizzare la serra con corde e bisogna mettere sopra il telone delle coperte o film.

C2: Non ci deve essere acqua o neve sulla serra. 

C3: Il carico massimo per una serra è di 100 kg, non si deve mai sovraccaricare. 



C4: Non mettere fertilizzanti chimici e pesticidi sul telone e sui tubi. 

C5: Se non si deve usare la serra per qualche mese, bisogna pulirla e confezionarla nella scatola di origine, poi bisogna metterla in un uogo protetto e fresco.



1.

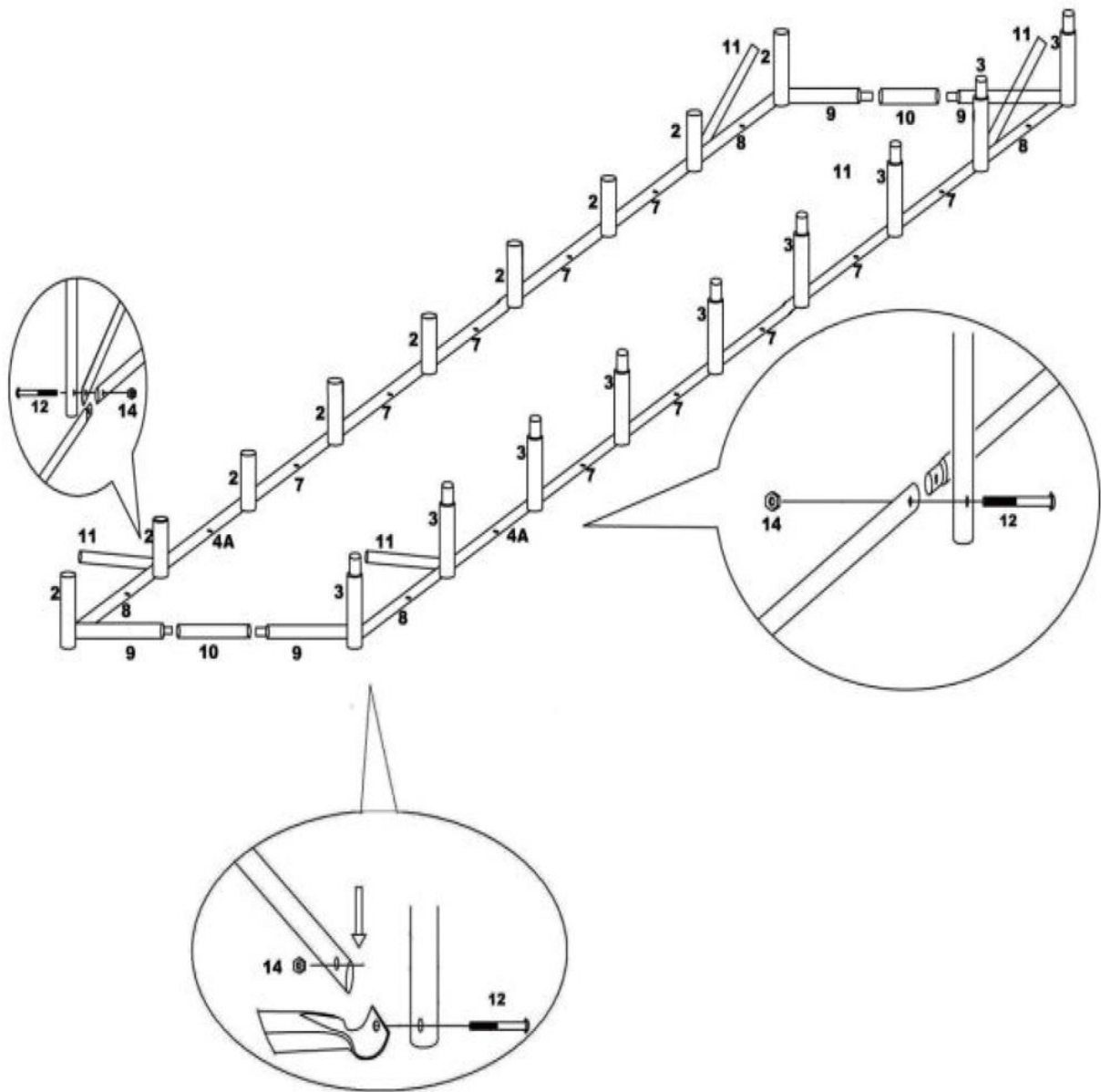

2.

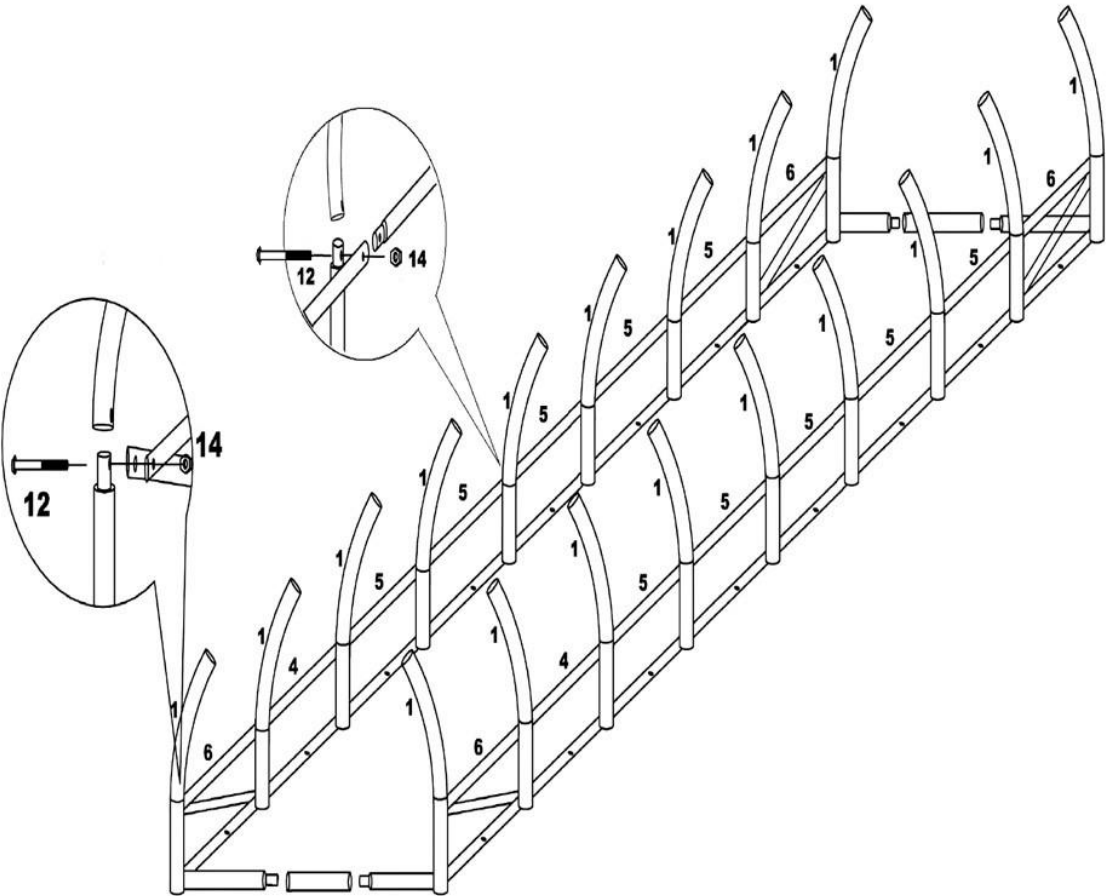

3.

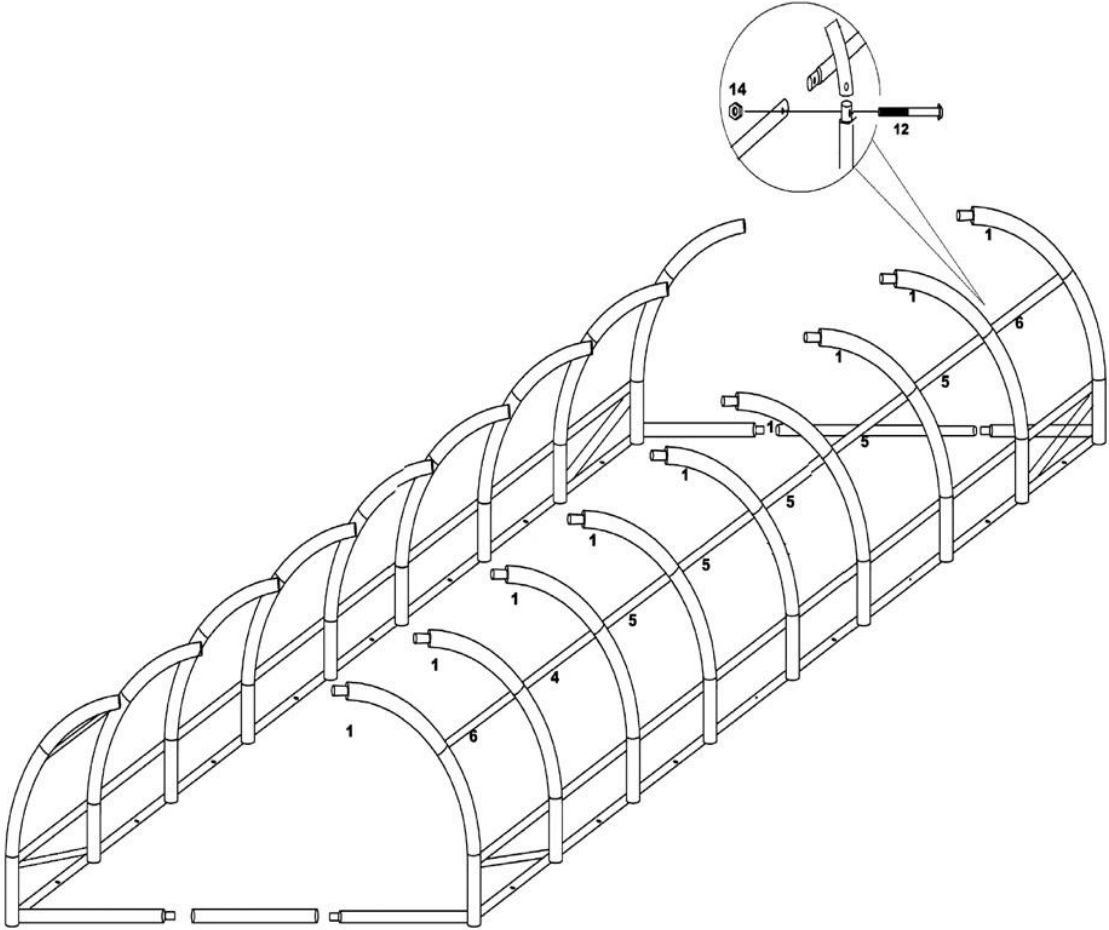

4.

